

A a

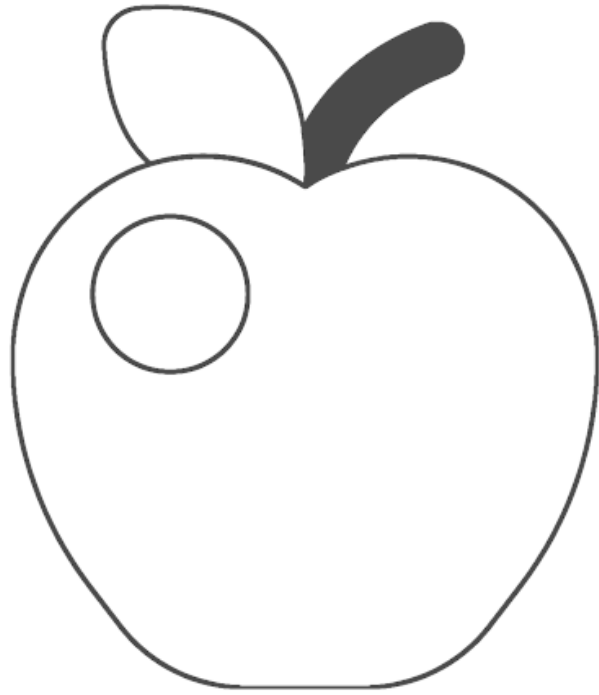

apple

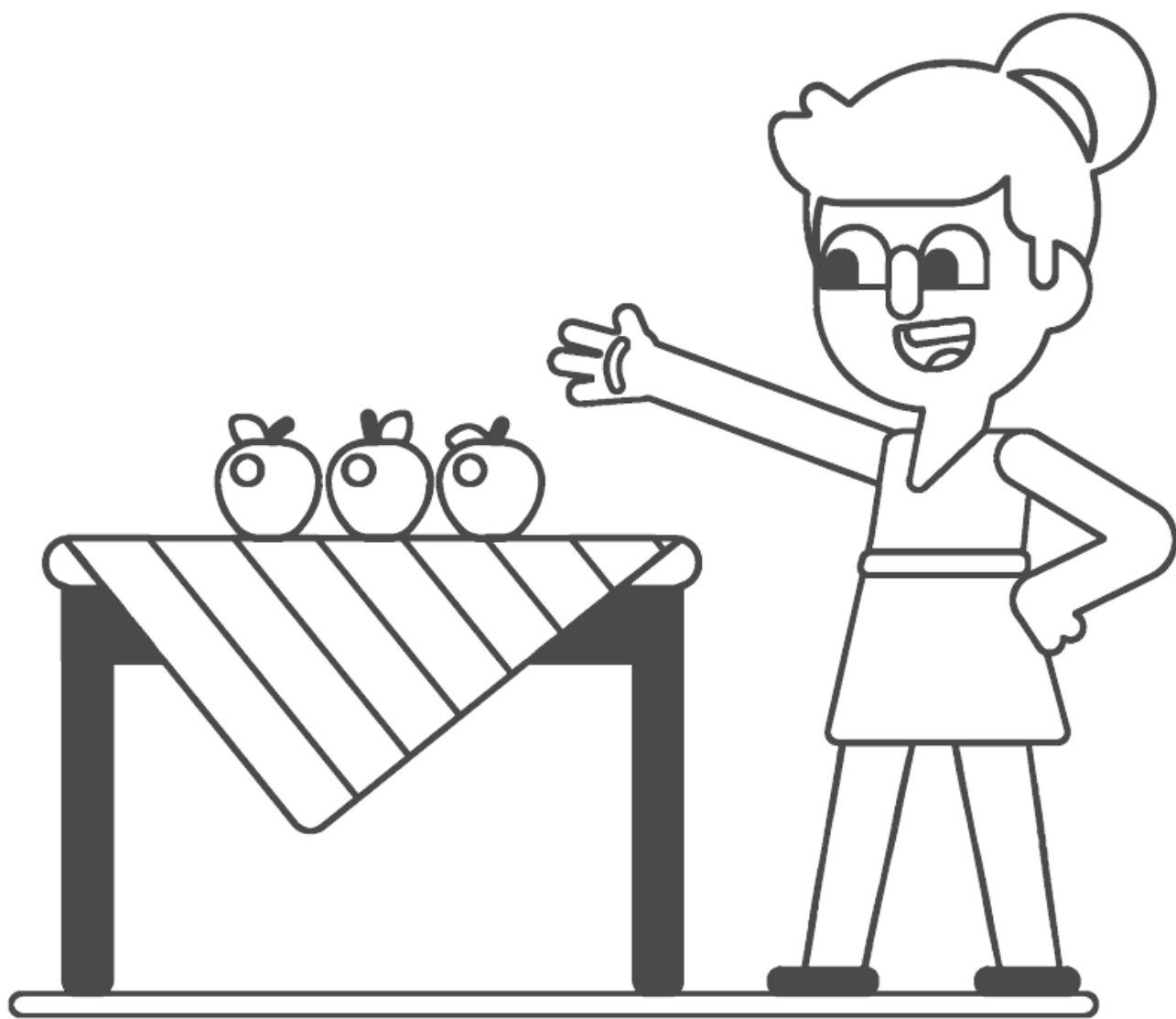

I see three apples.

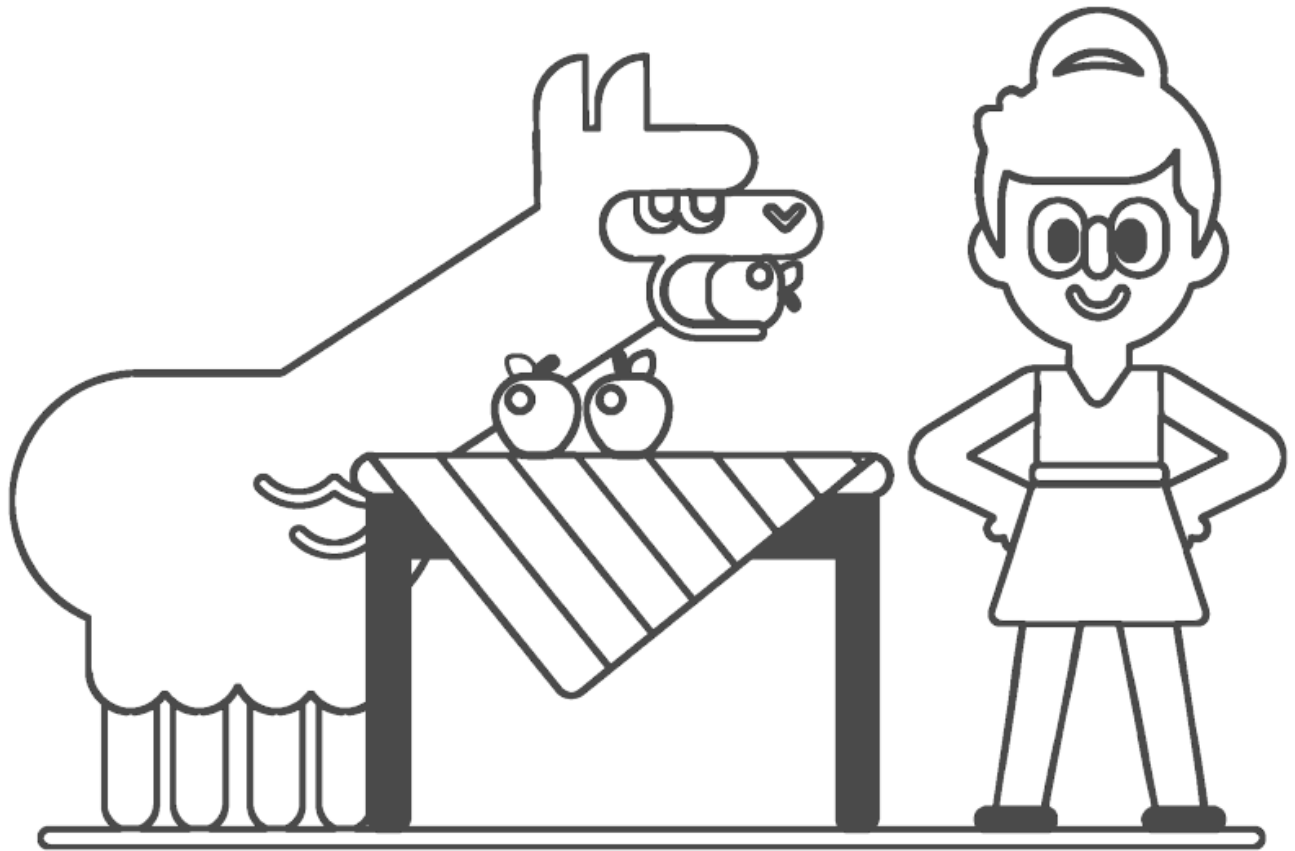

I see two apples.

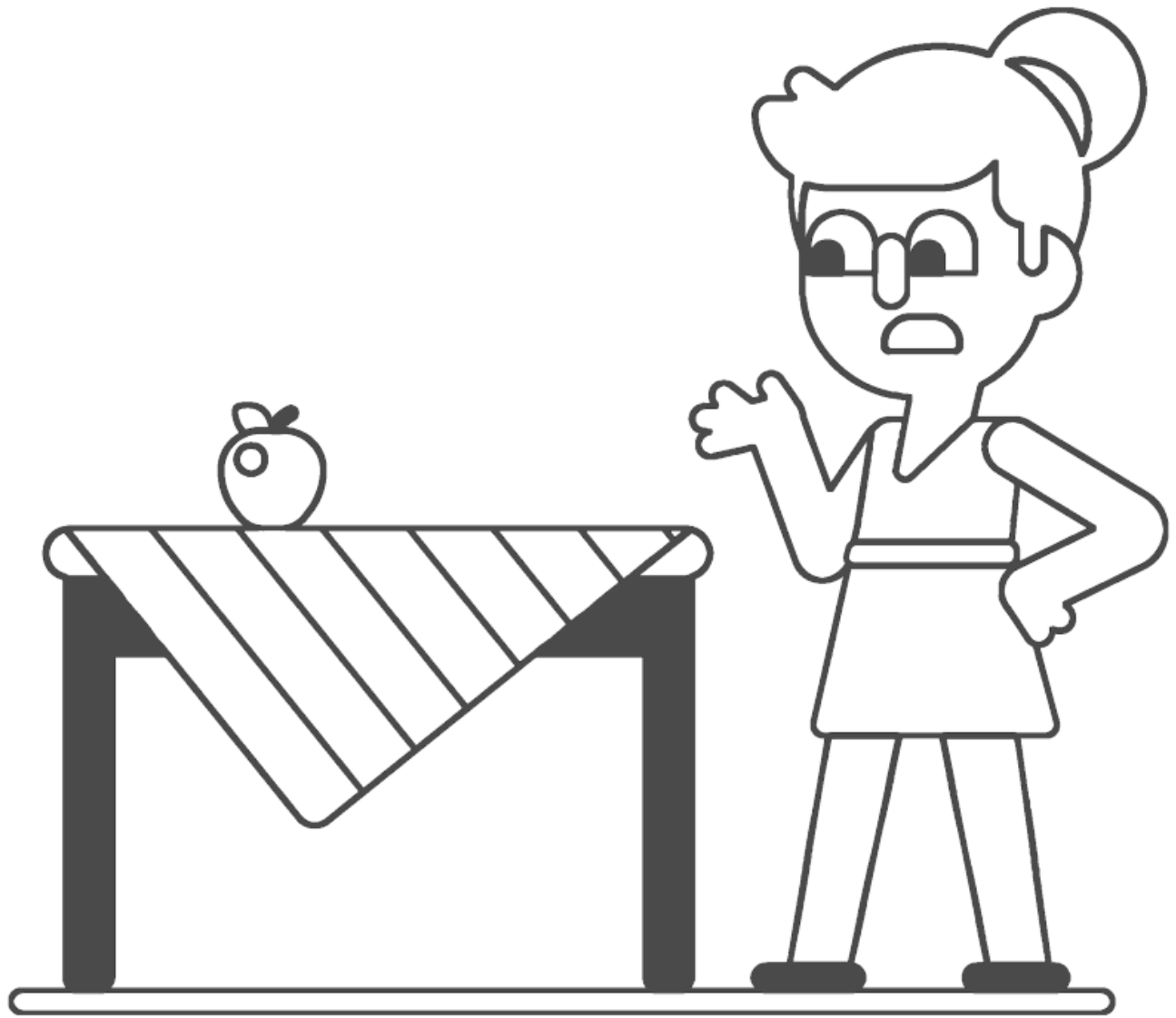

I see one apple.

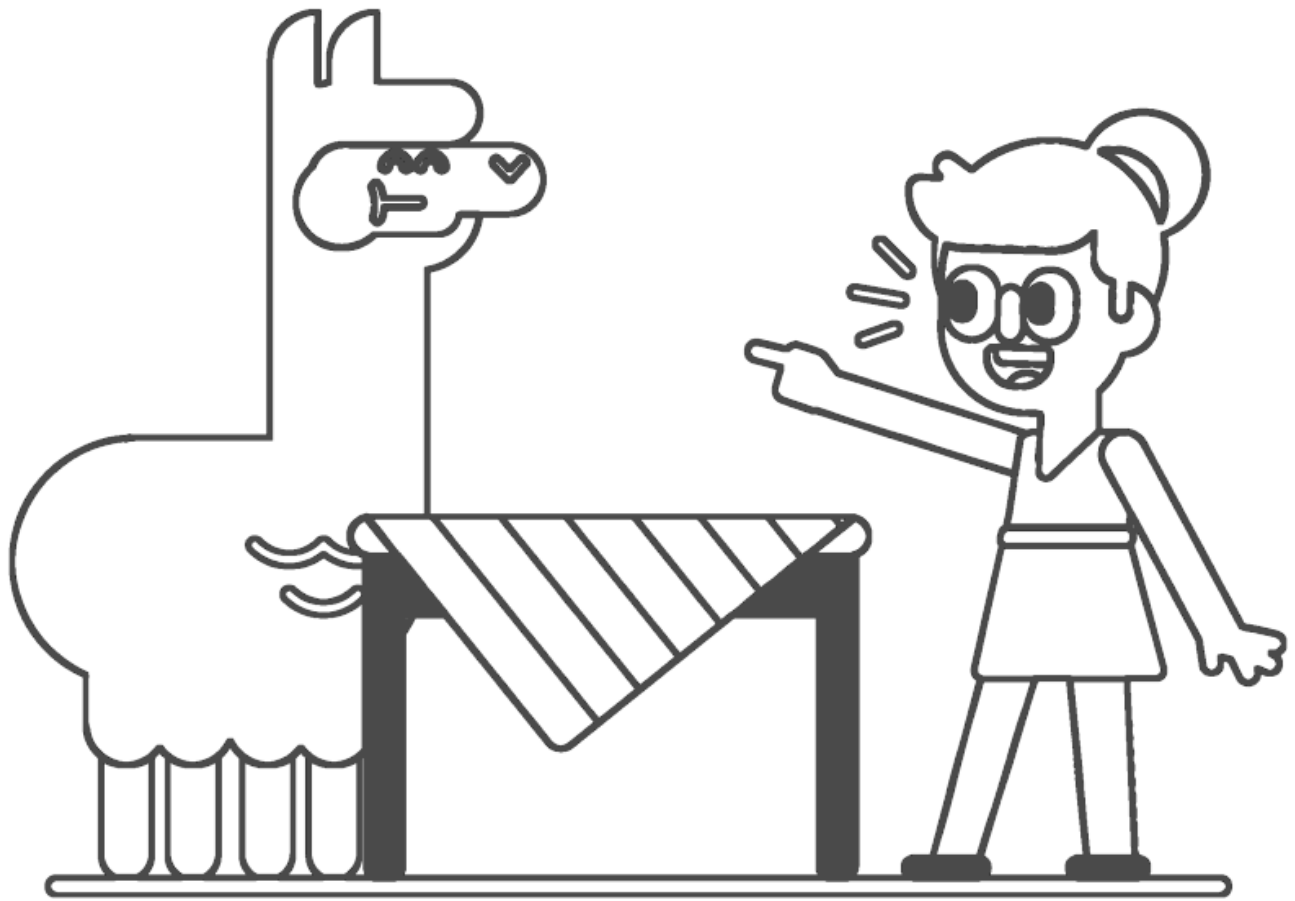

I see an alpaca!

B b

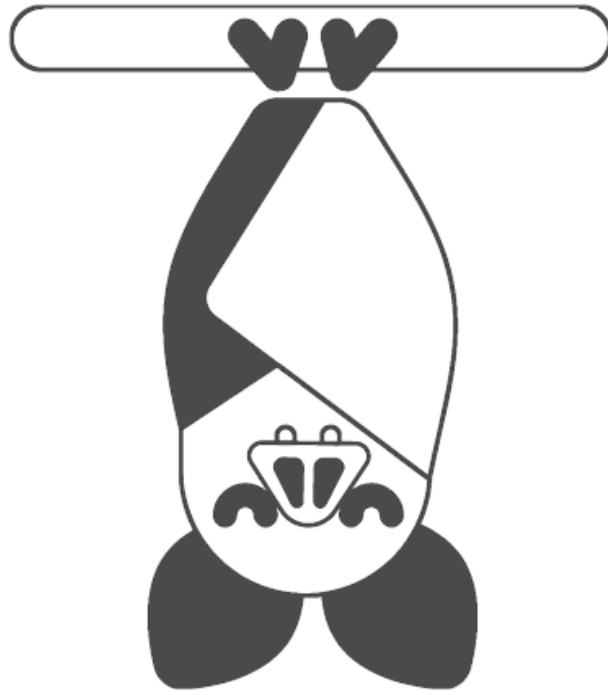

bat

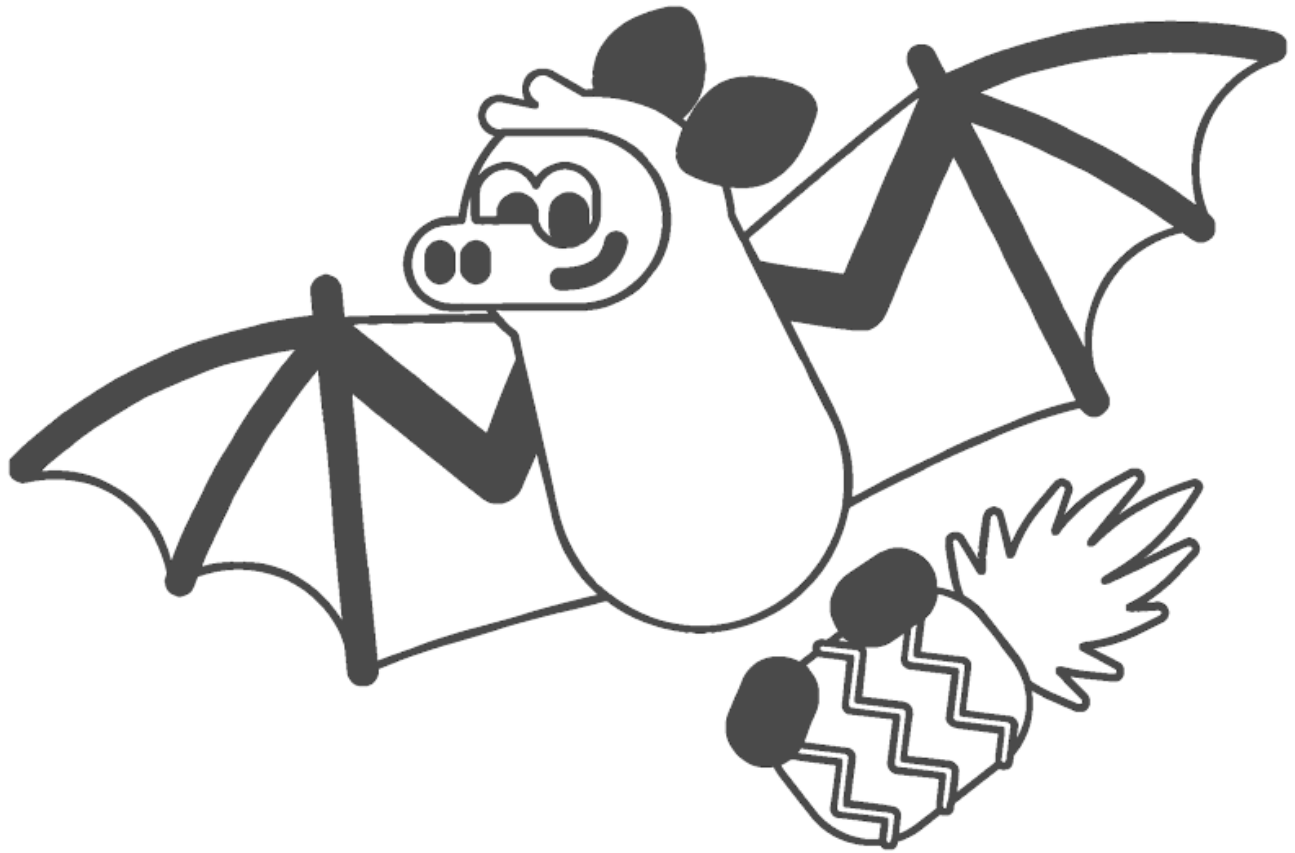

Some bats are big.

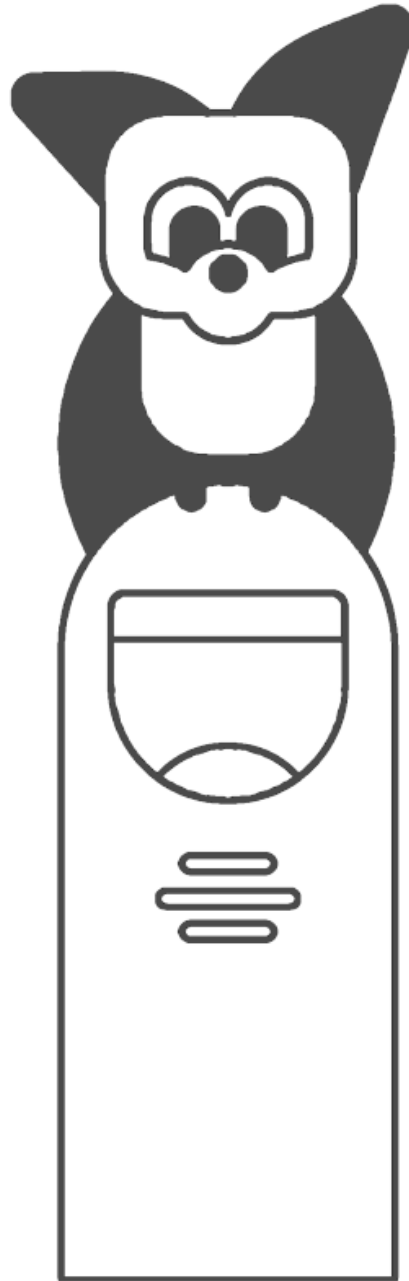

Some bats are small.

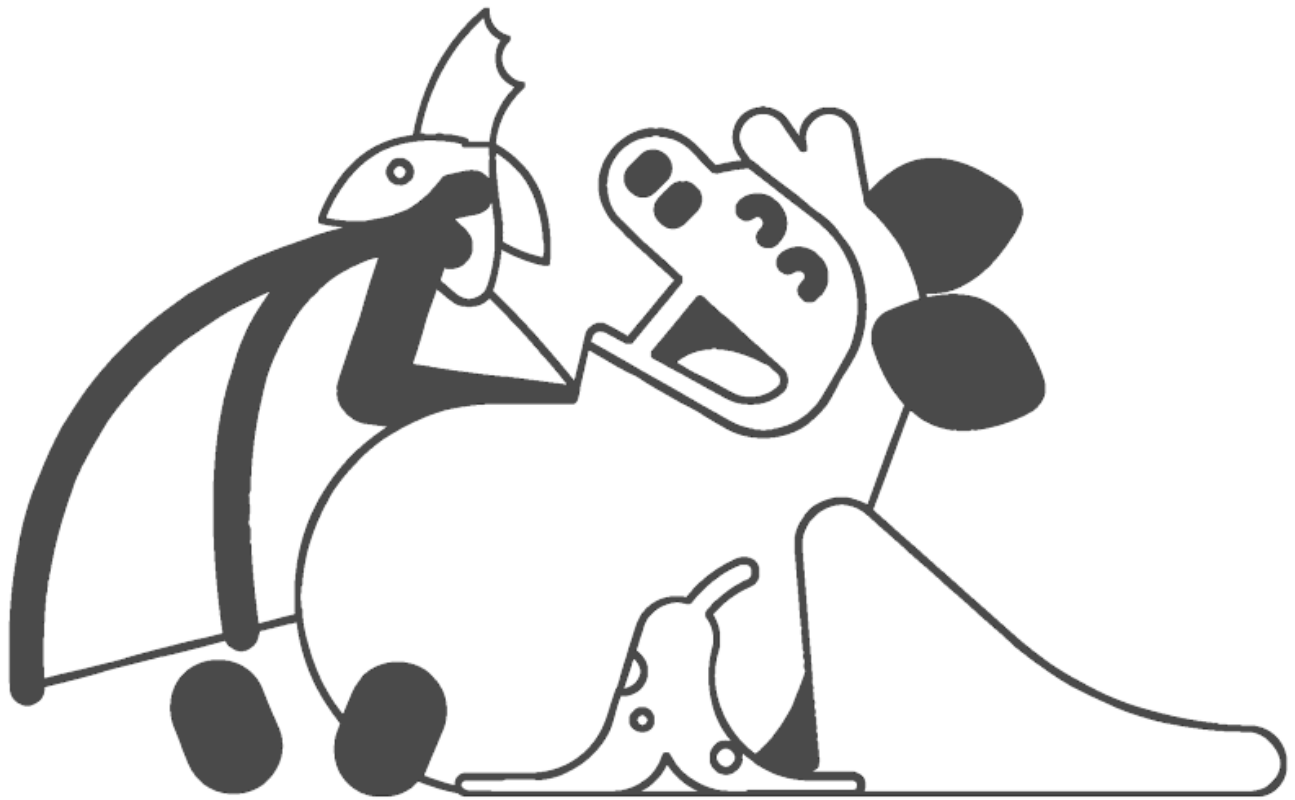

**Some bats eat
bananas.**



Some bats eat bugs.

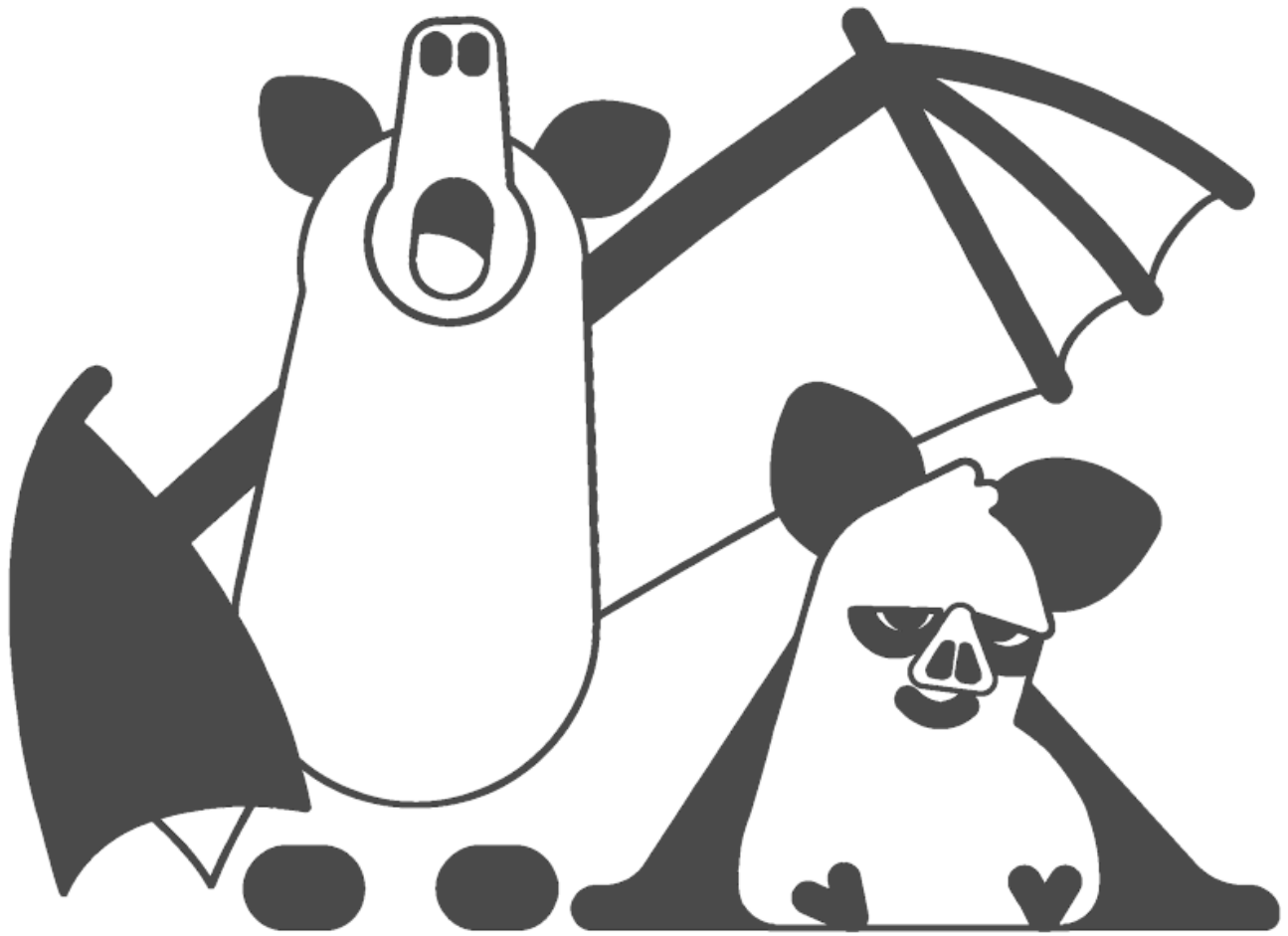

But all bats go to bed.

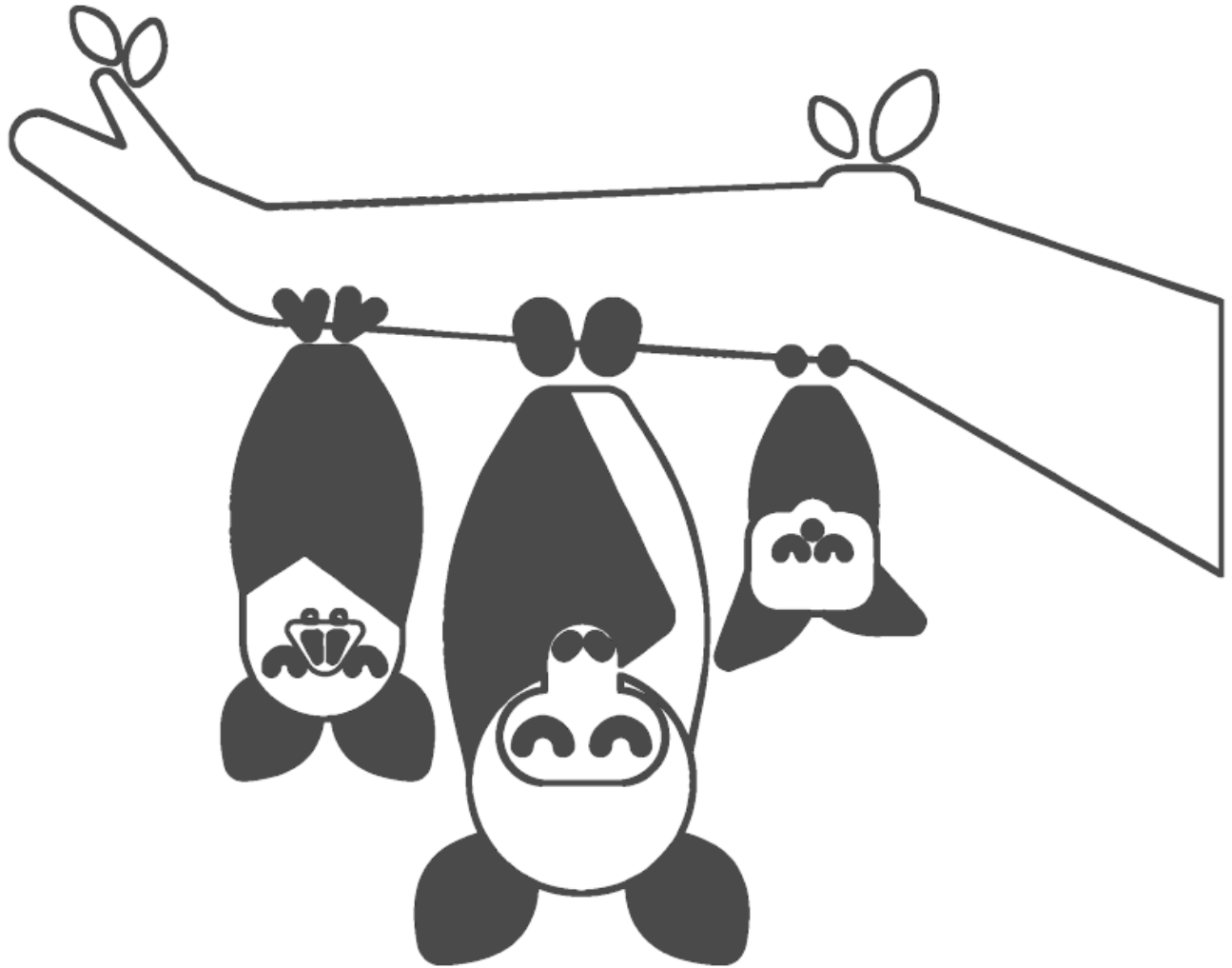

**Because bats sleep all
day!**

C c

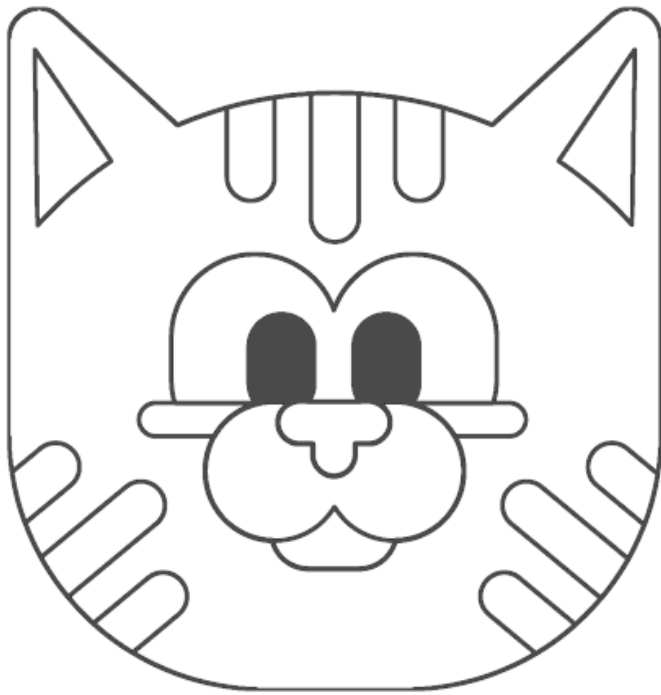

cat

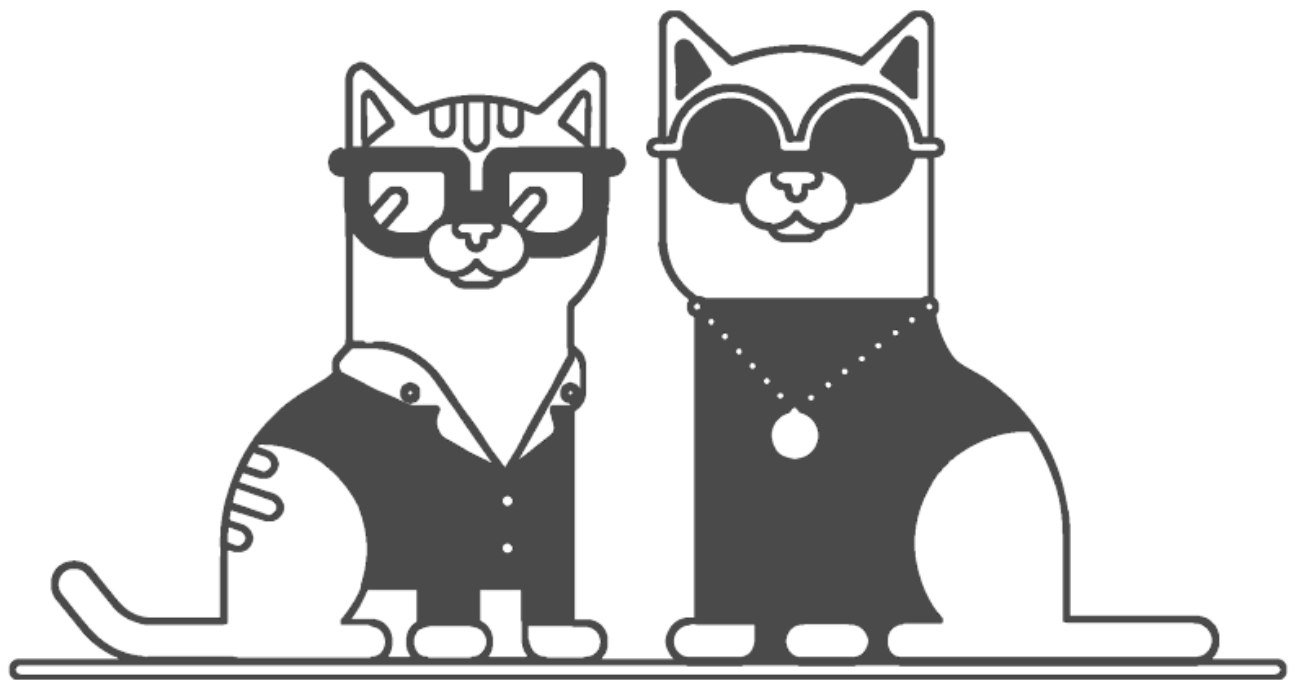

We are cool cats.

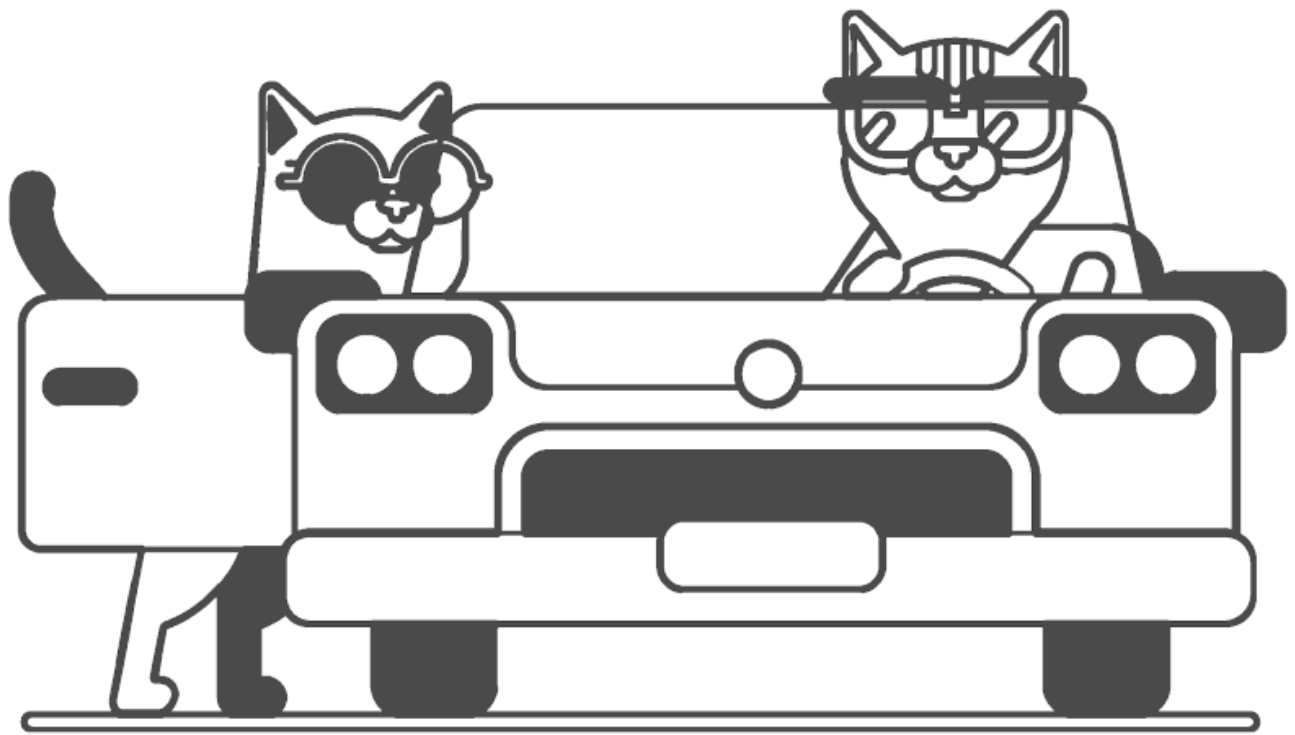

We go by car.

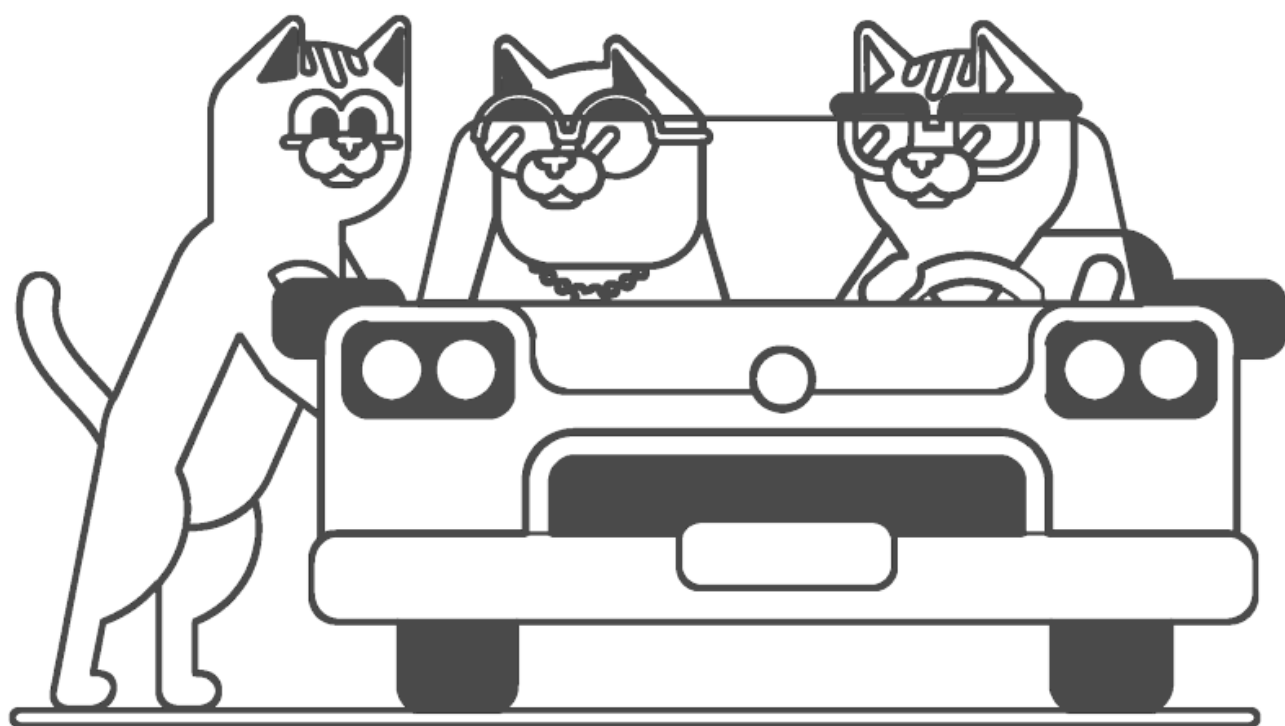

Can I come?

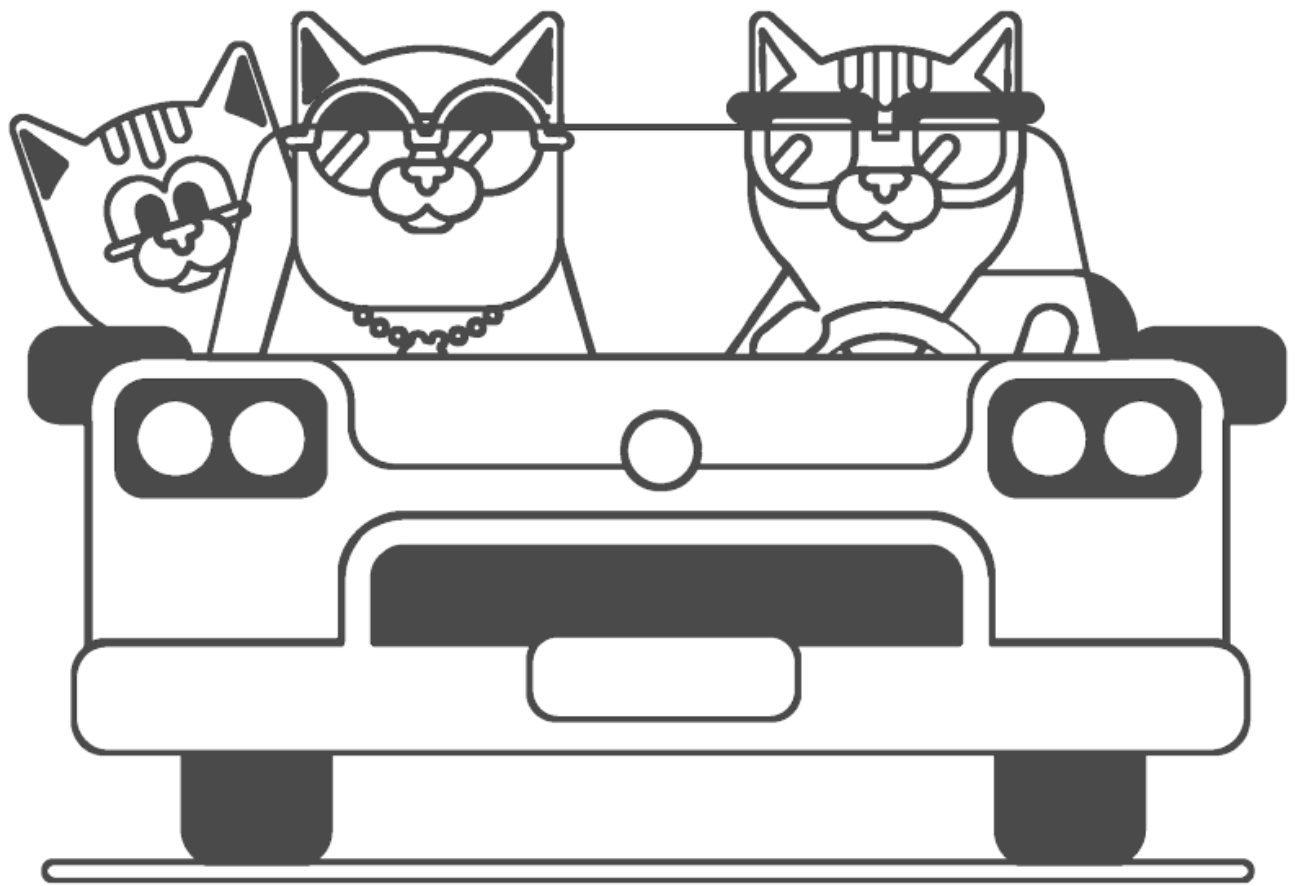

Yes, you can.

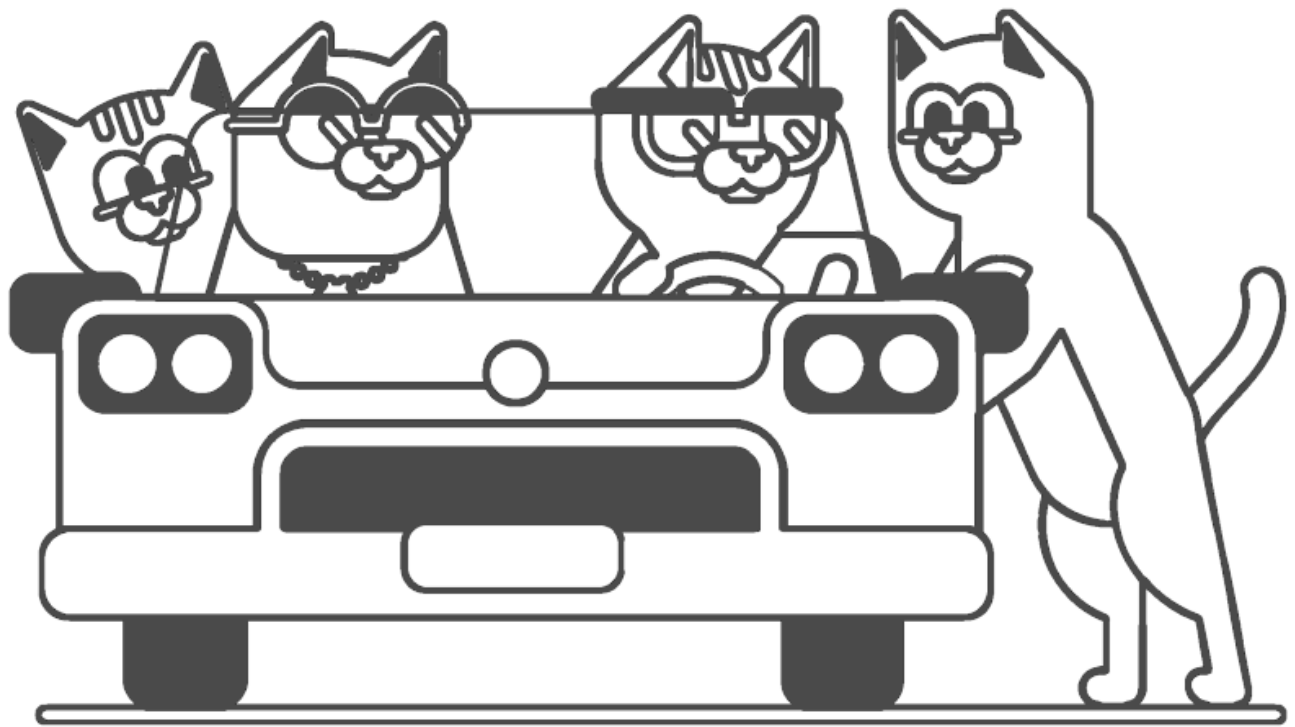

Can I come?

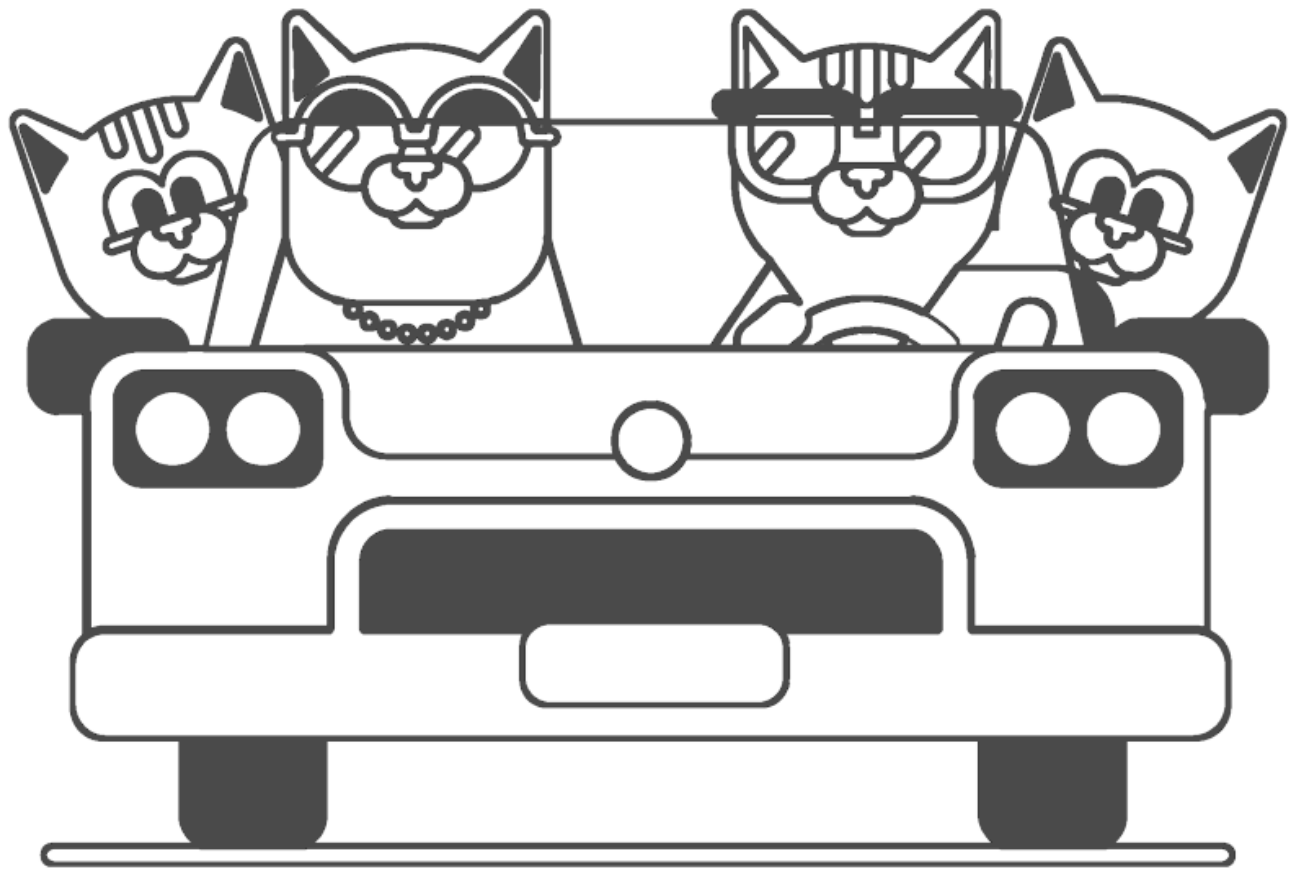

Yes, you can.

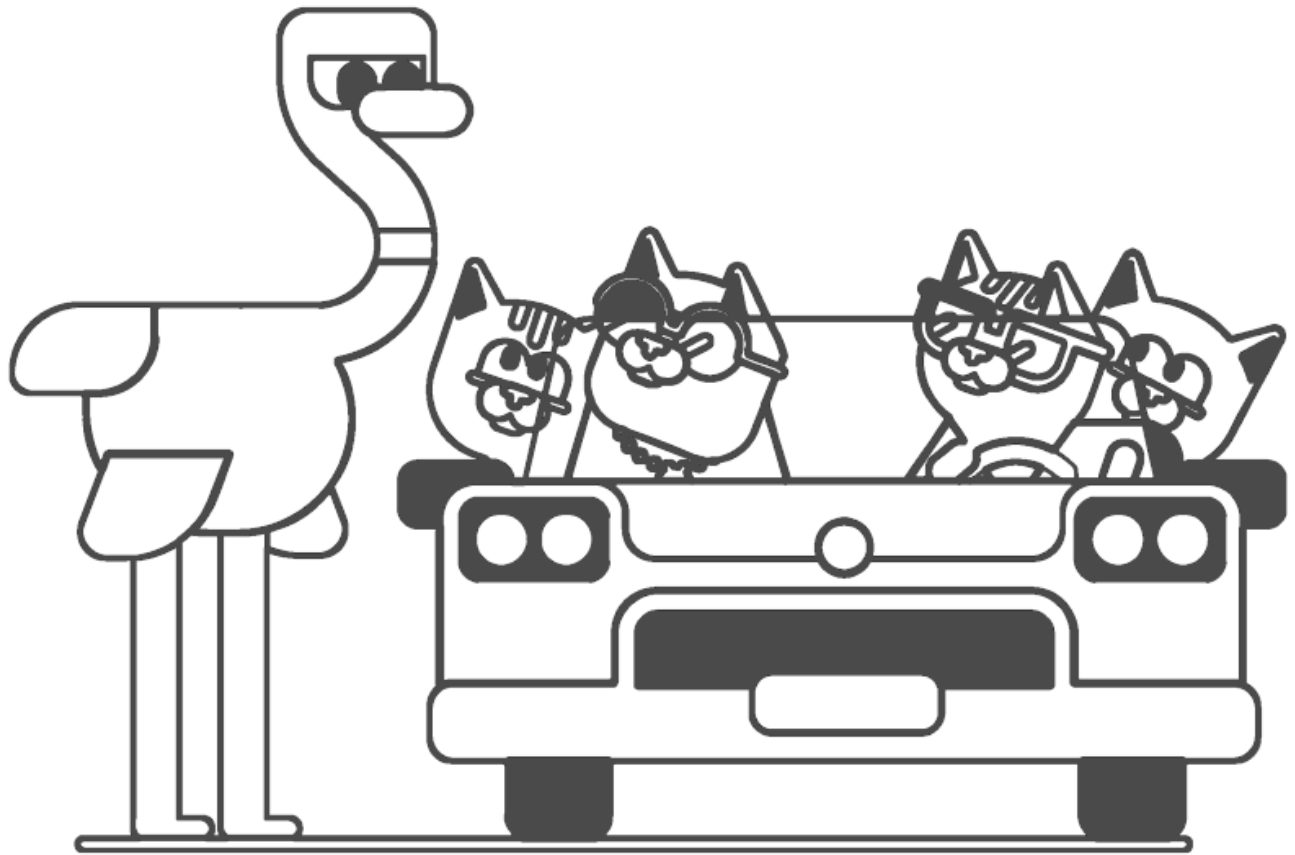

Can I come too?

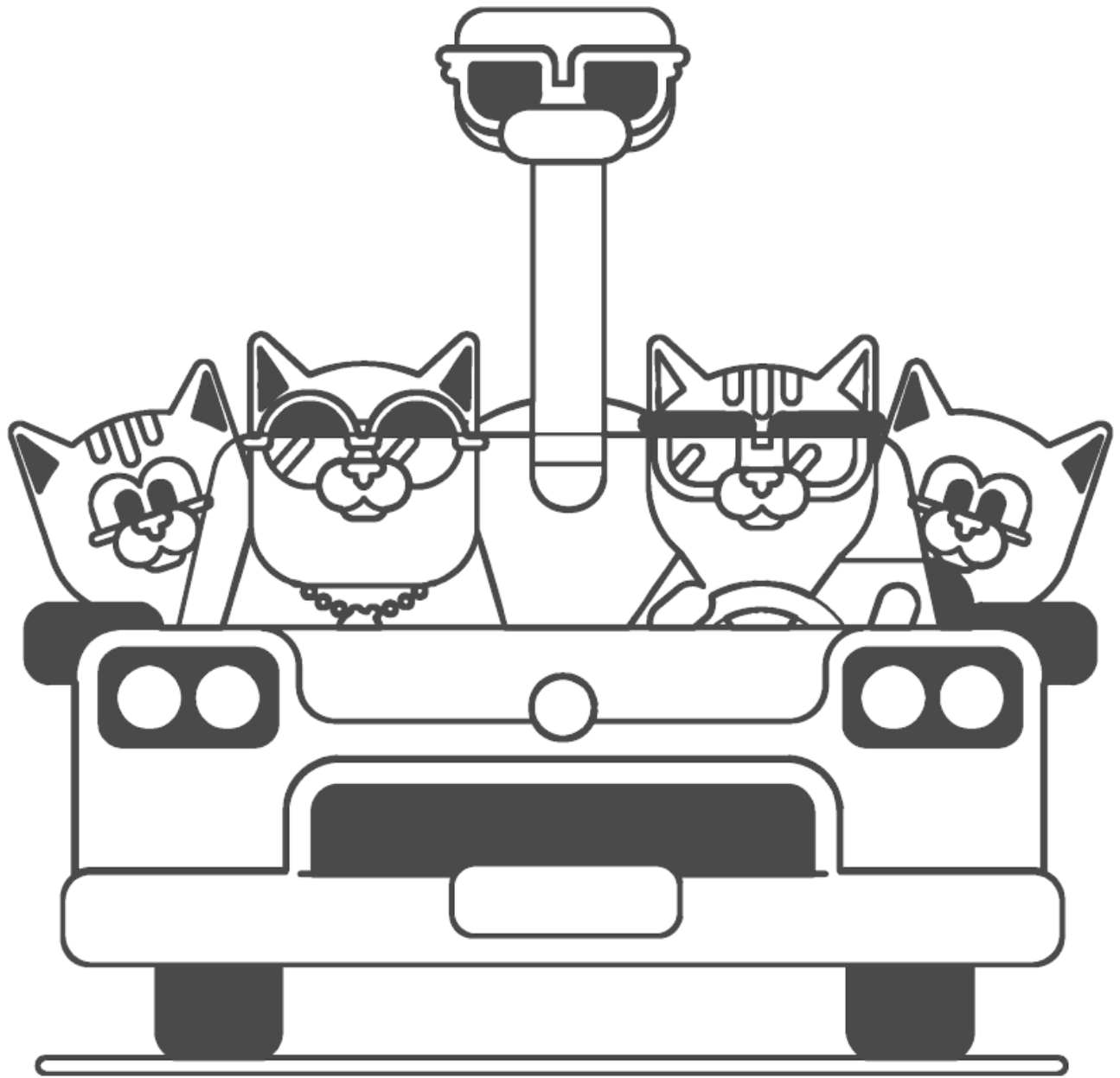

Yes, you can come too!

D d

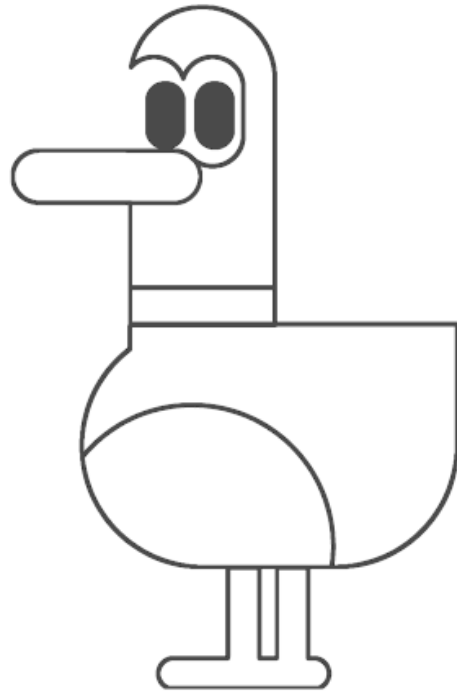

duck

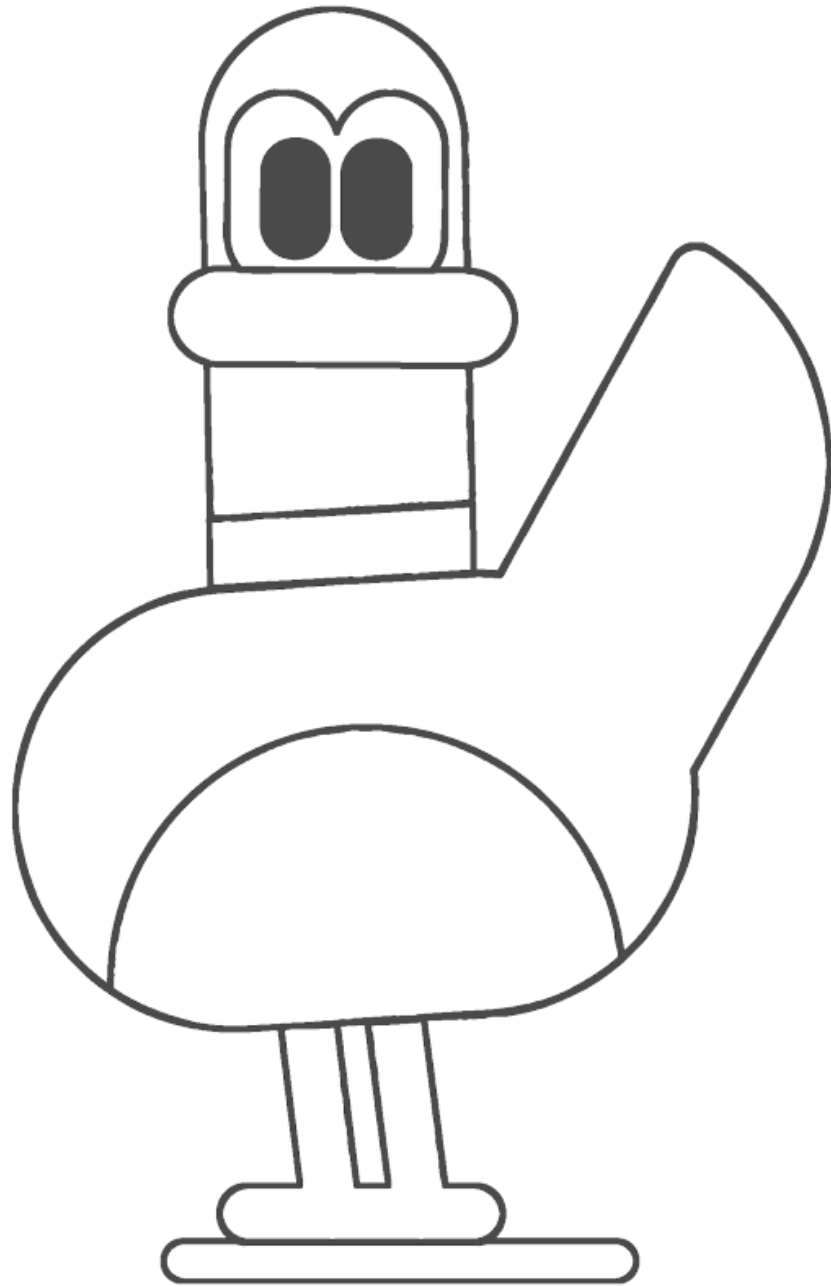

Dex is a duck.

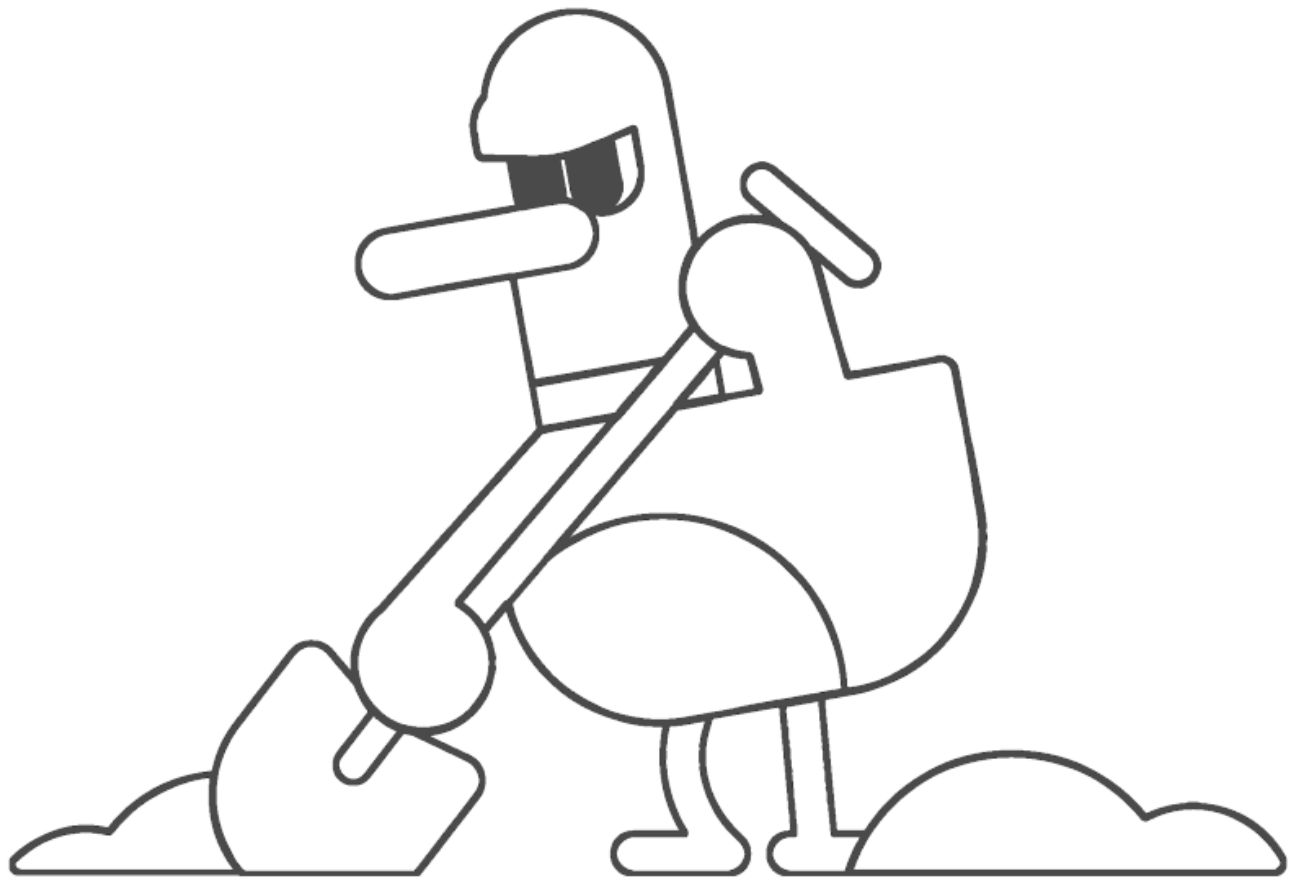

Dex can dig.

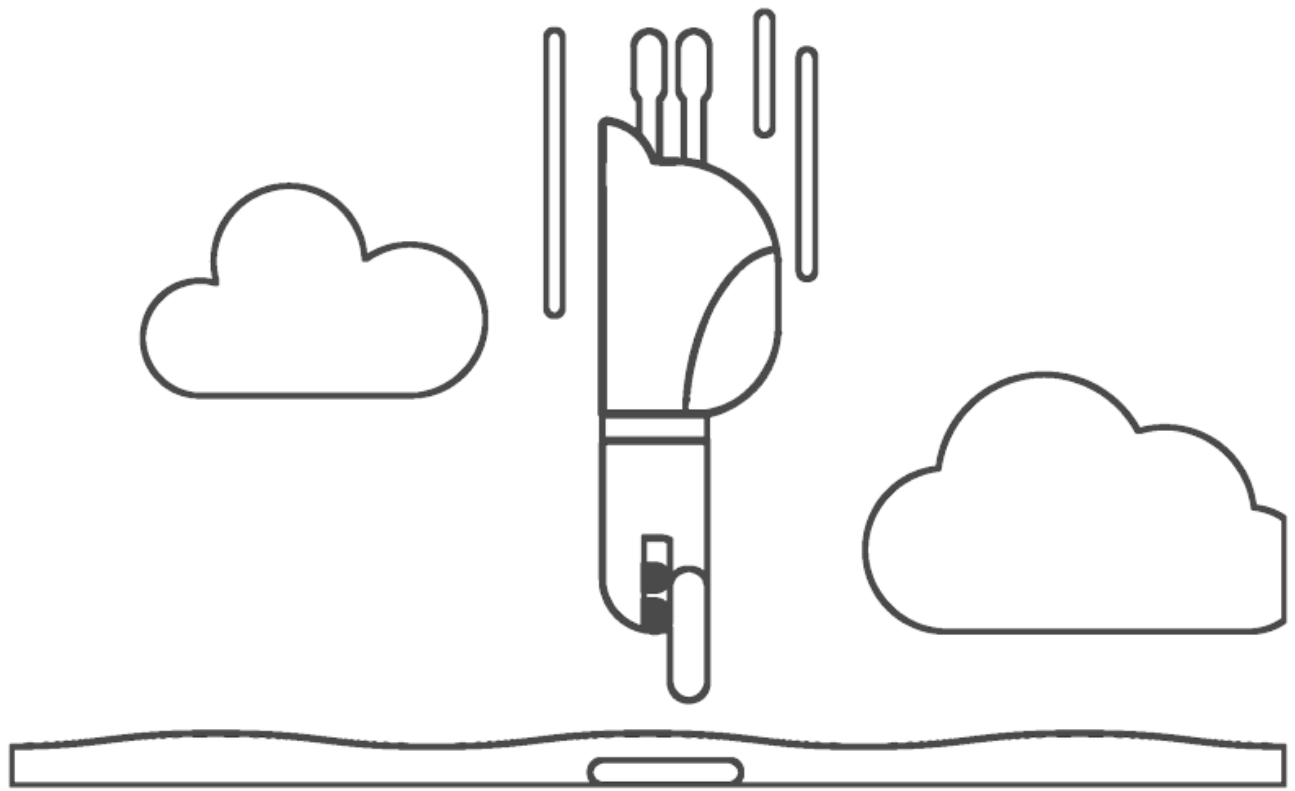

Dex can dive.

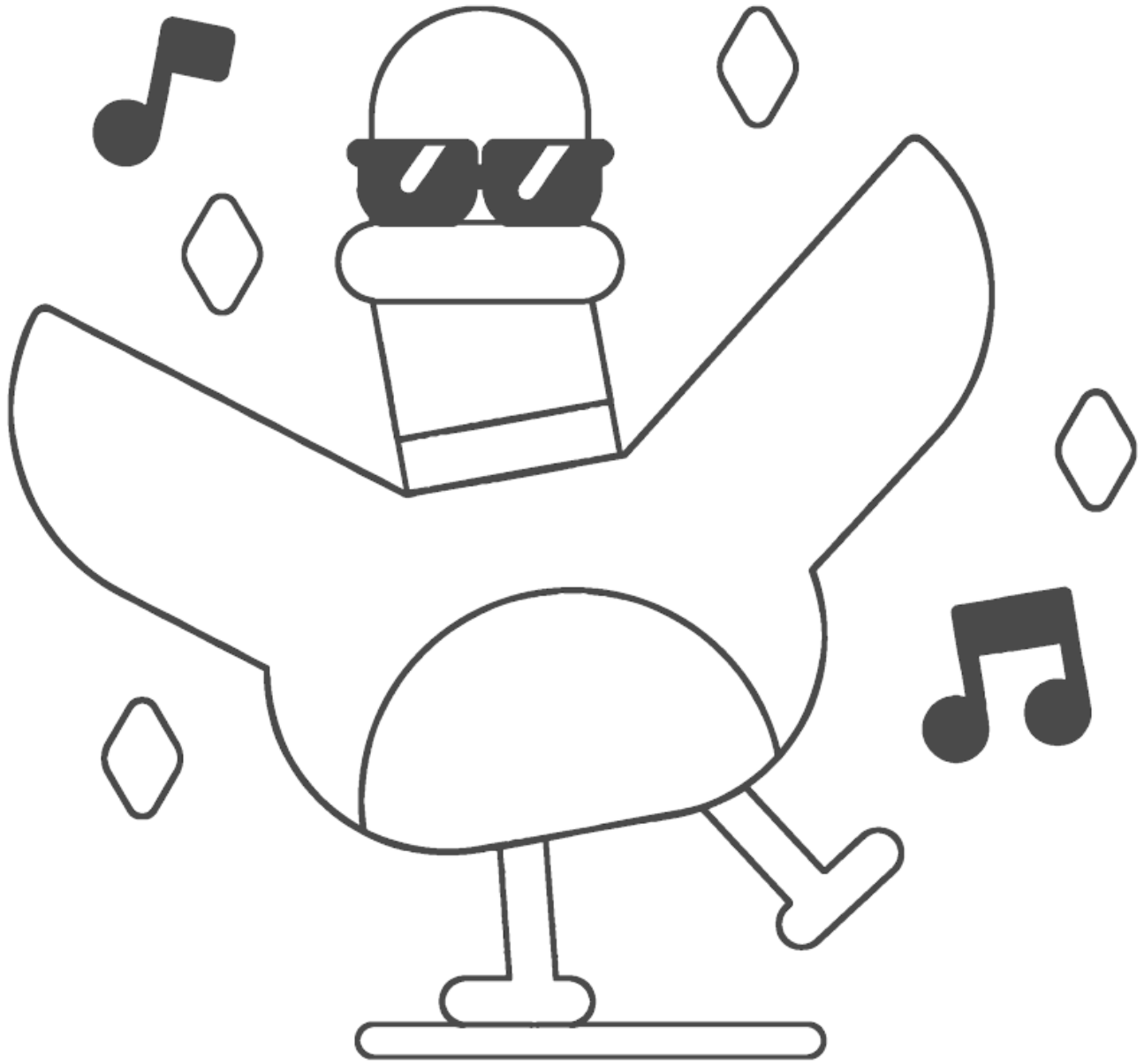

Dex can dance.

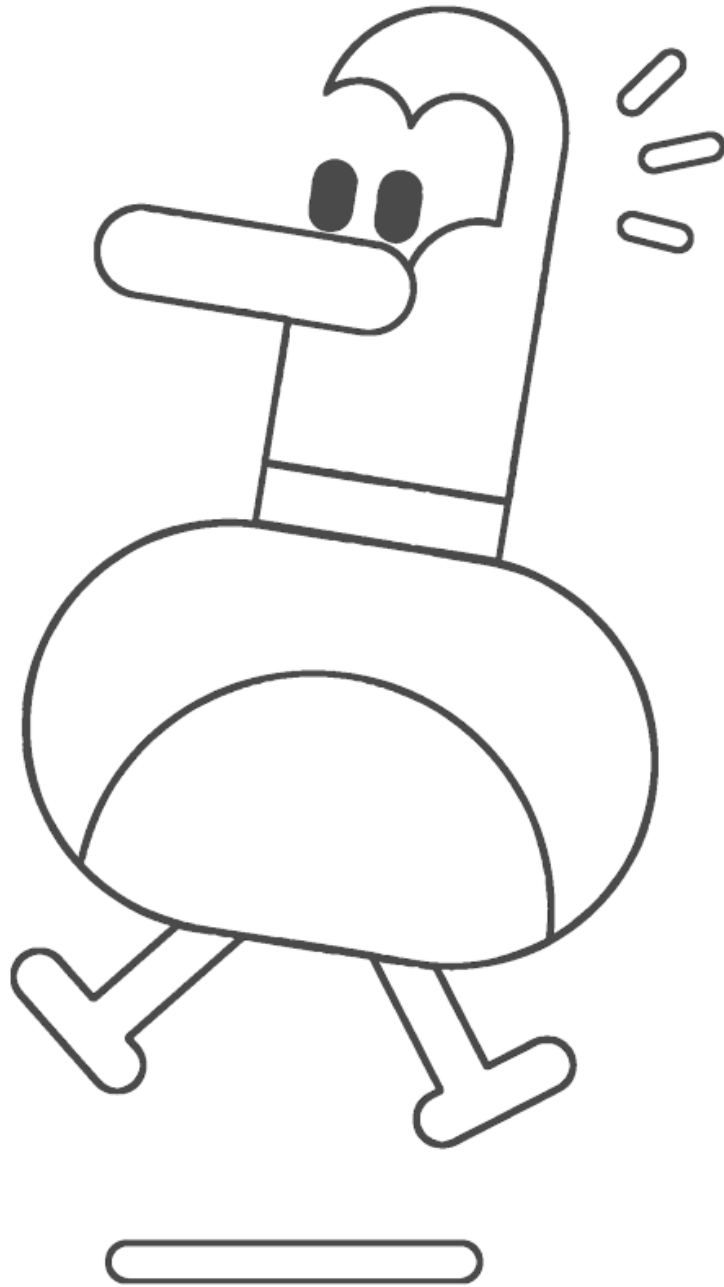

Look out, Dex!

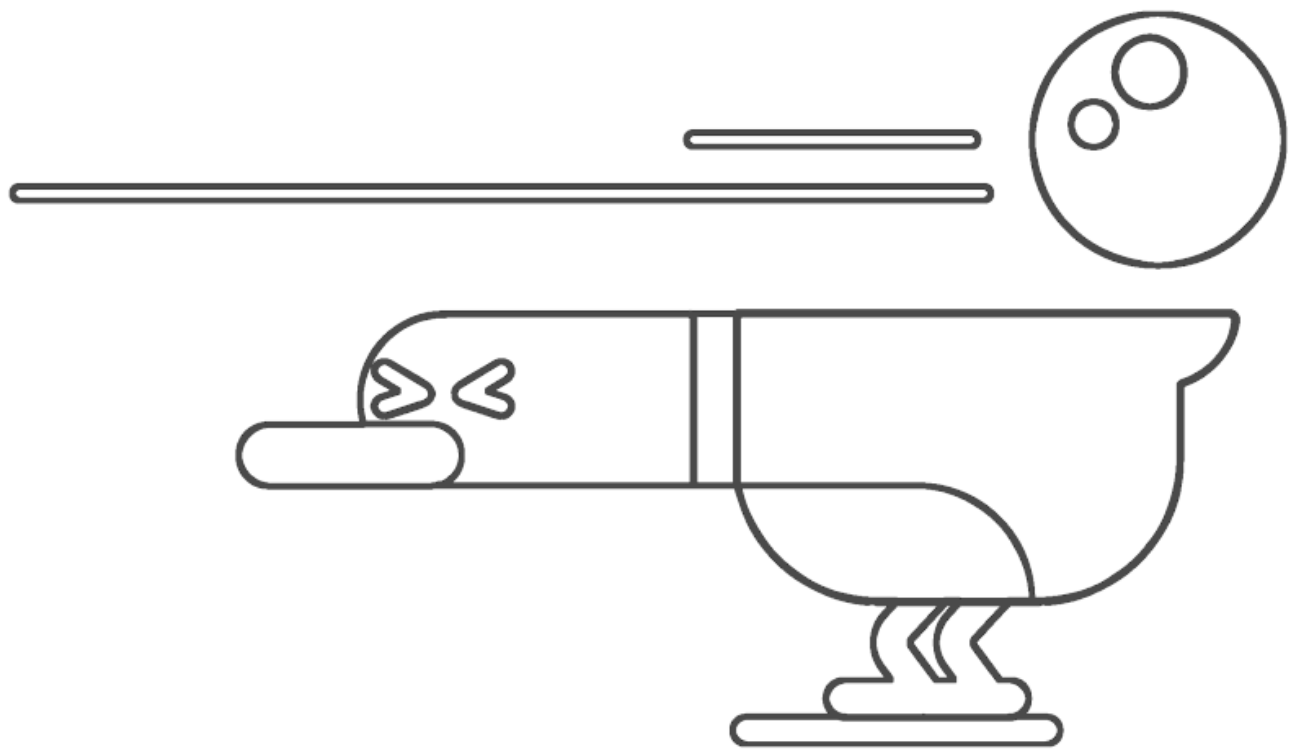

Dex can duck!

E e

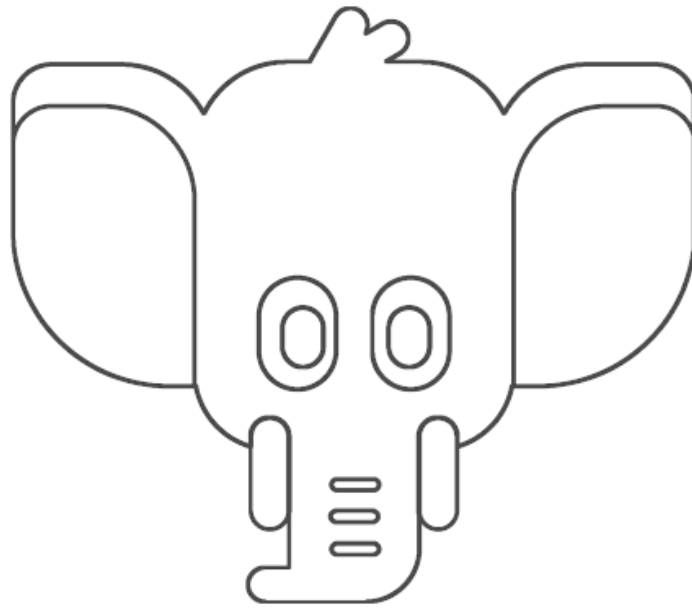

elephant

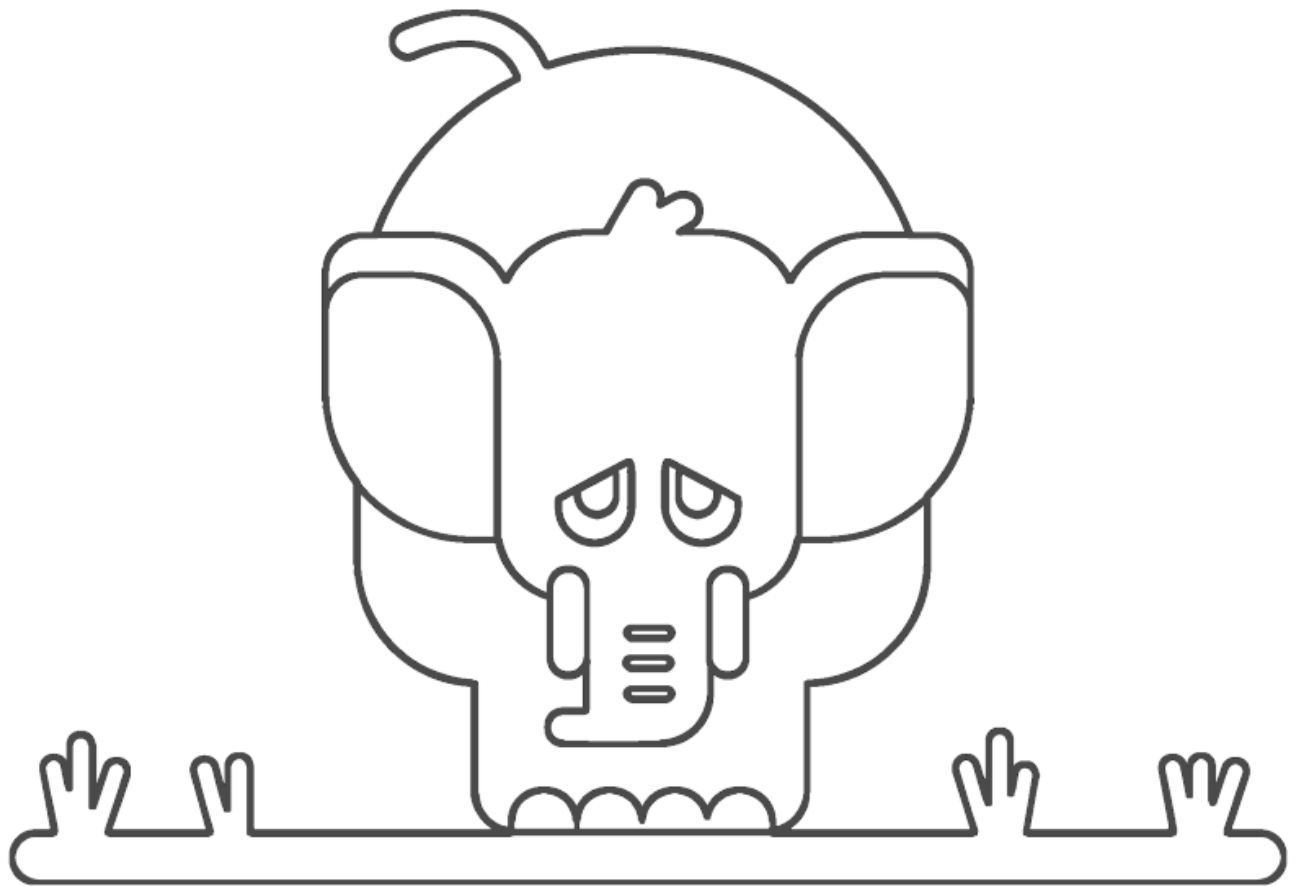

Do you ever feel tall?

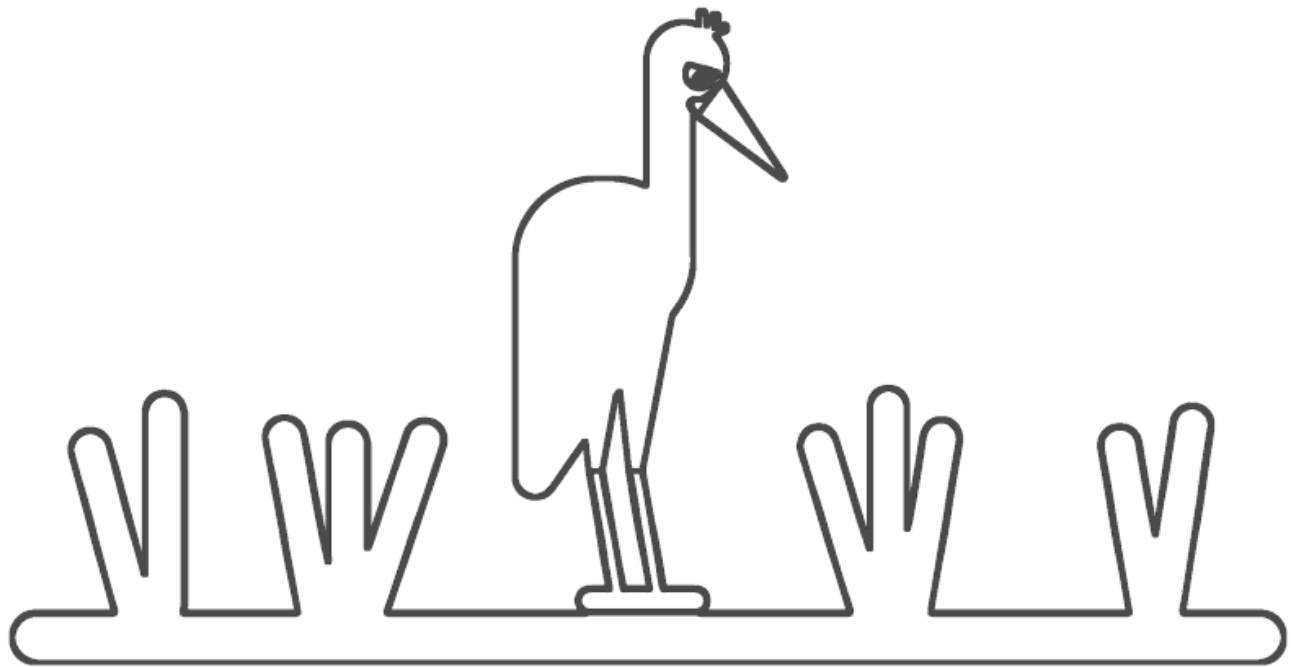

Do you ever feel small?

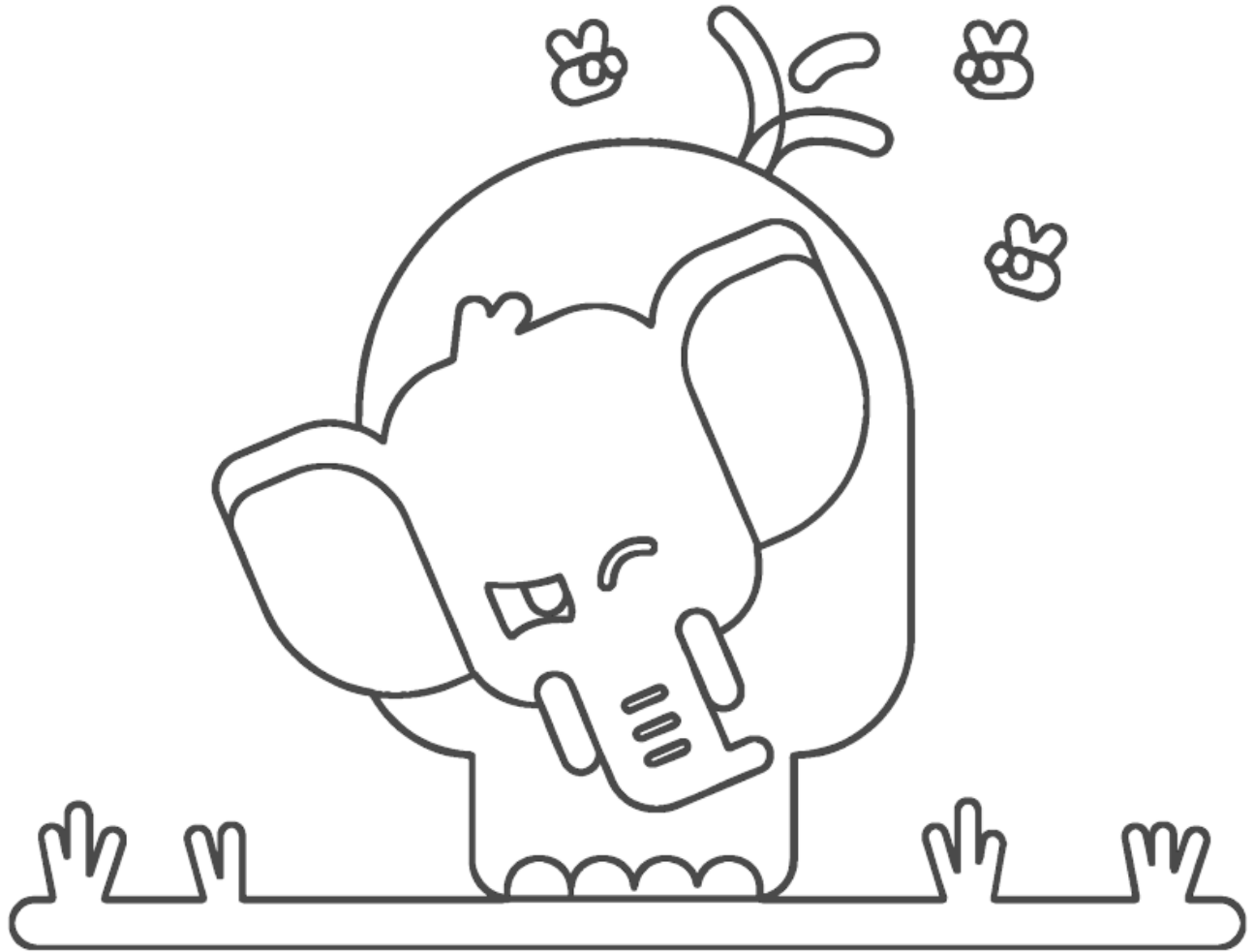

Do you ever feel mad?

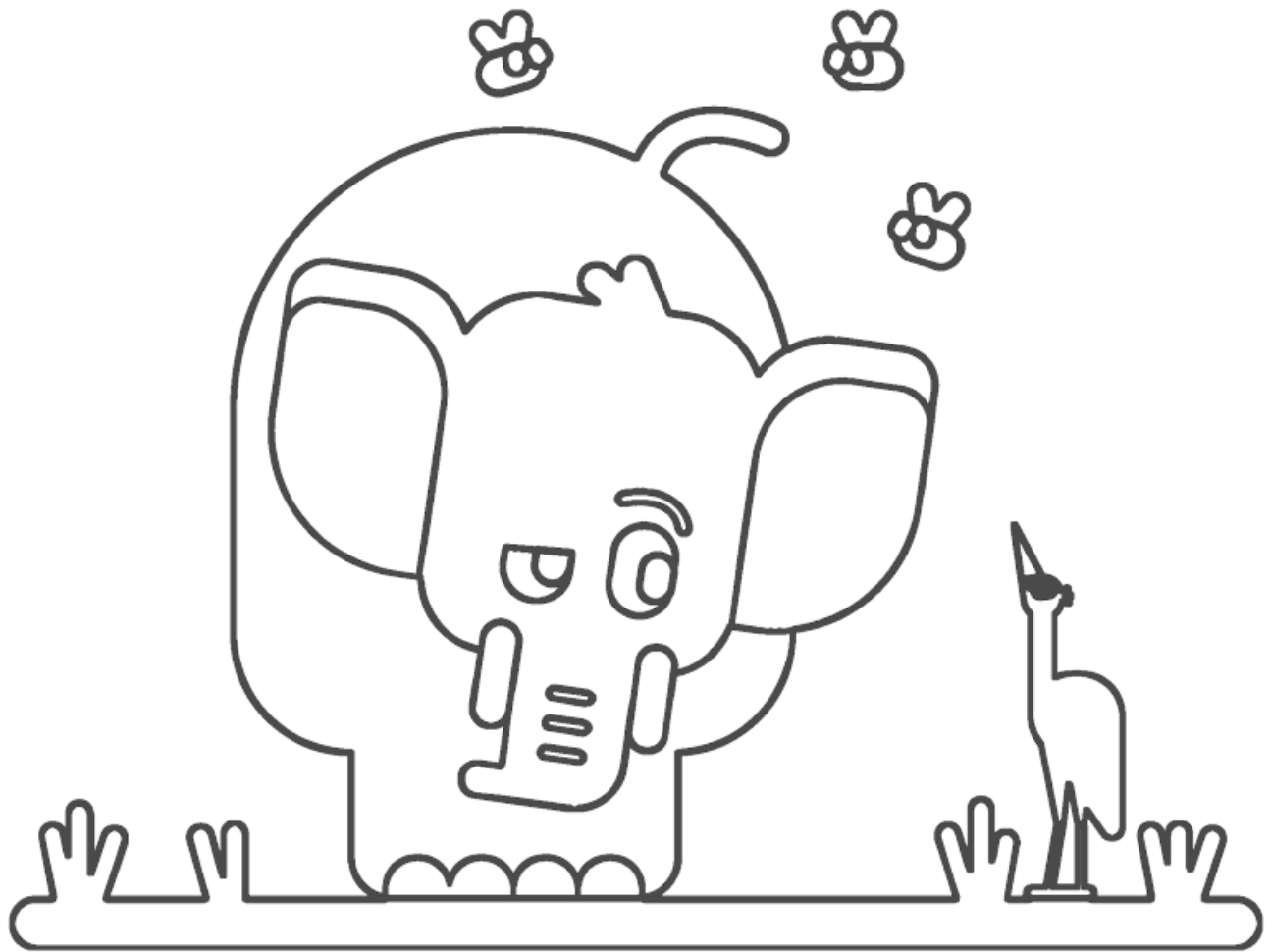

Do you ever feel glad?

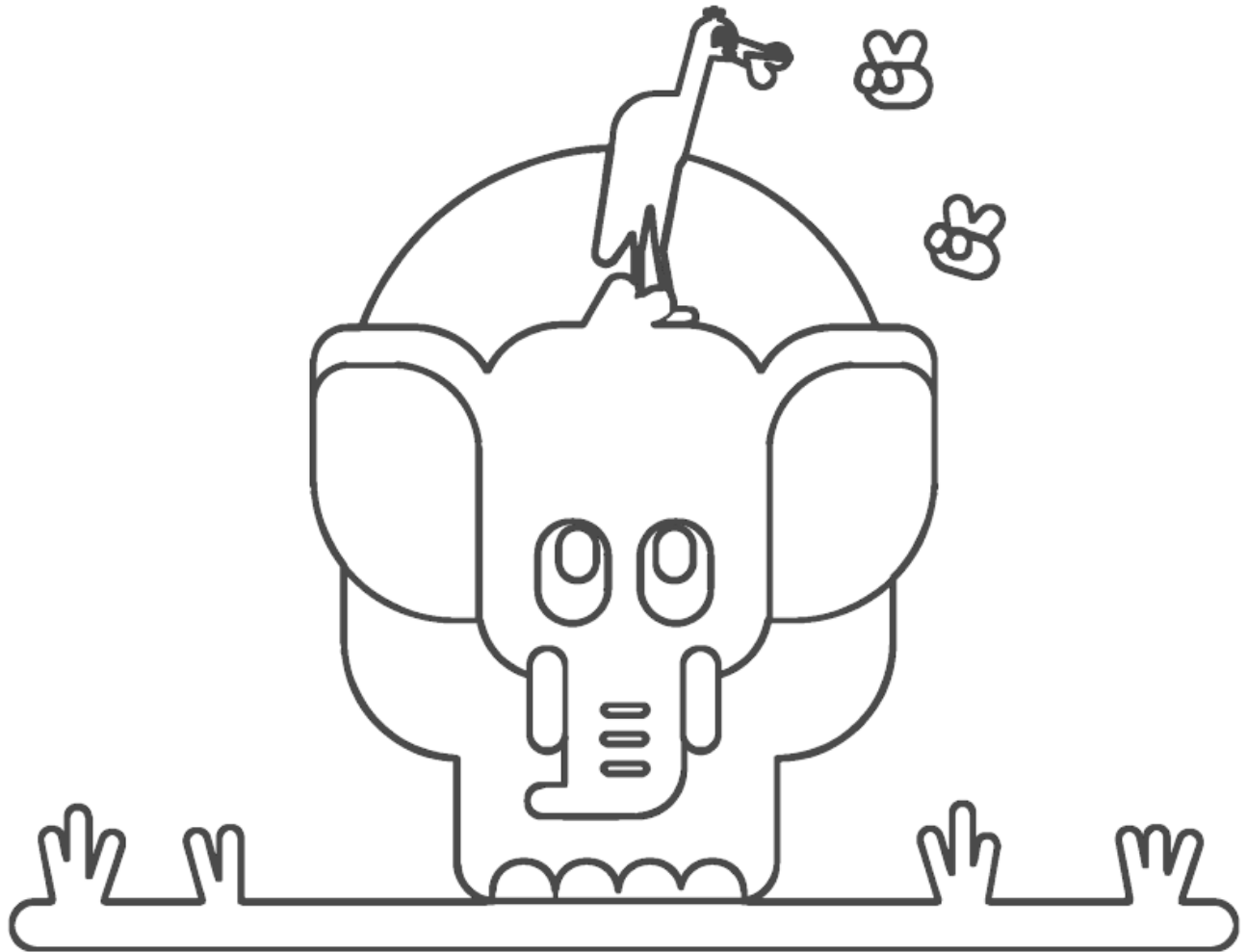

**Do you ever feel
complete?**

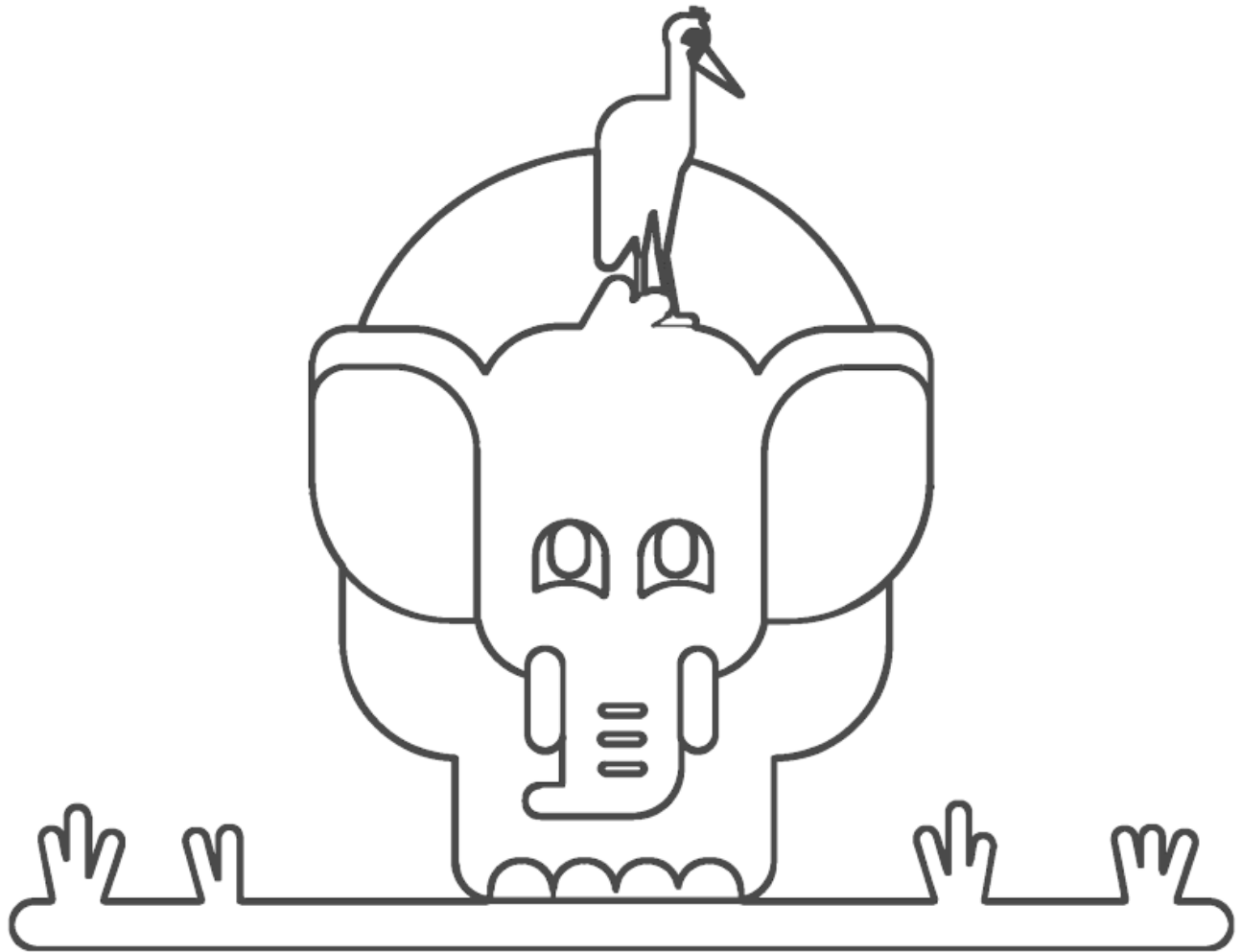

Every time we meet!

F f

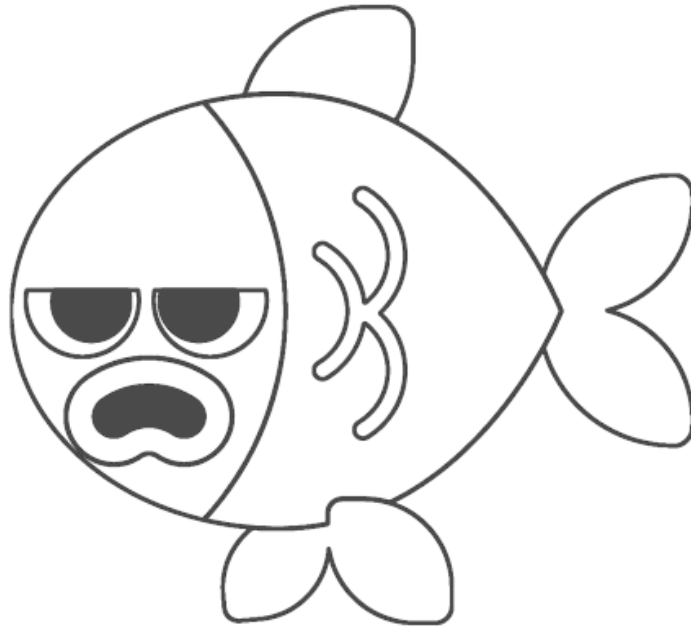

fish

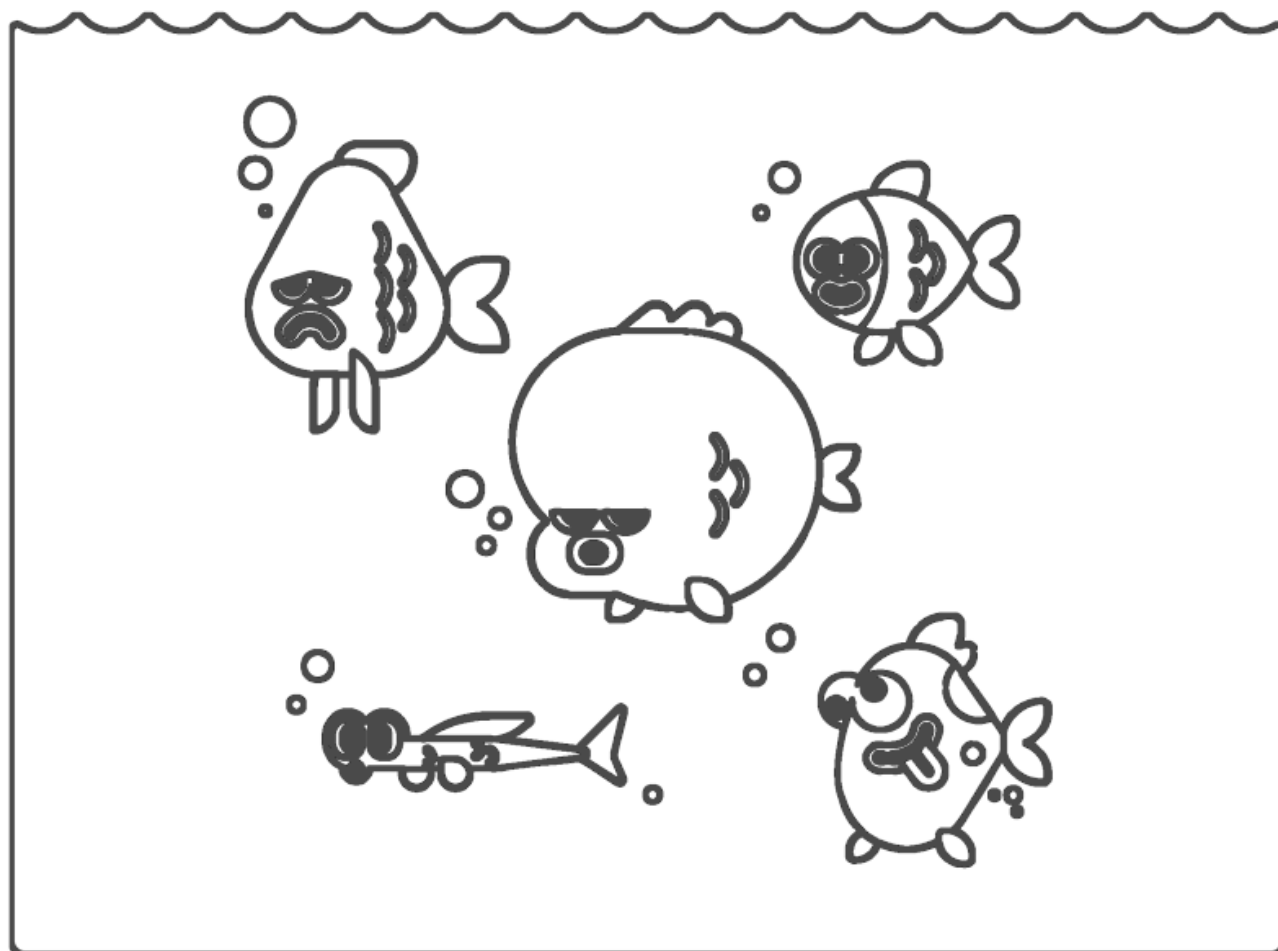

I see five fish.

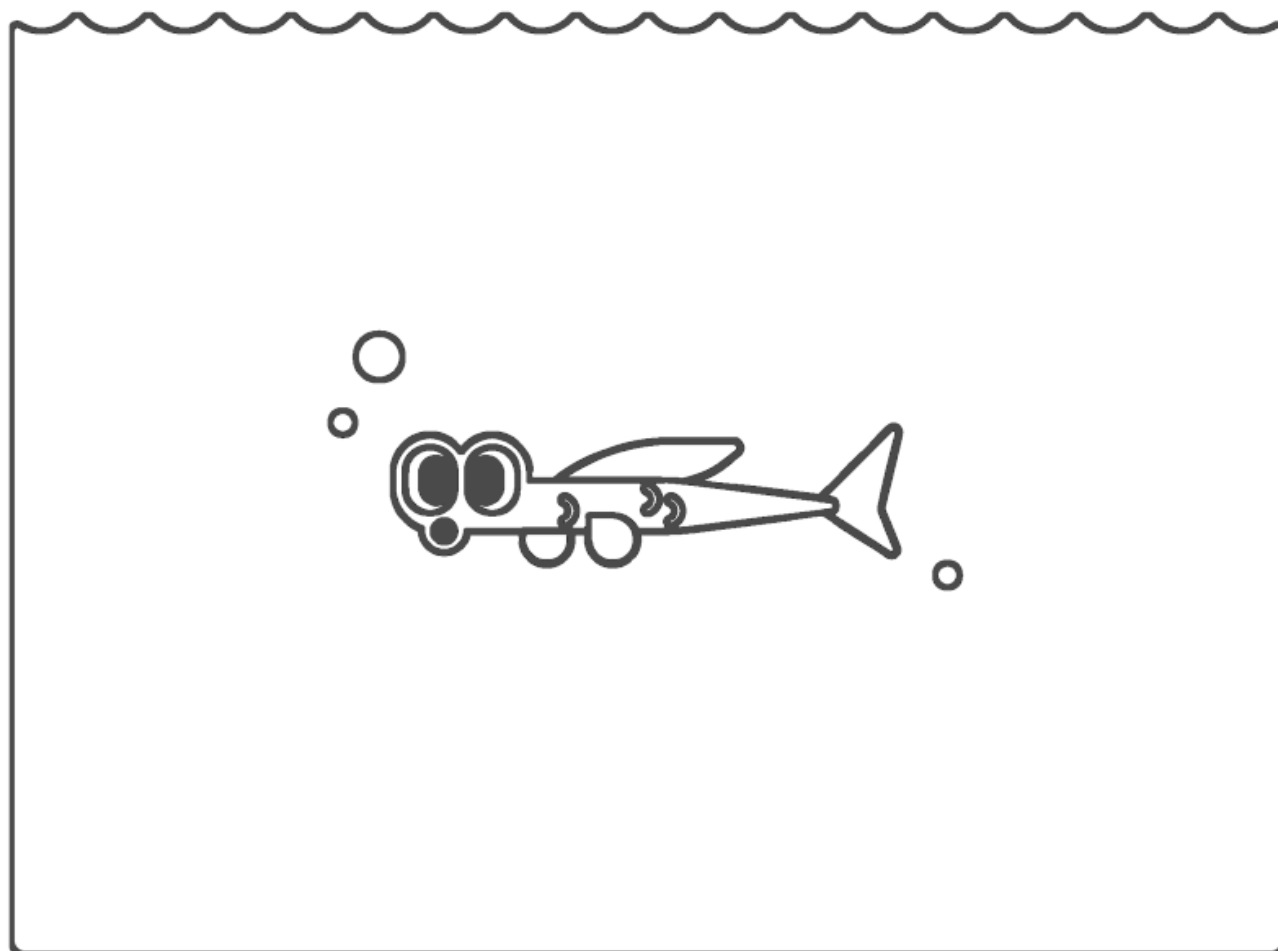

A skinny fish.



A fat fish.

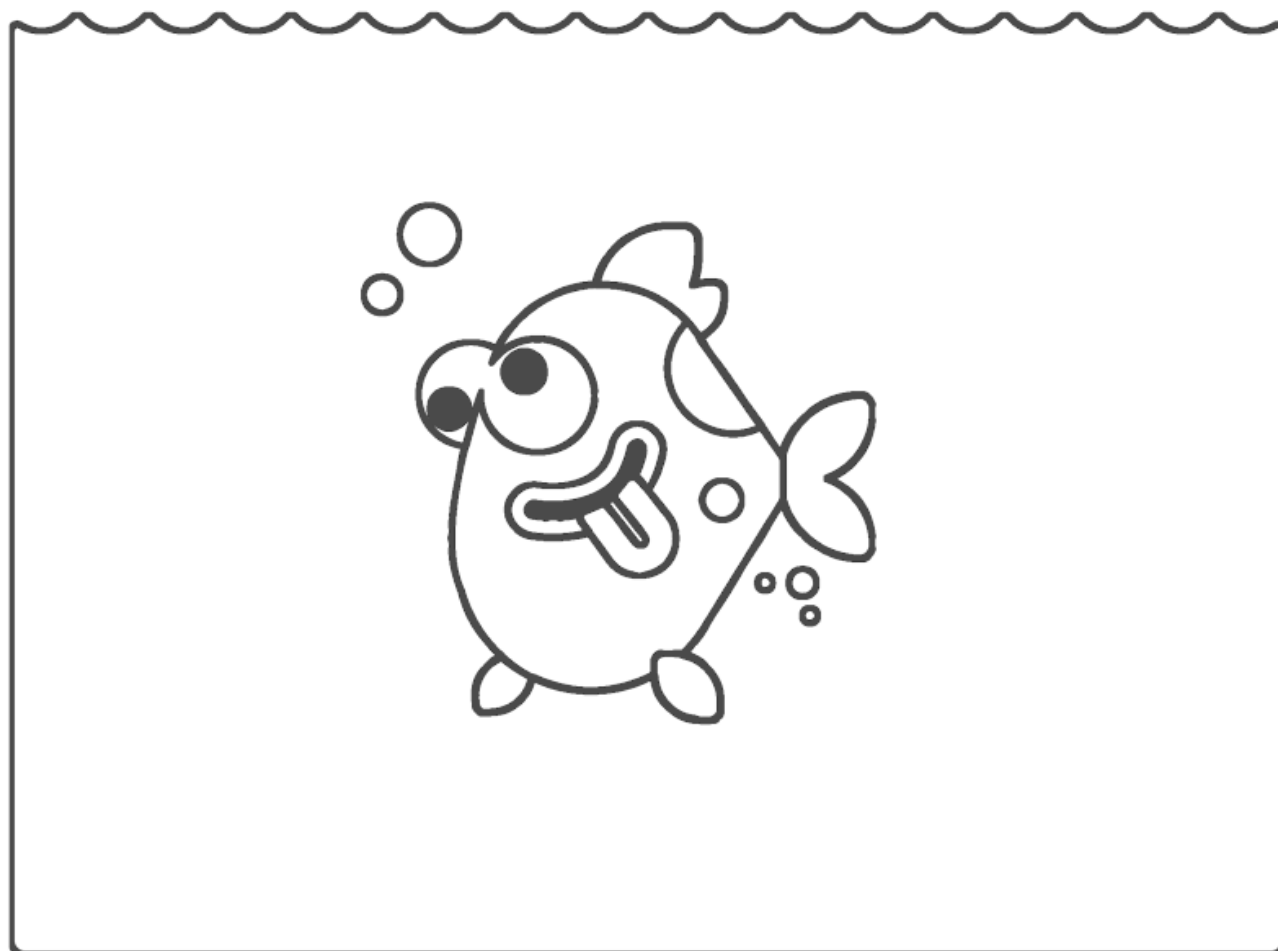

A funny fish.

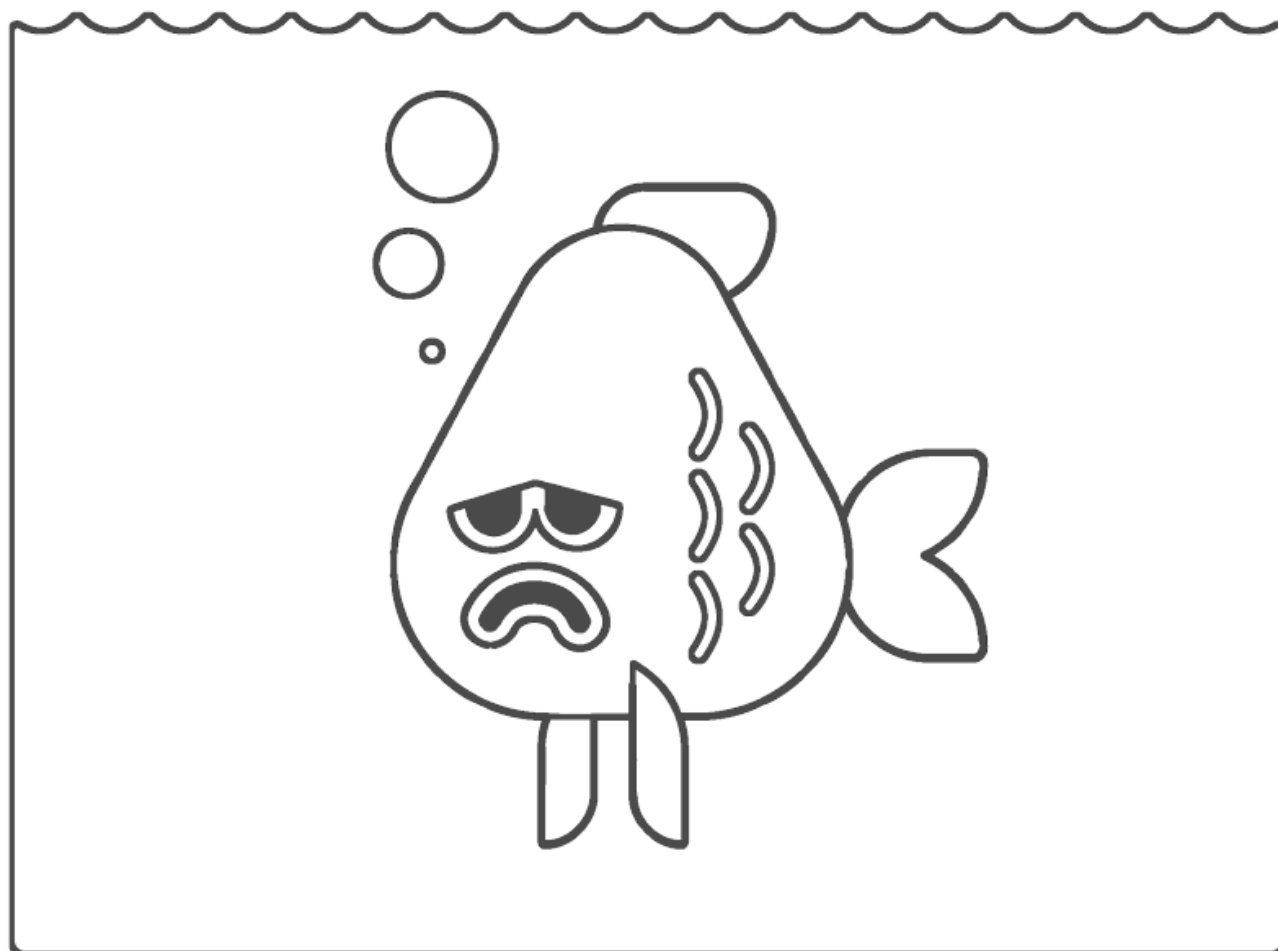

A sad fish.

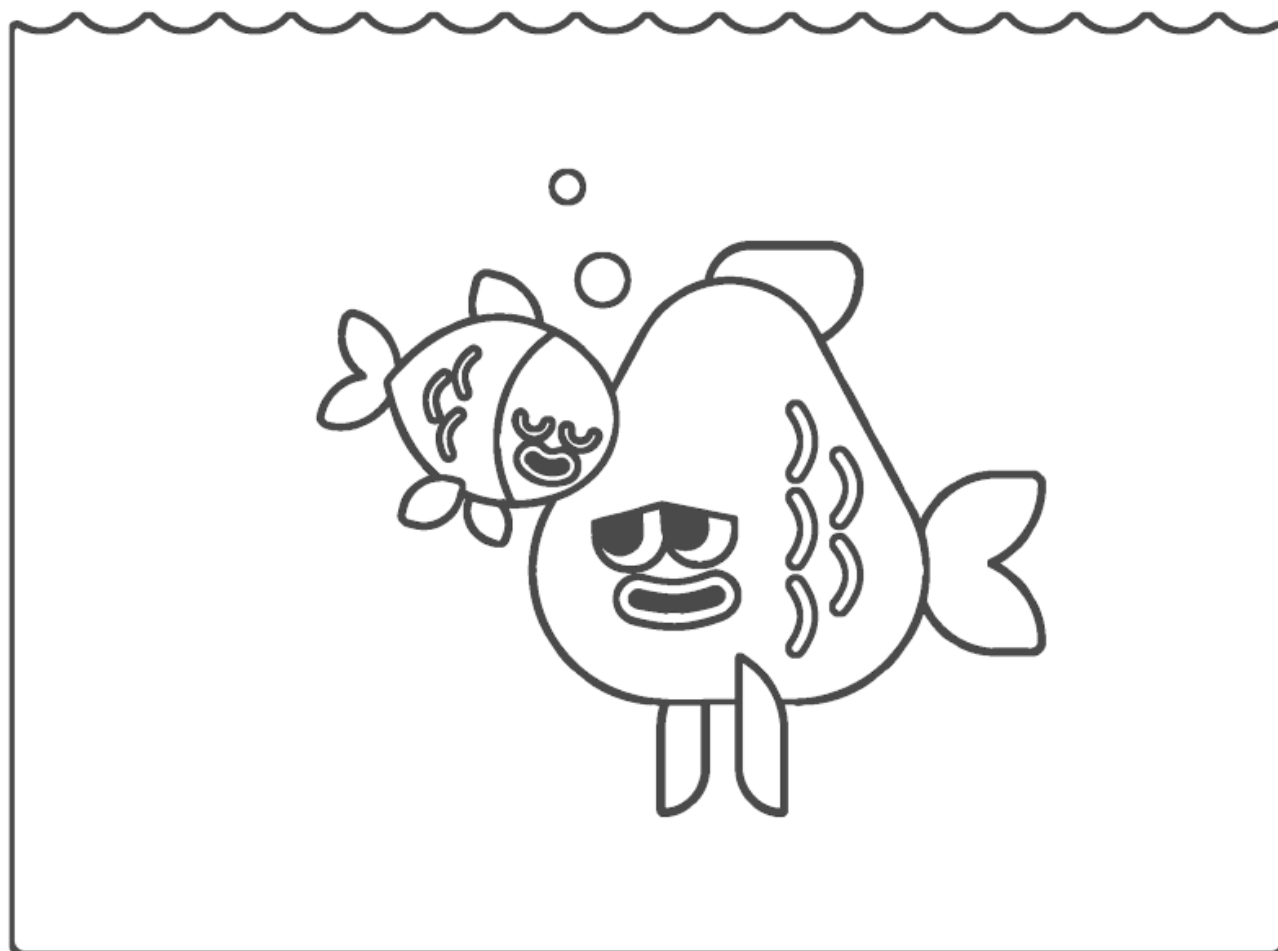

And a very nice fish.

G g

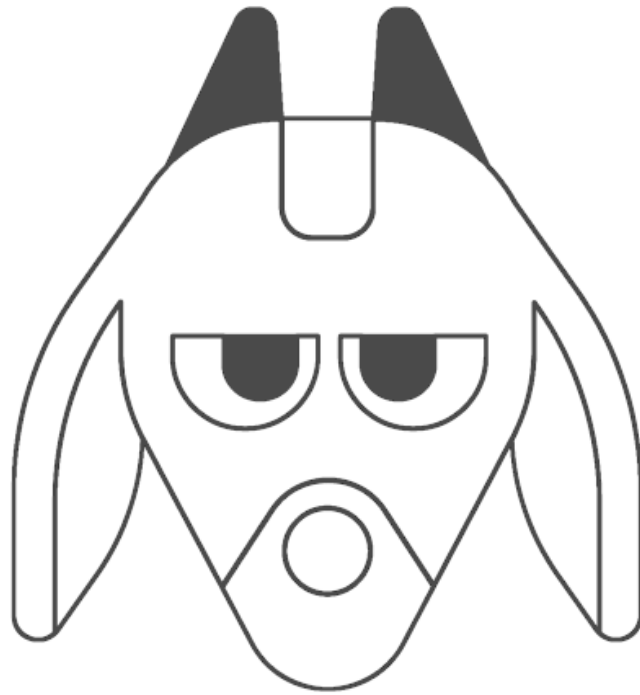

goat

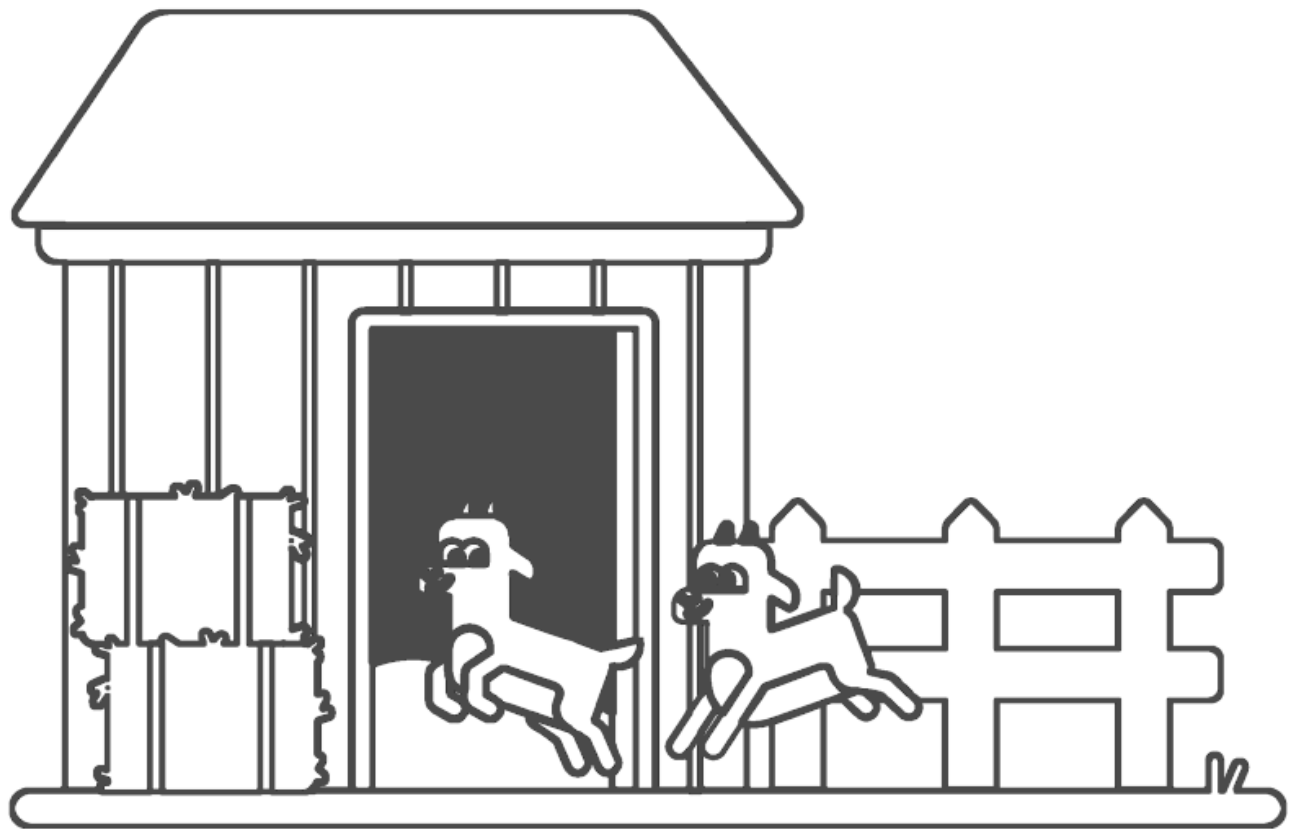

The goats go in.

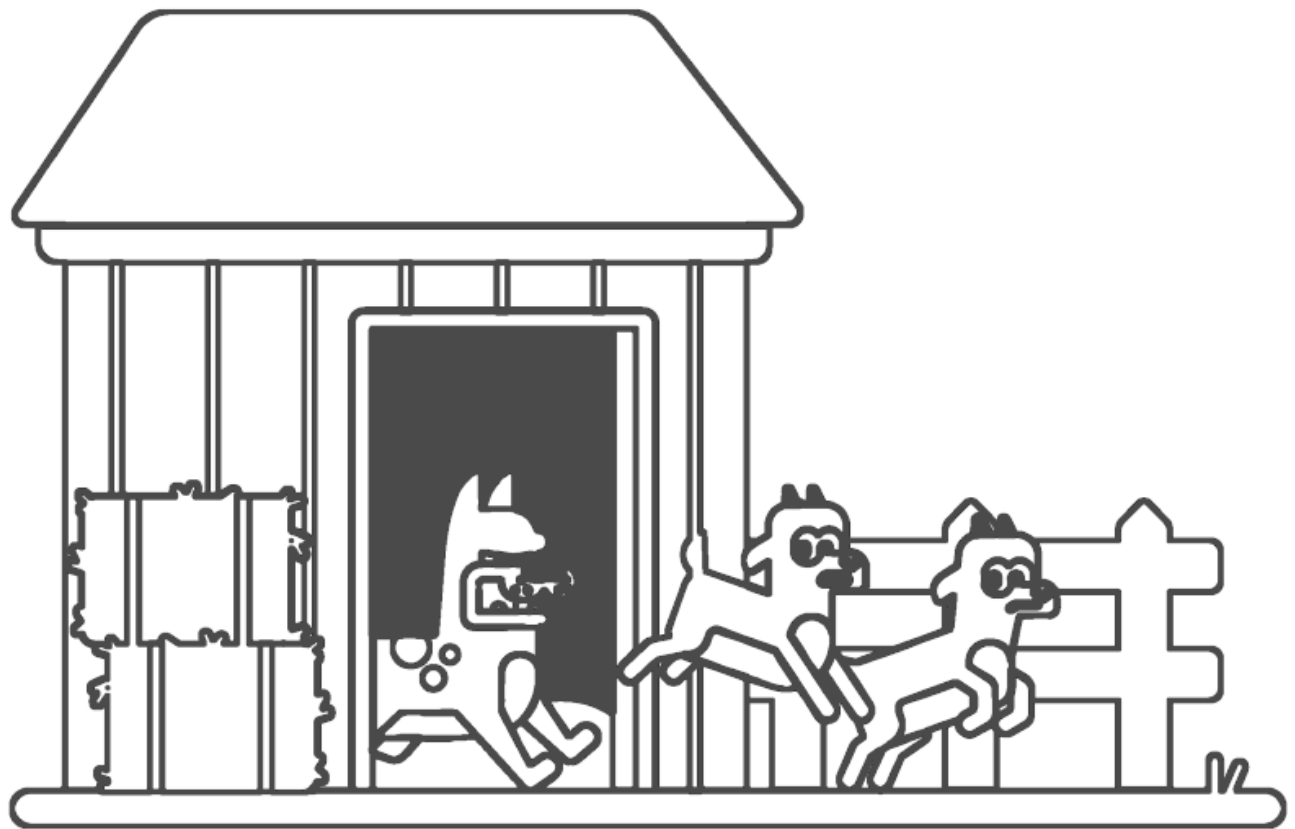

The goats go out.

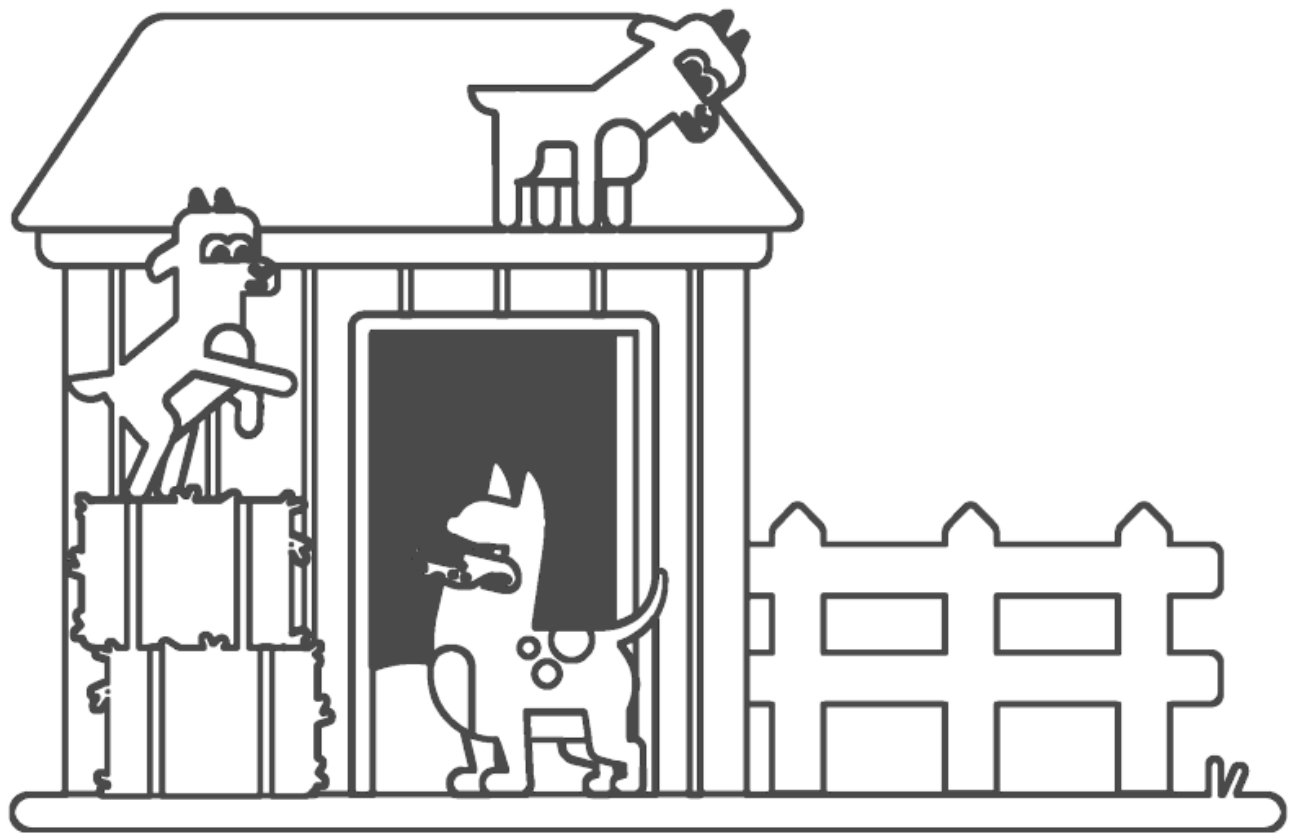

The goats go up.

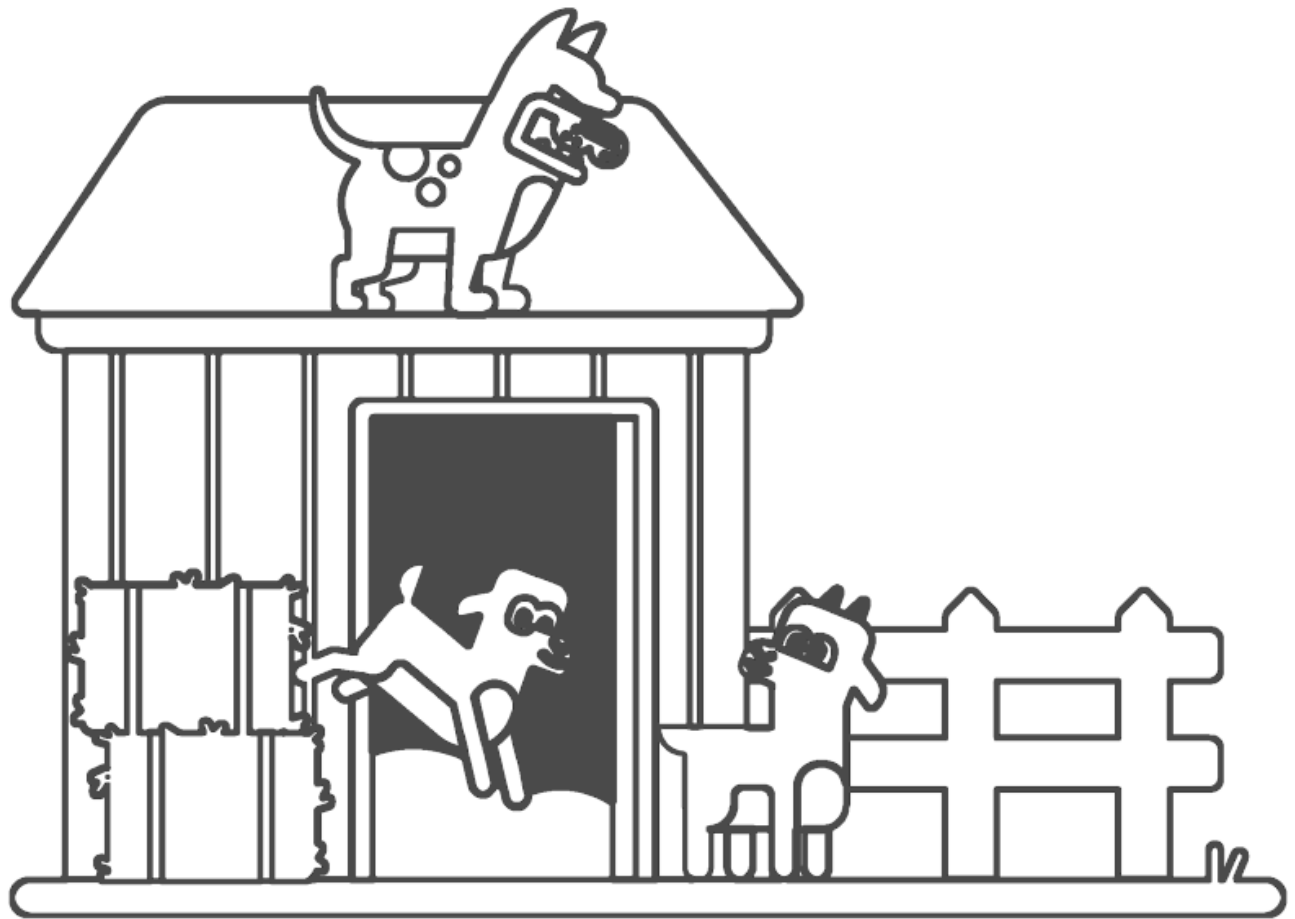

The goats go down.

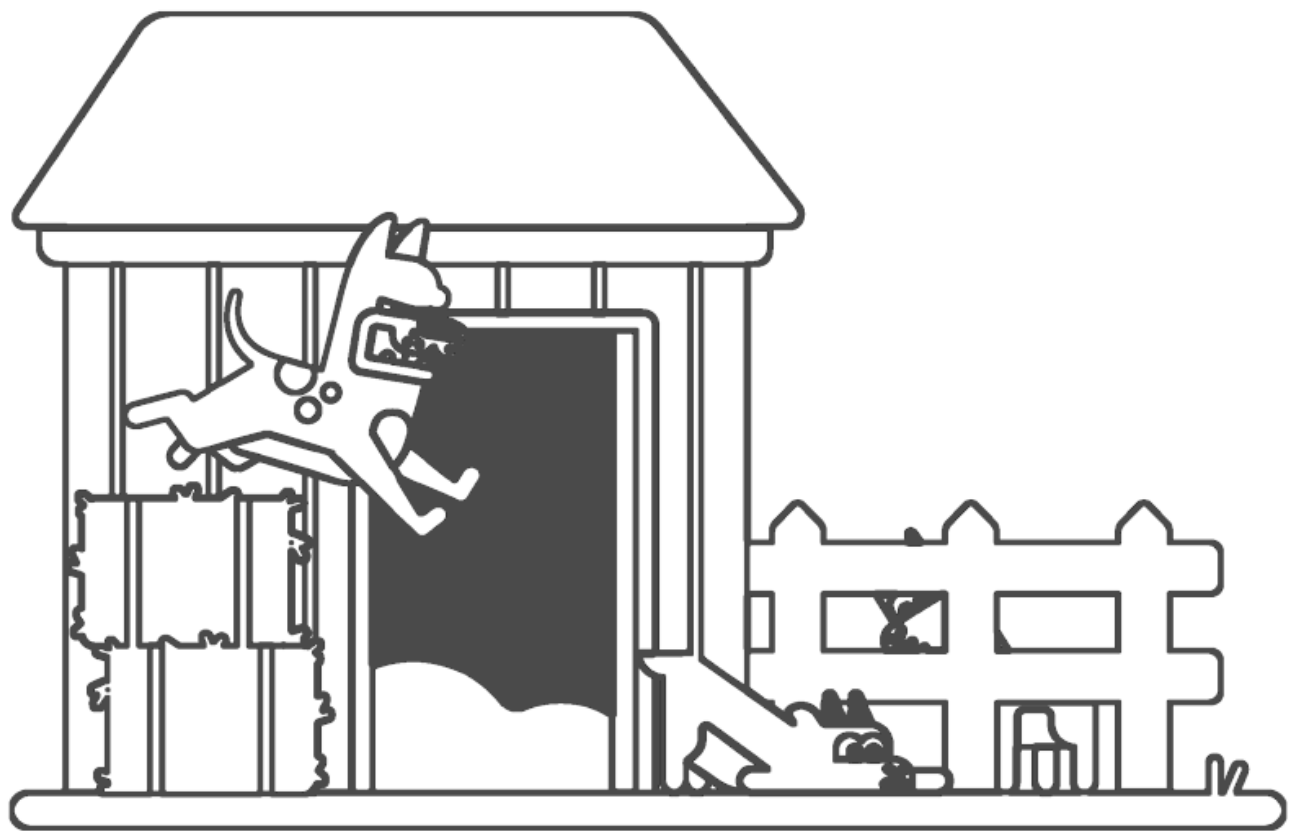

The goats go under.

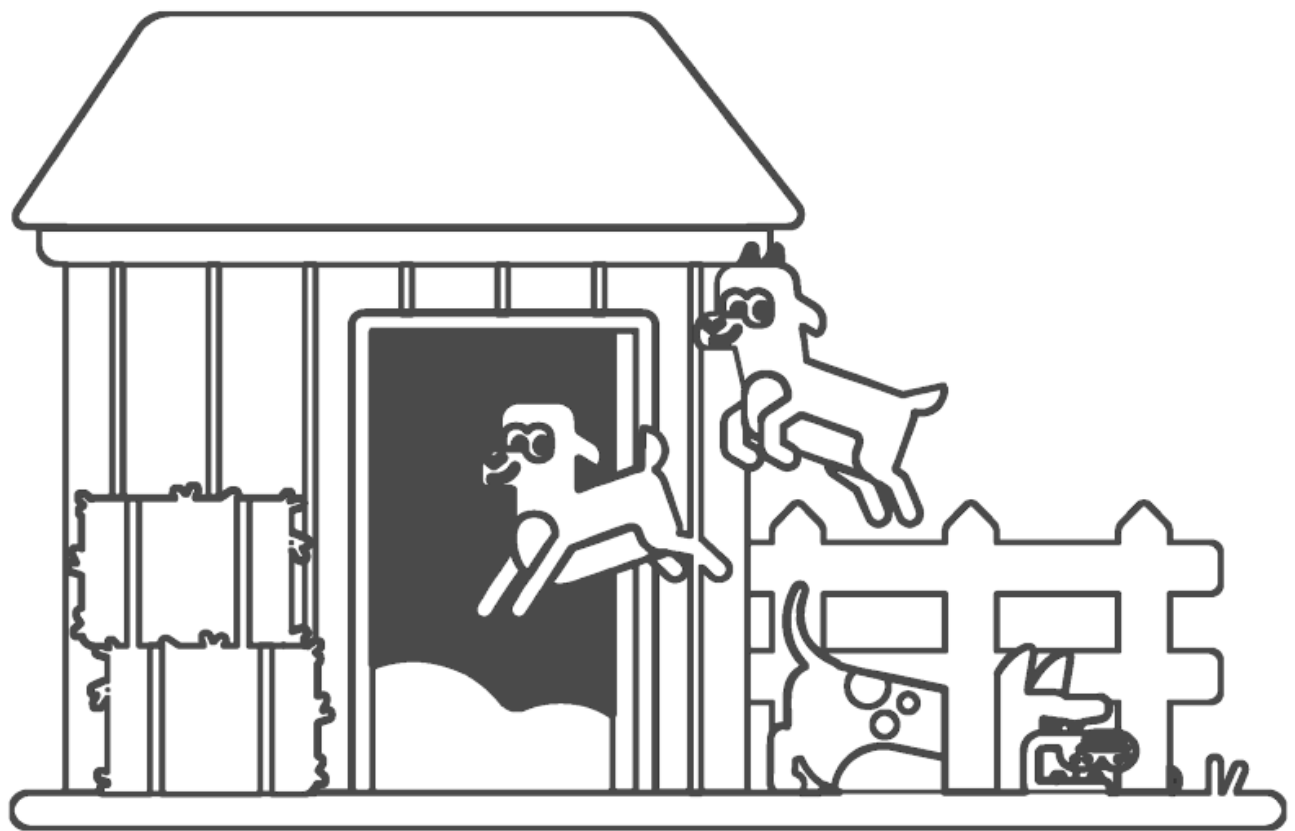

The goats go over.

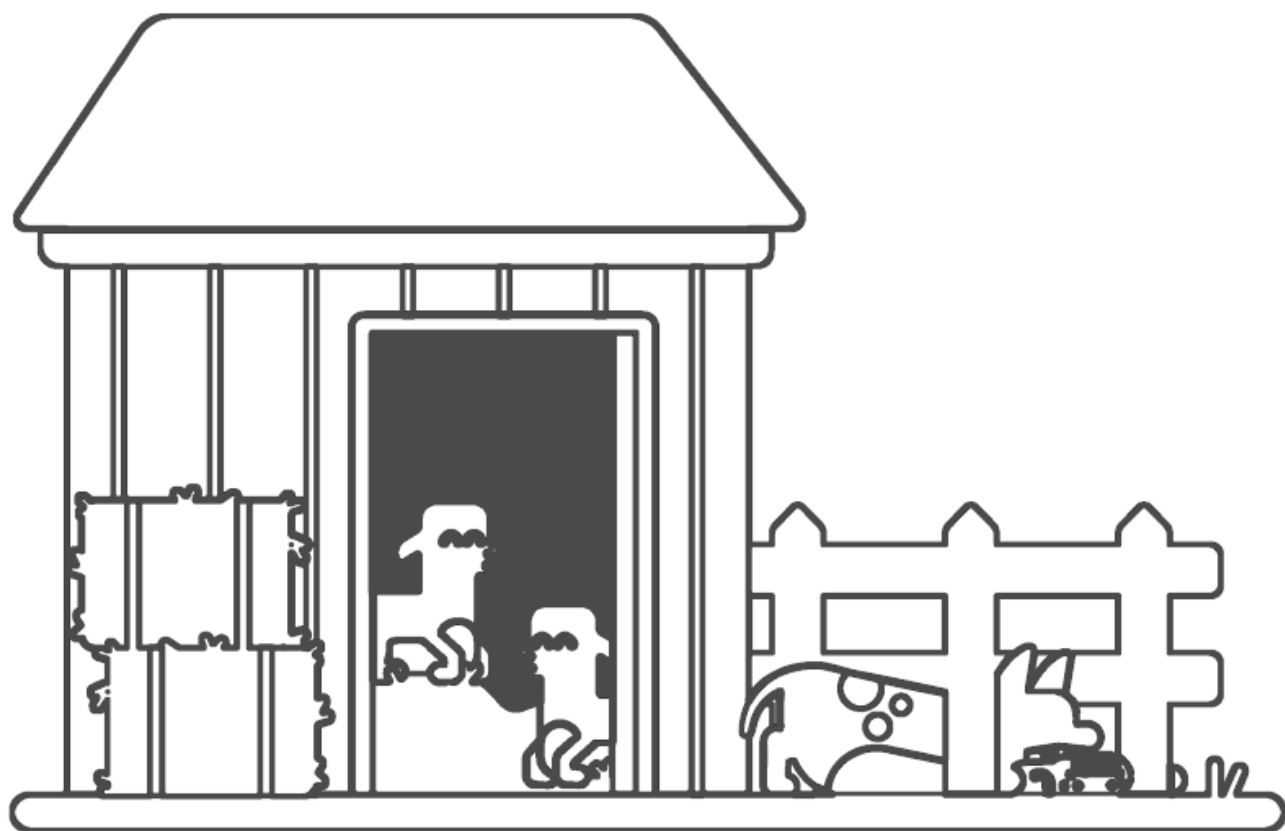

The goats go home.

H h

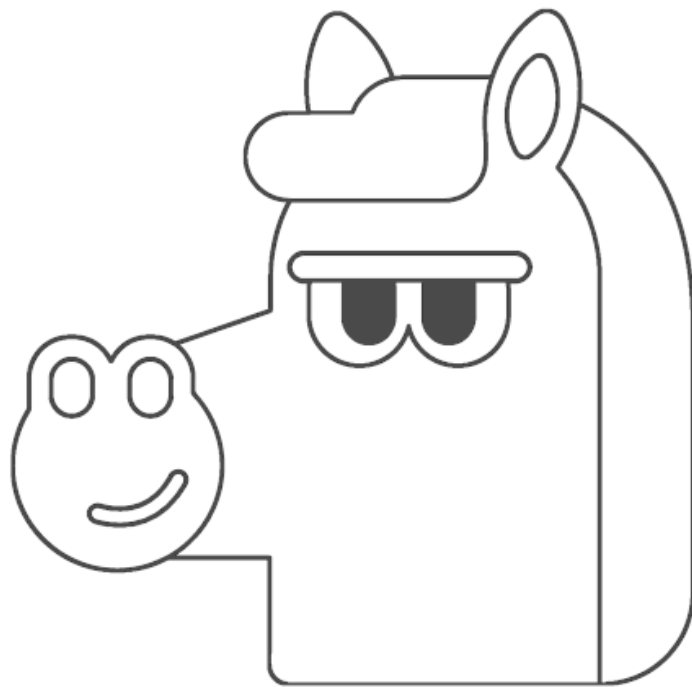

horse

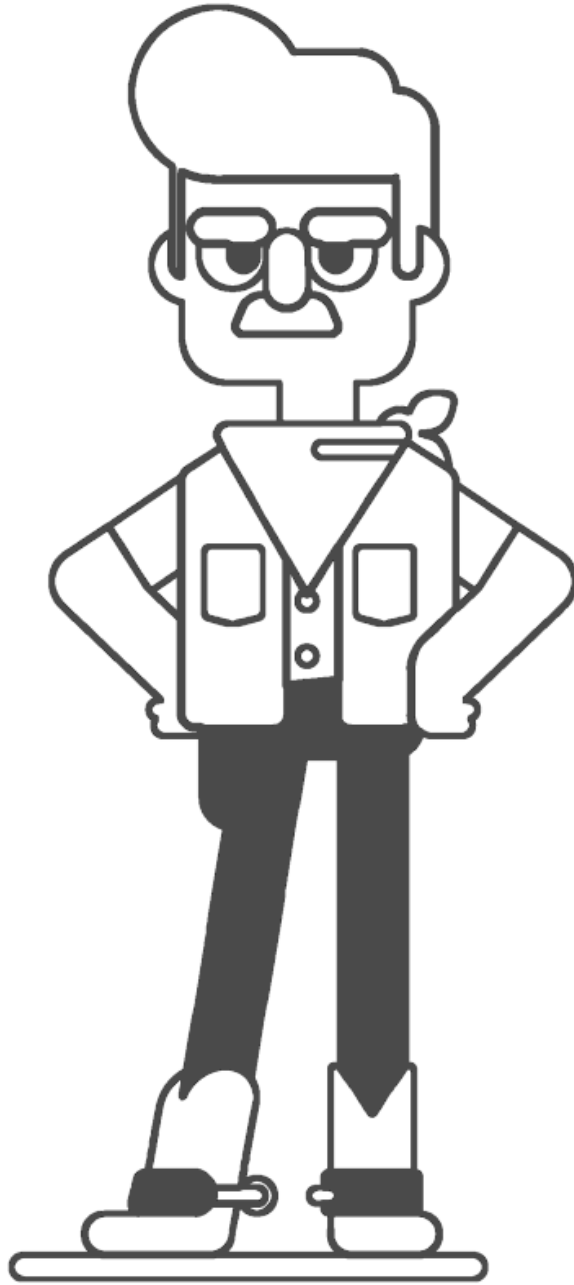

This is Hank.

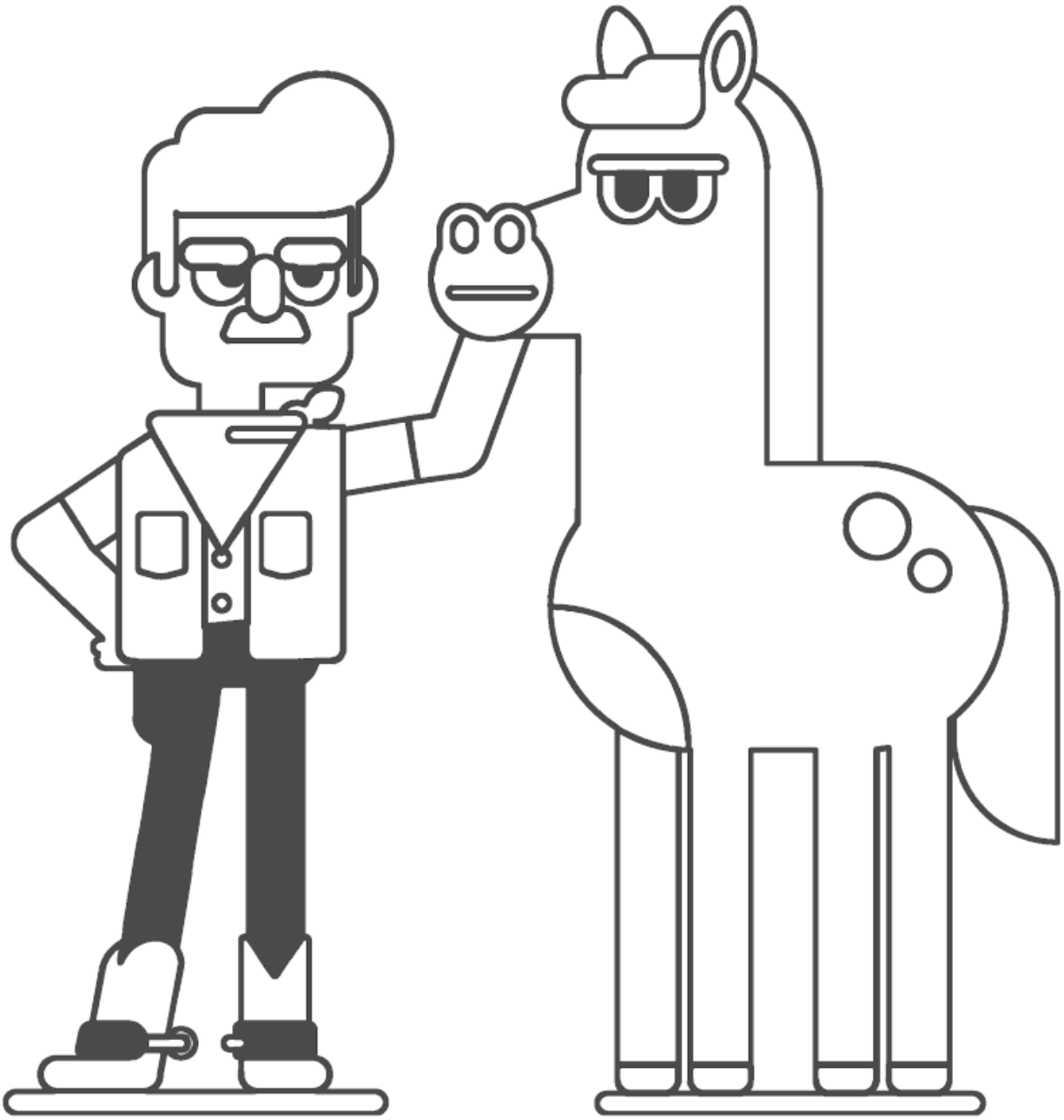

And this is his horse.

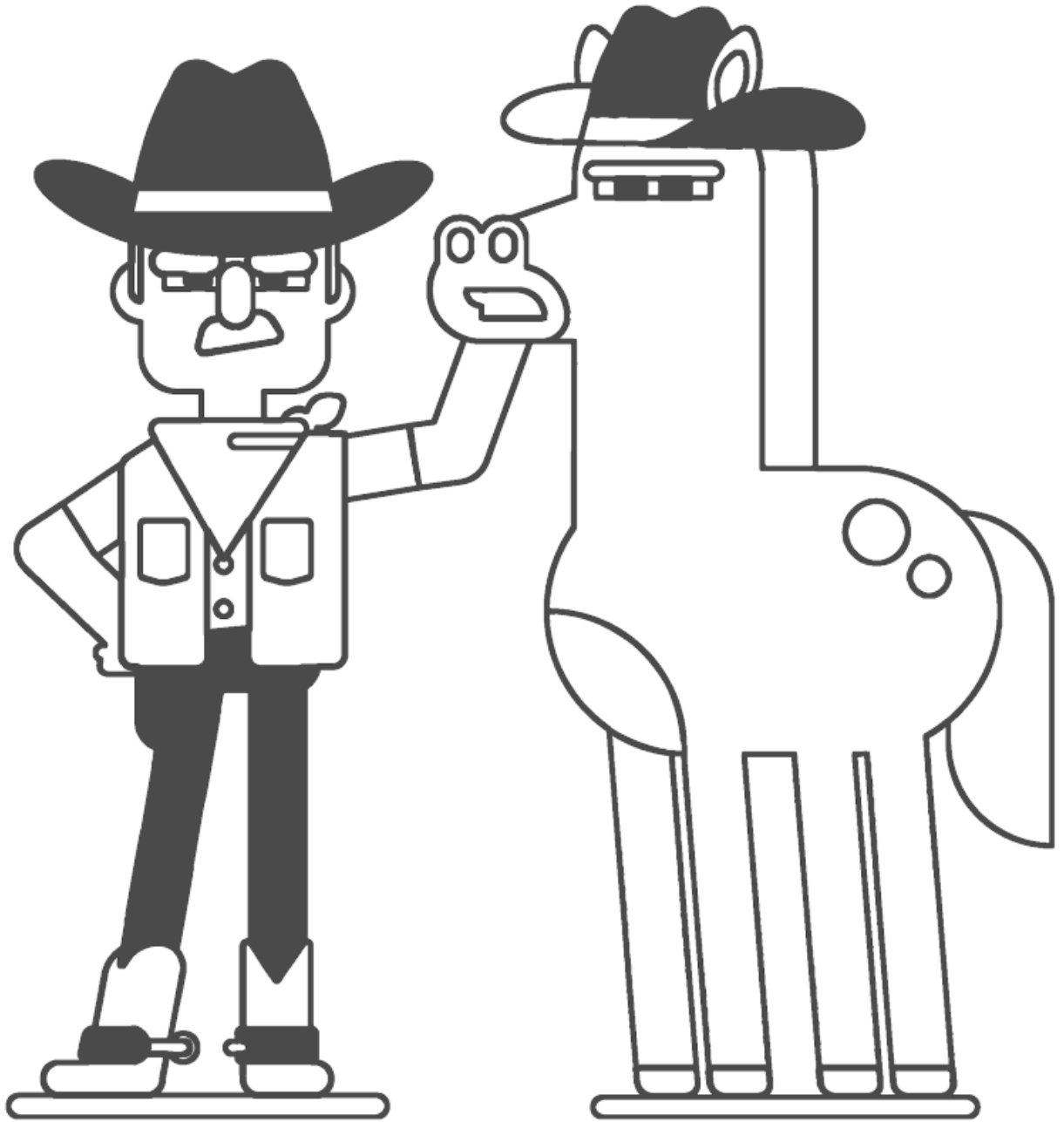

They have tall hats.

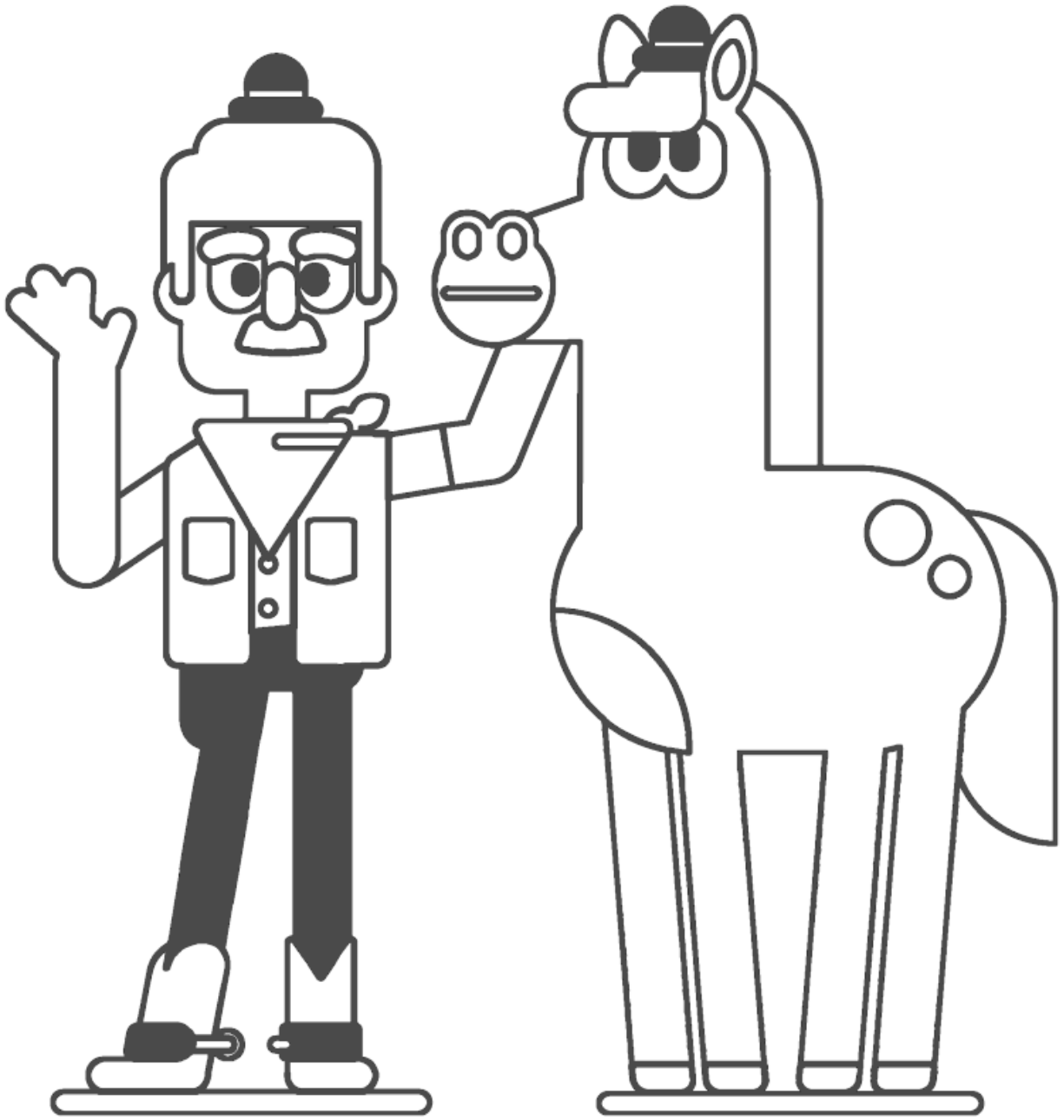

And small hats.

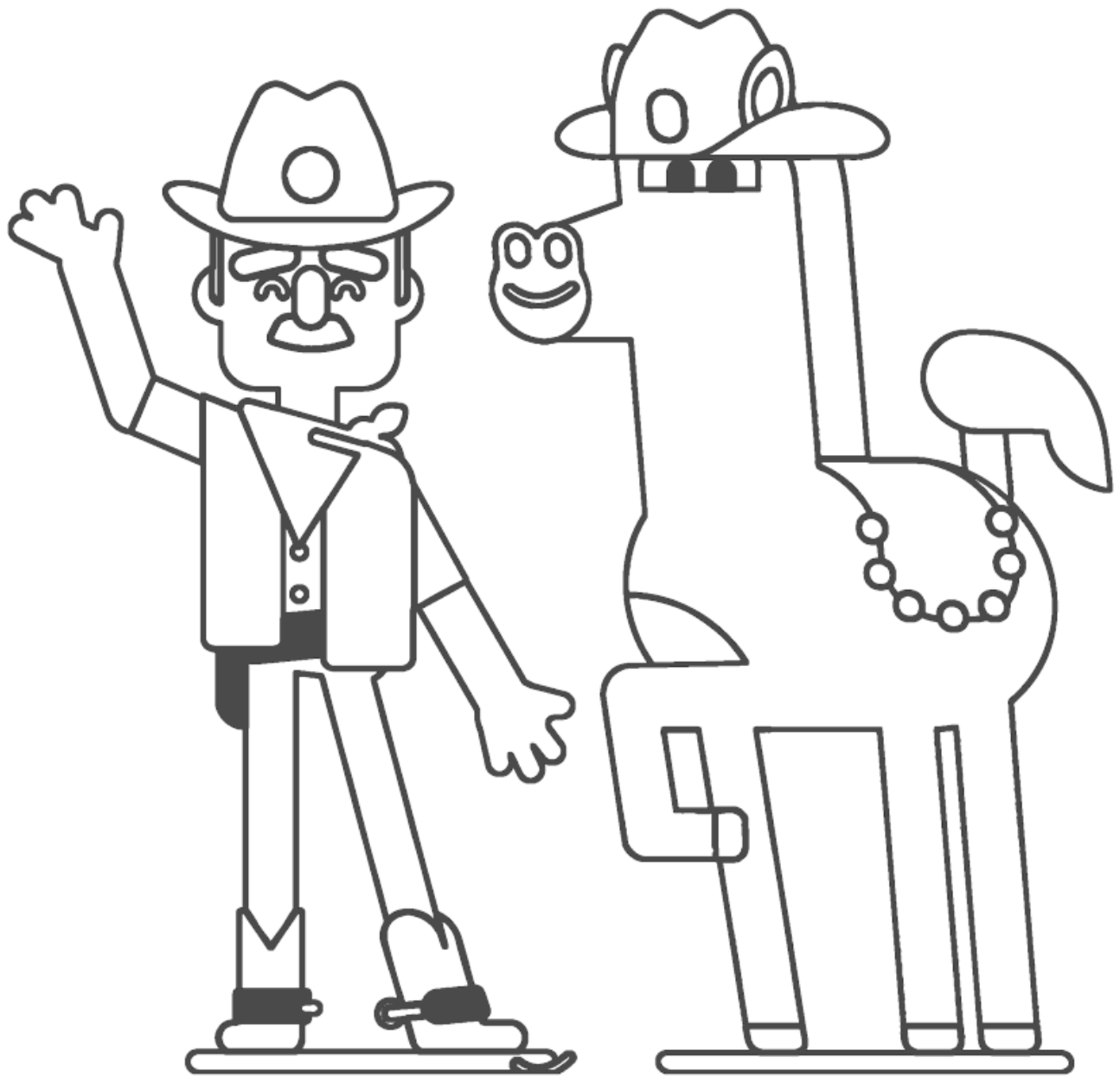

They have blue hats.

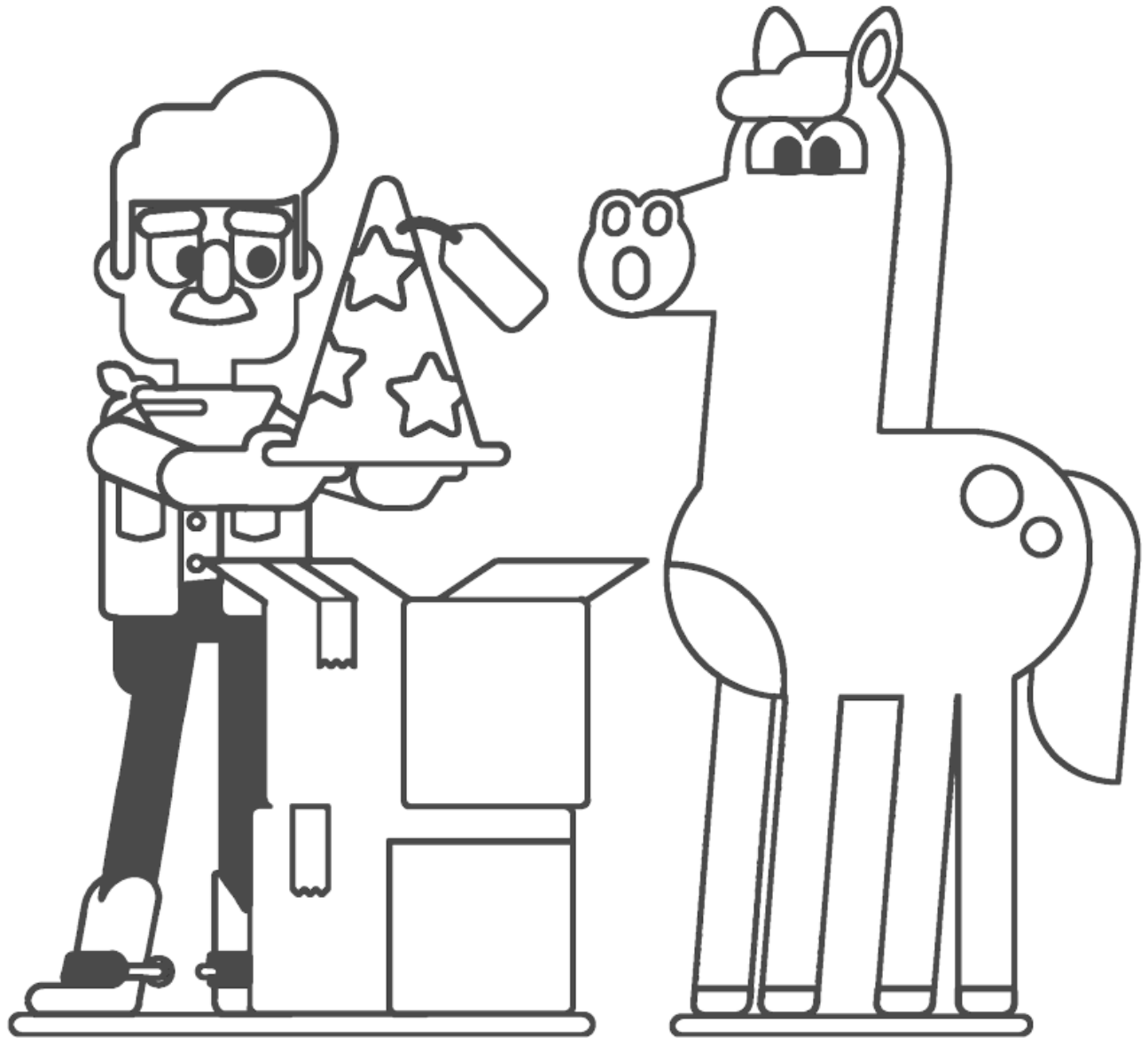

And new hats.

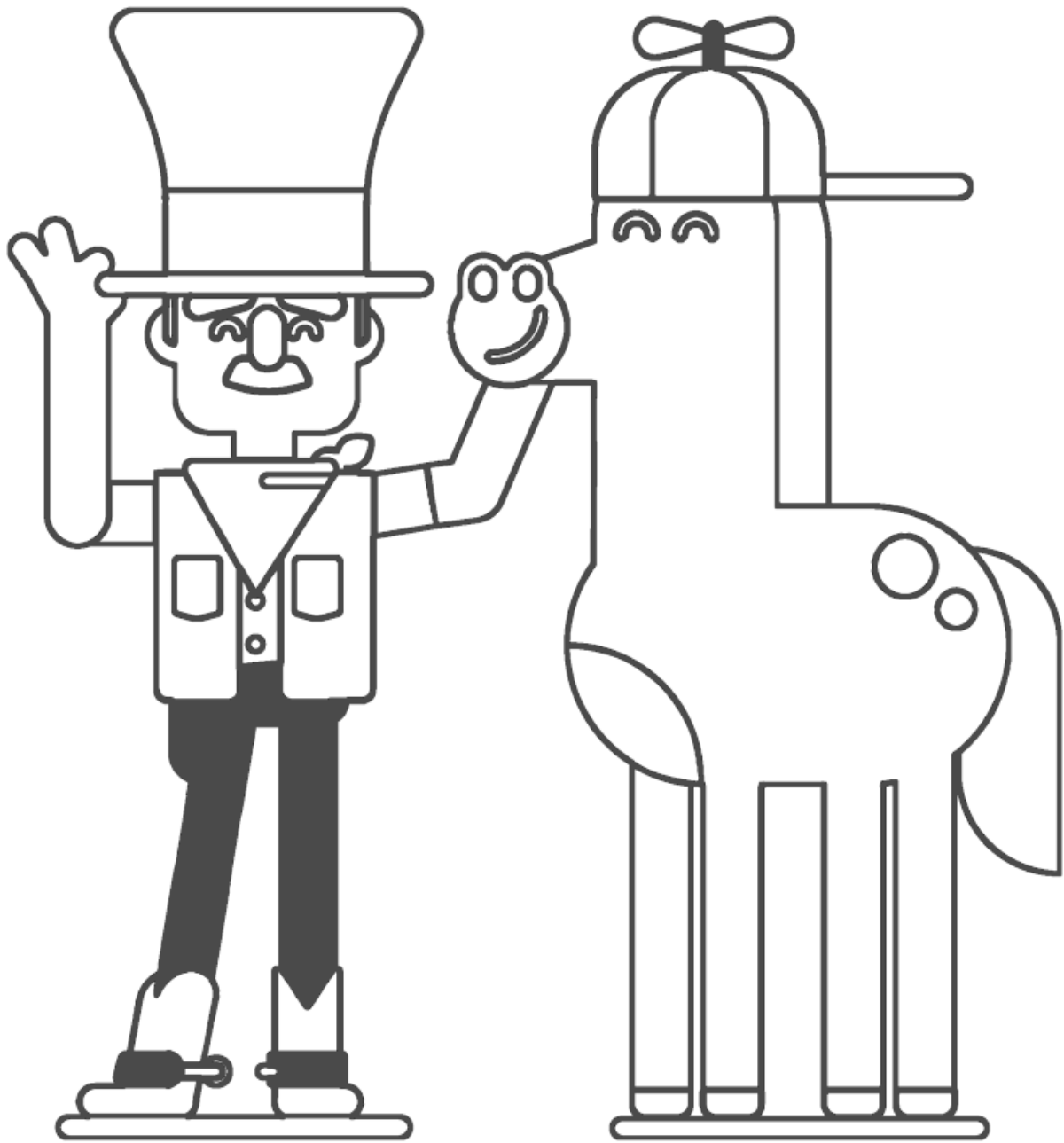

They have funny hats.

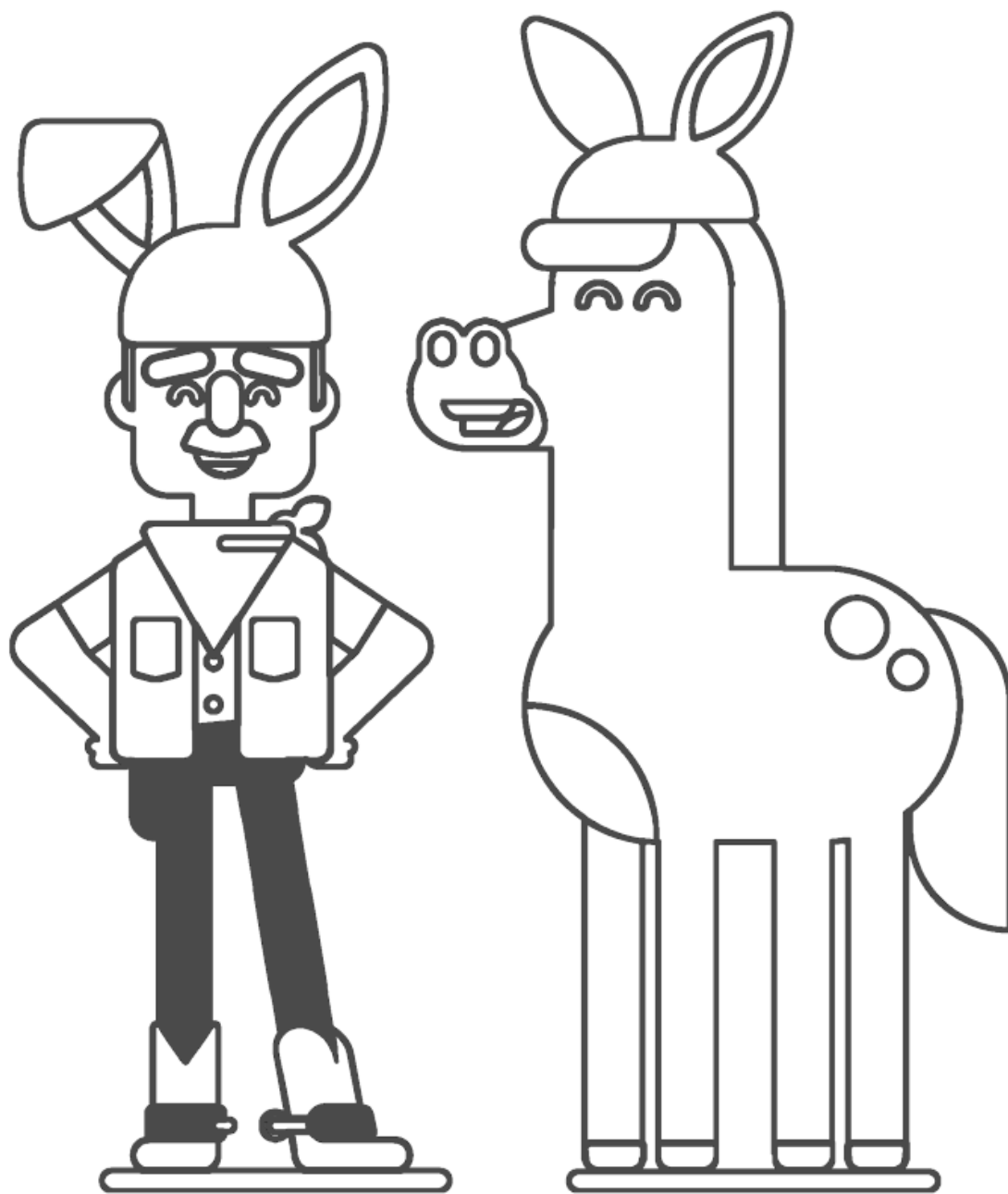

And funny bunny hats!

I i

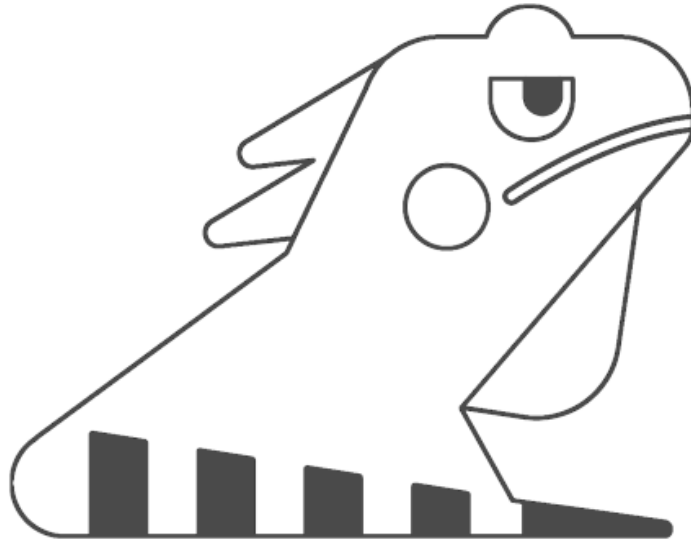

iguana

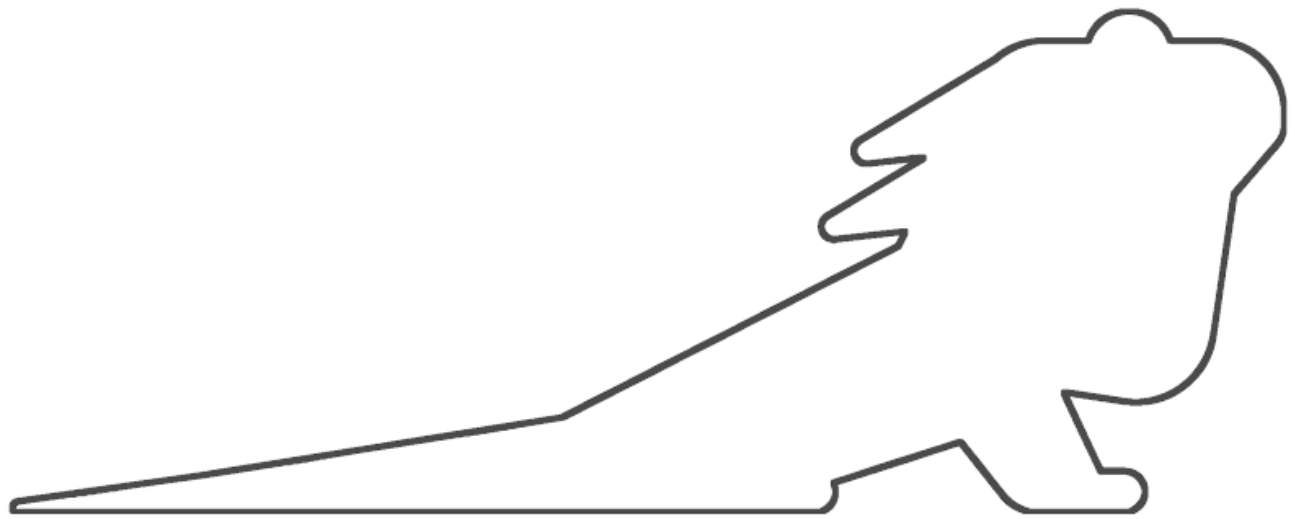

It is long.

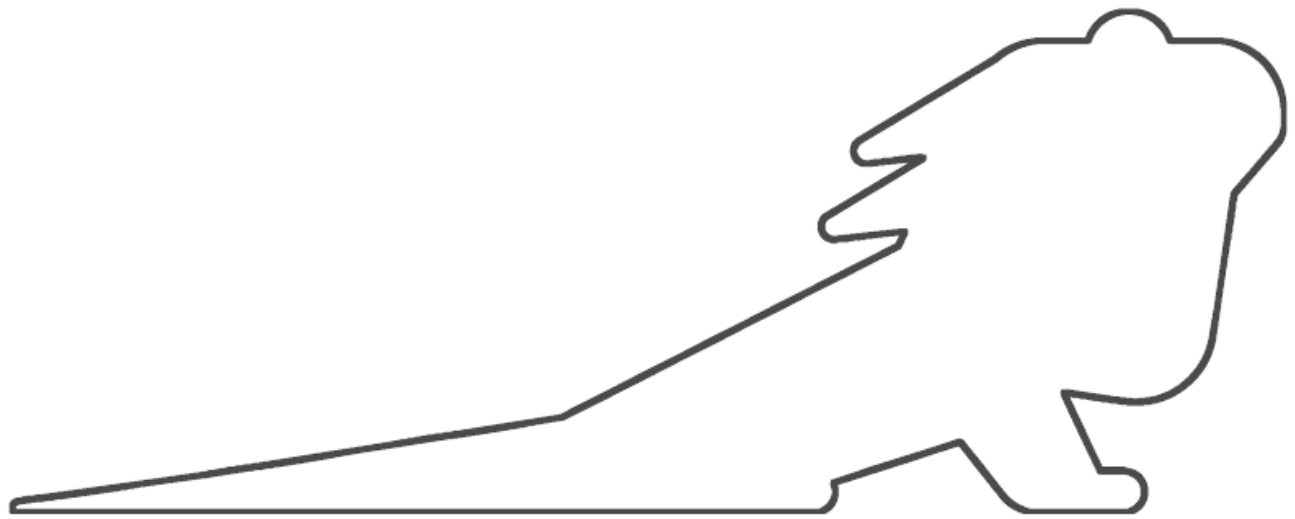

It is green.

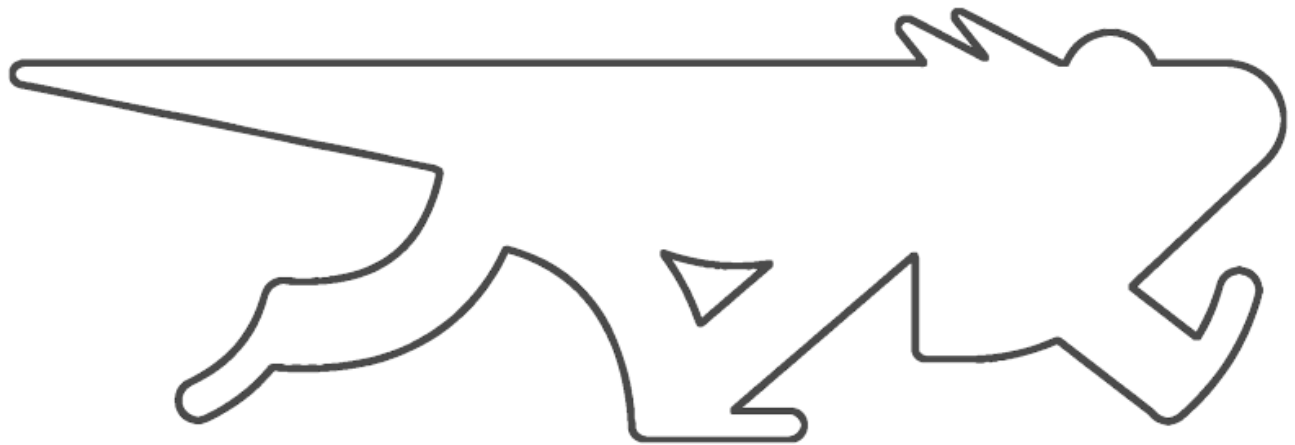

It is fast.

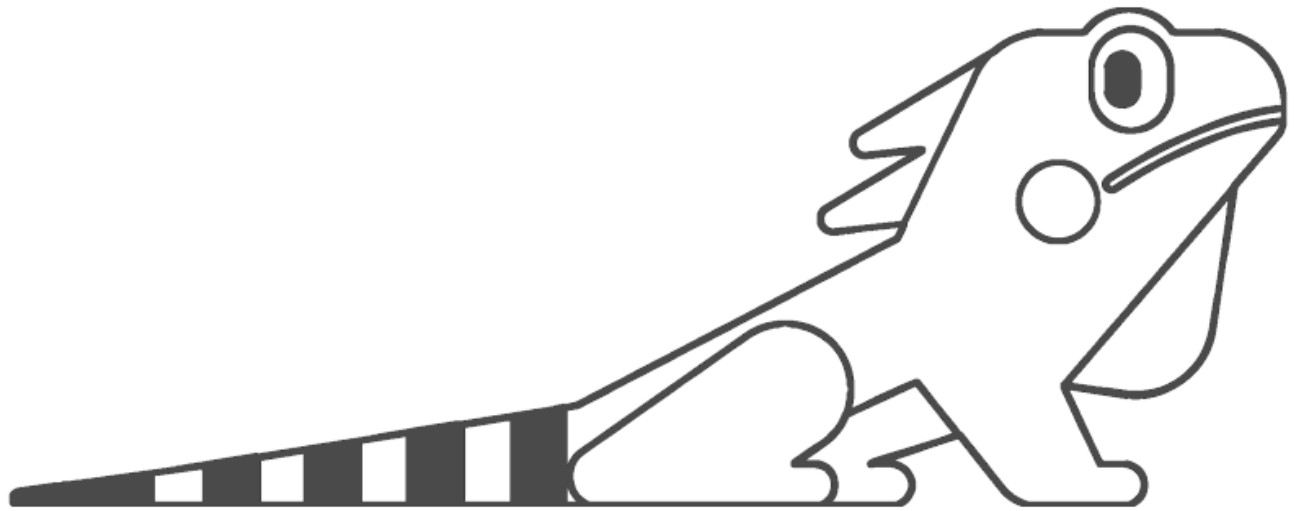

It is an iguana!

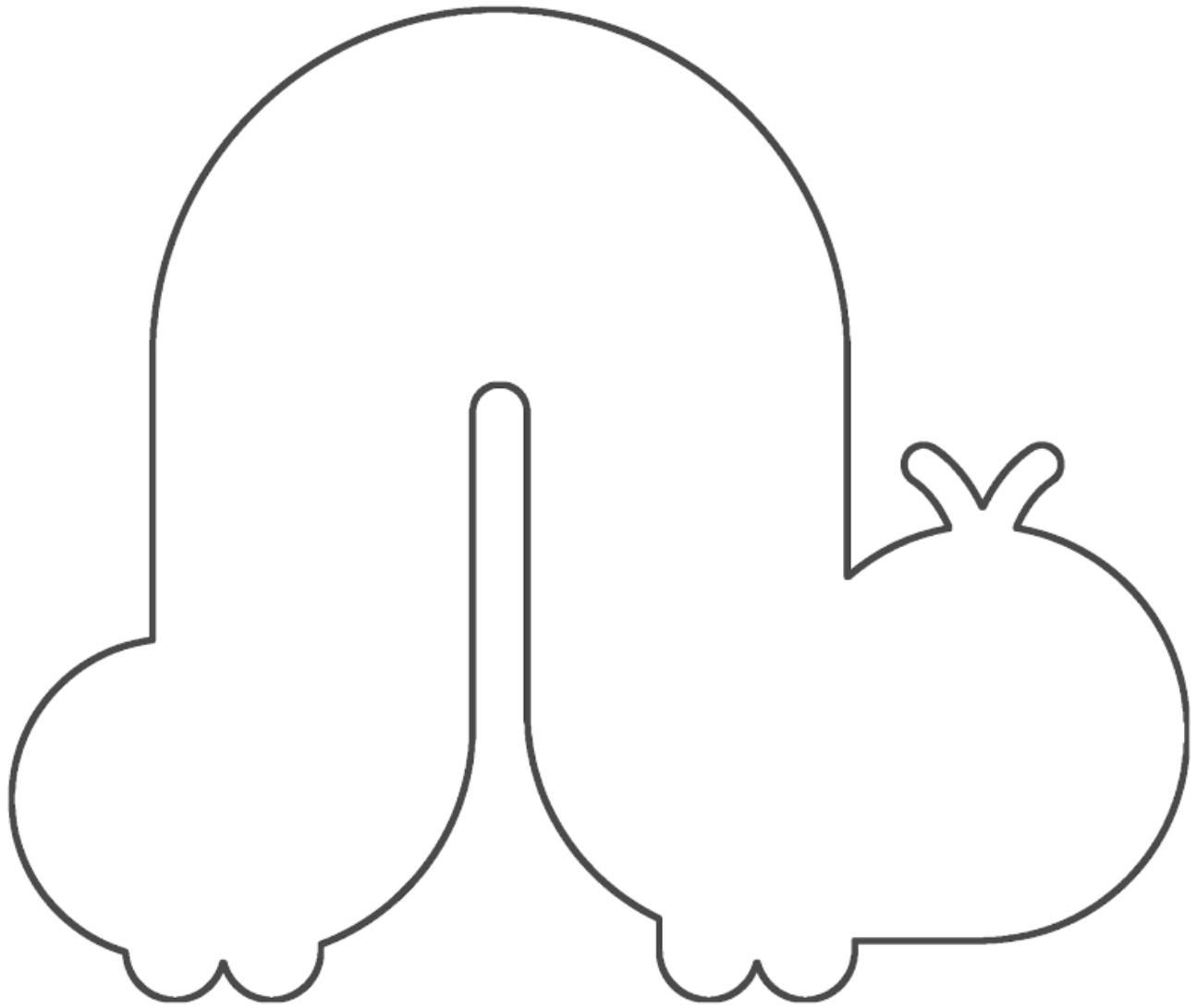

It is short.

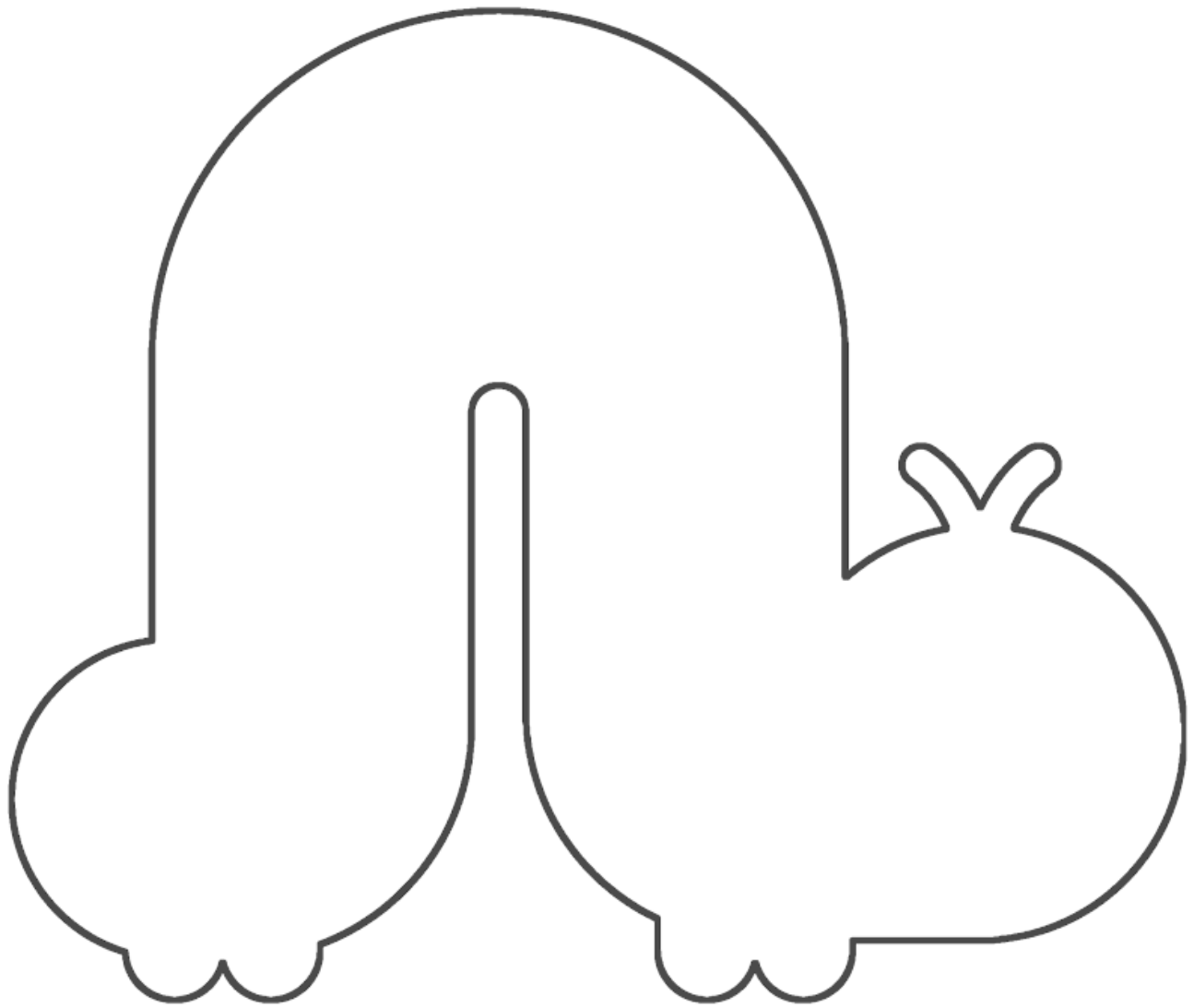

It is green.

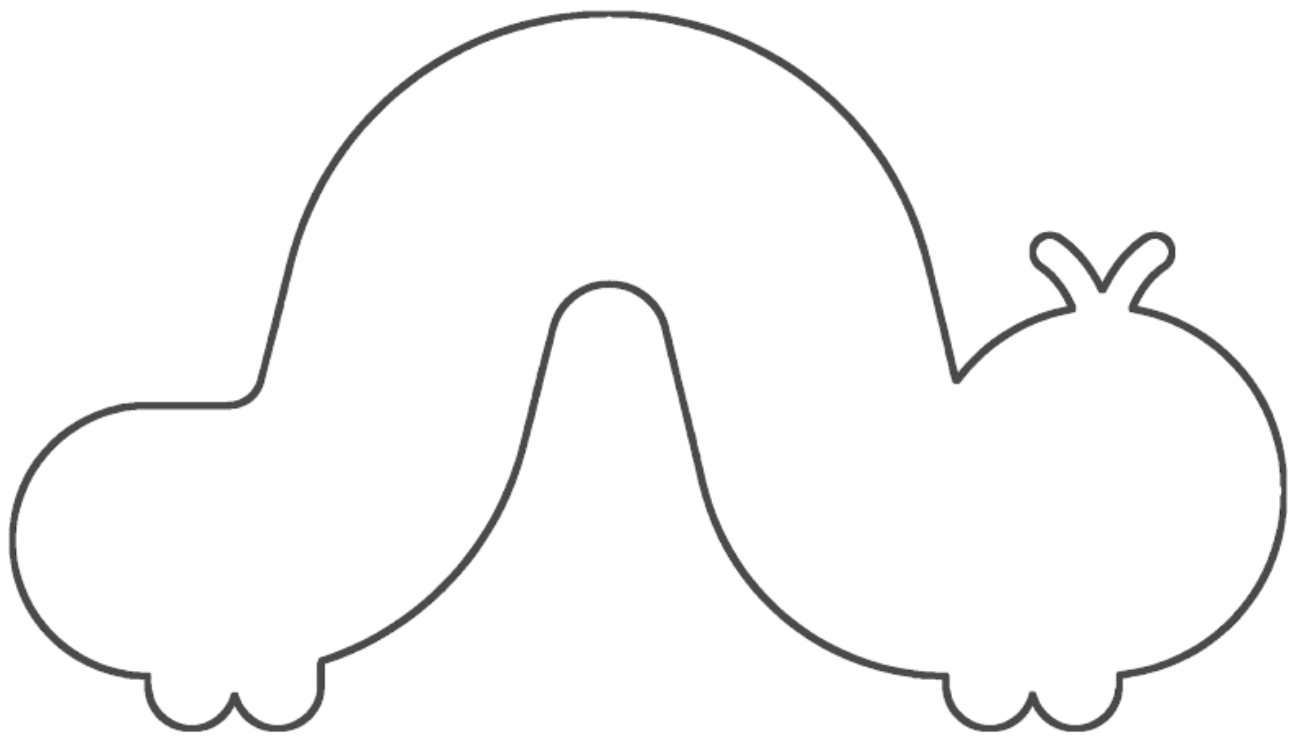

It is slow.

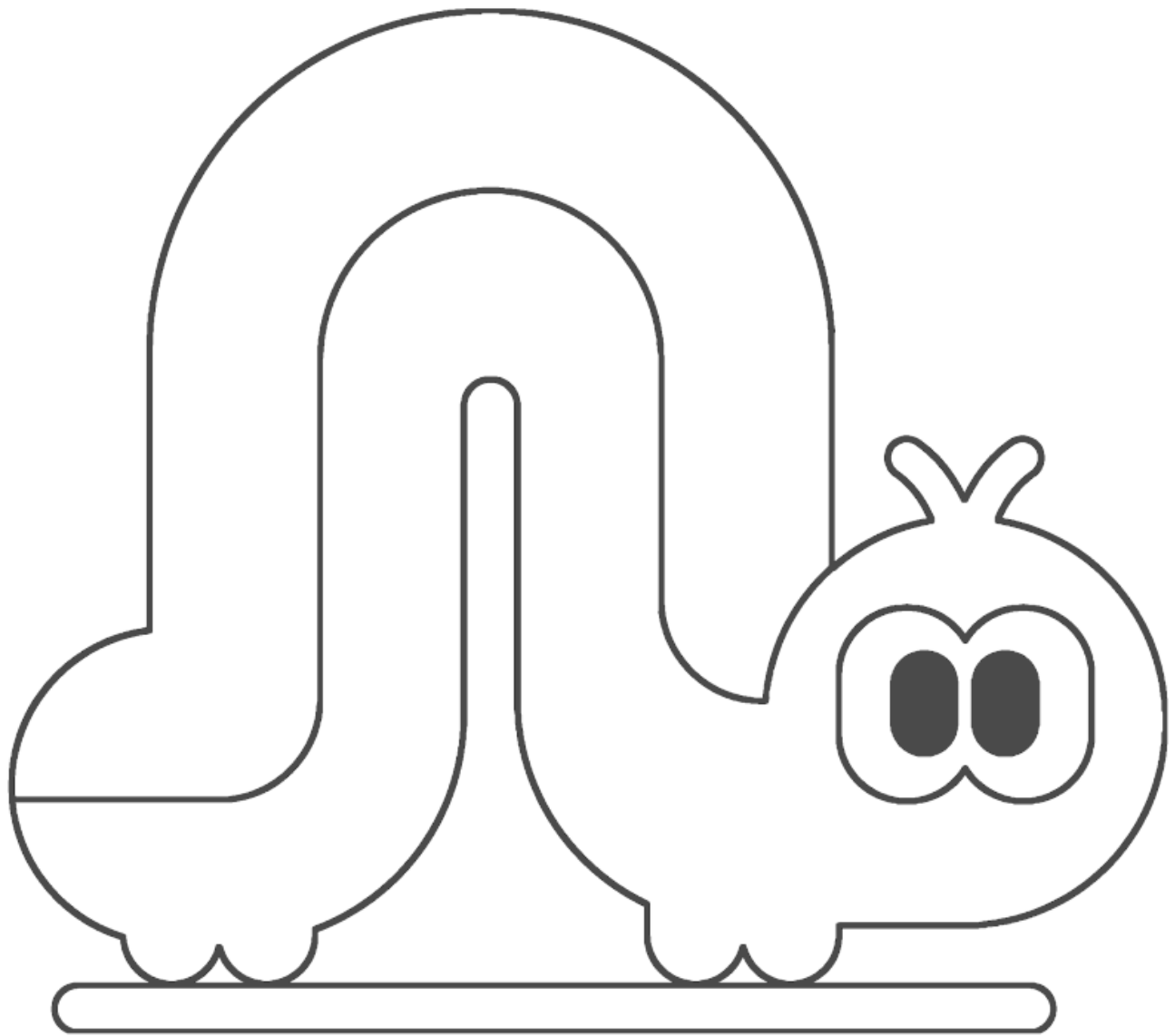

It is an inchworm!

J j

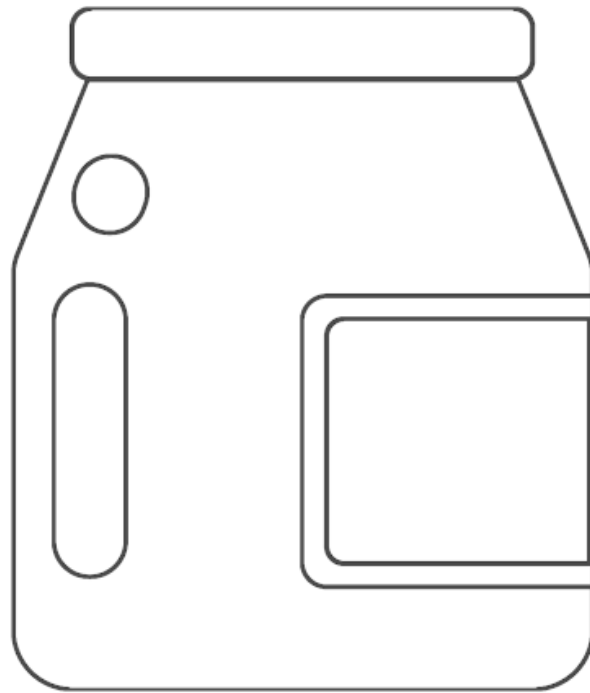

jar

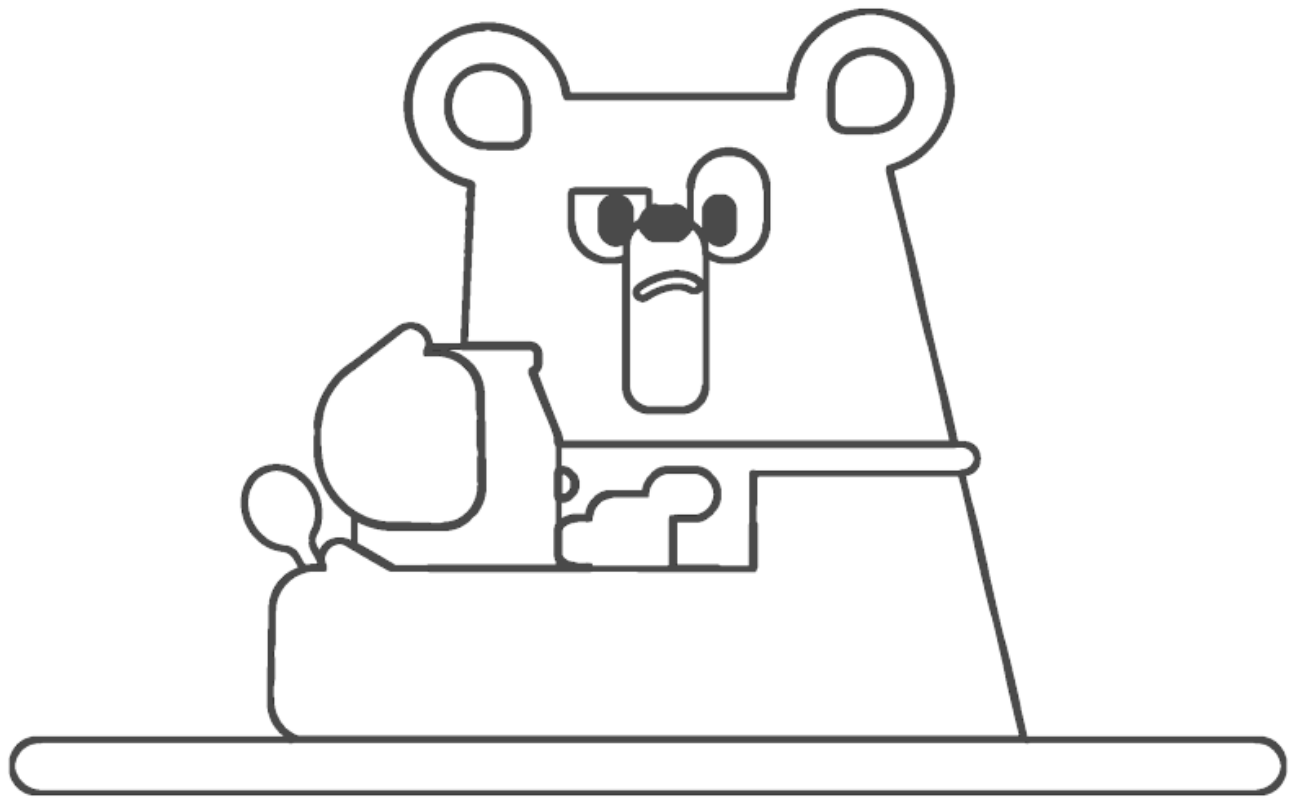

**How much jam did Jem
eat?**

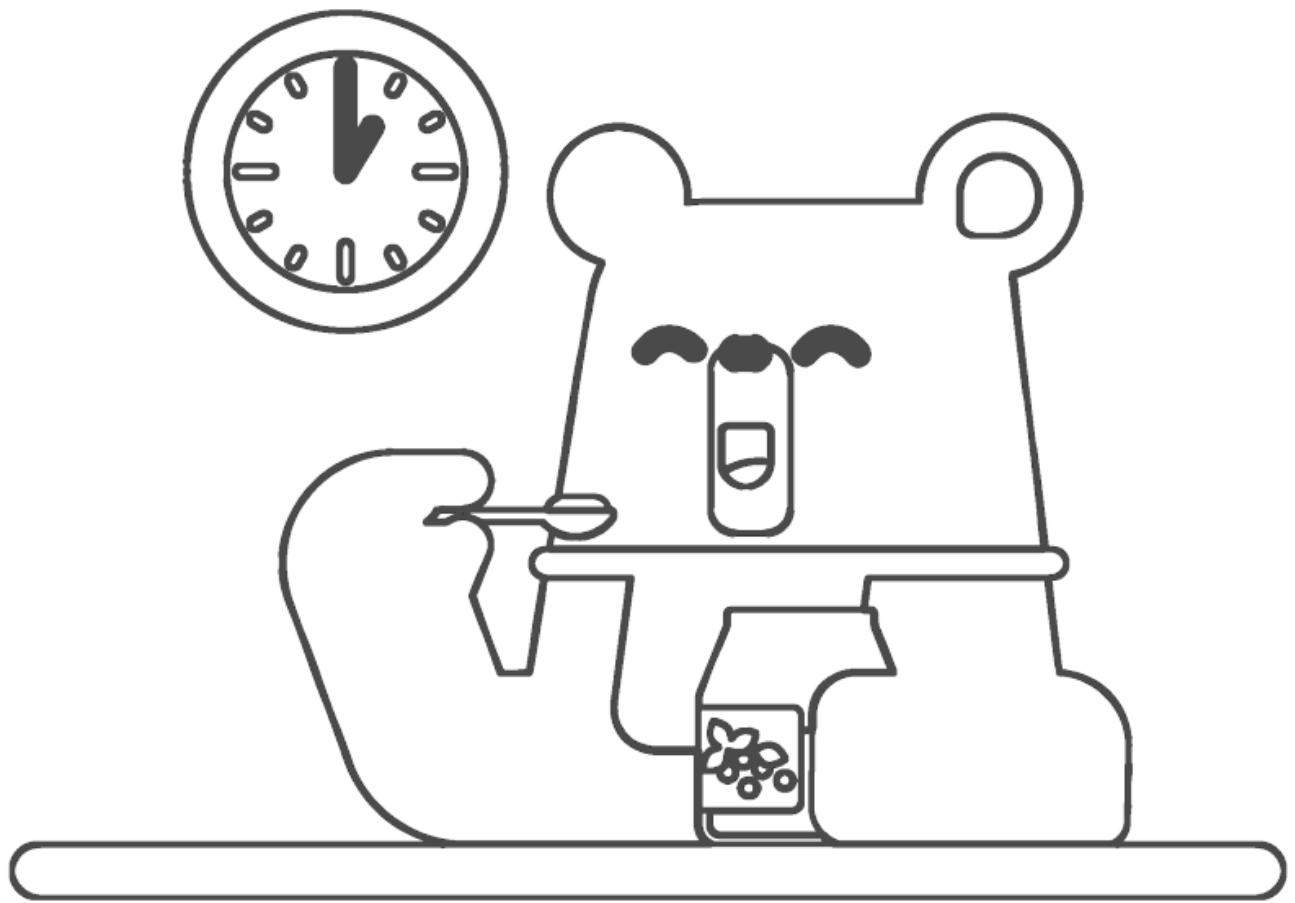

She ate a jar at one.

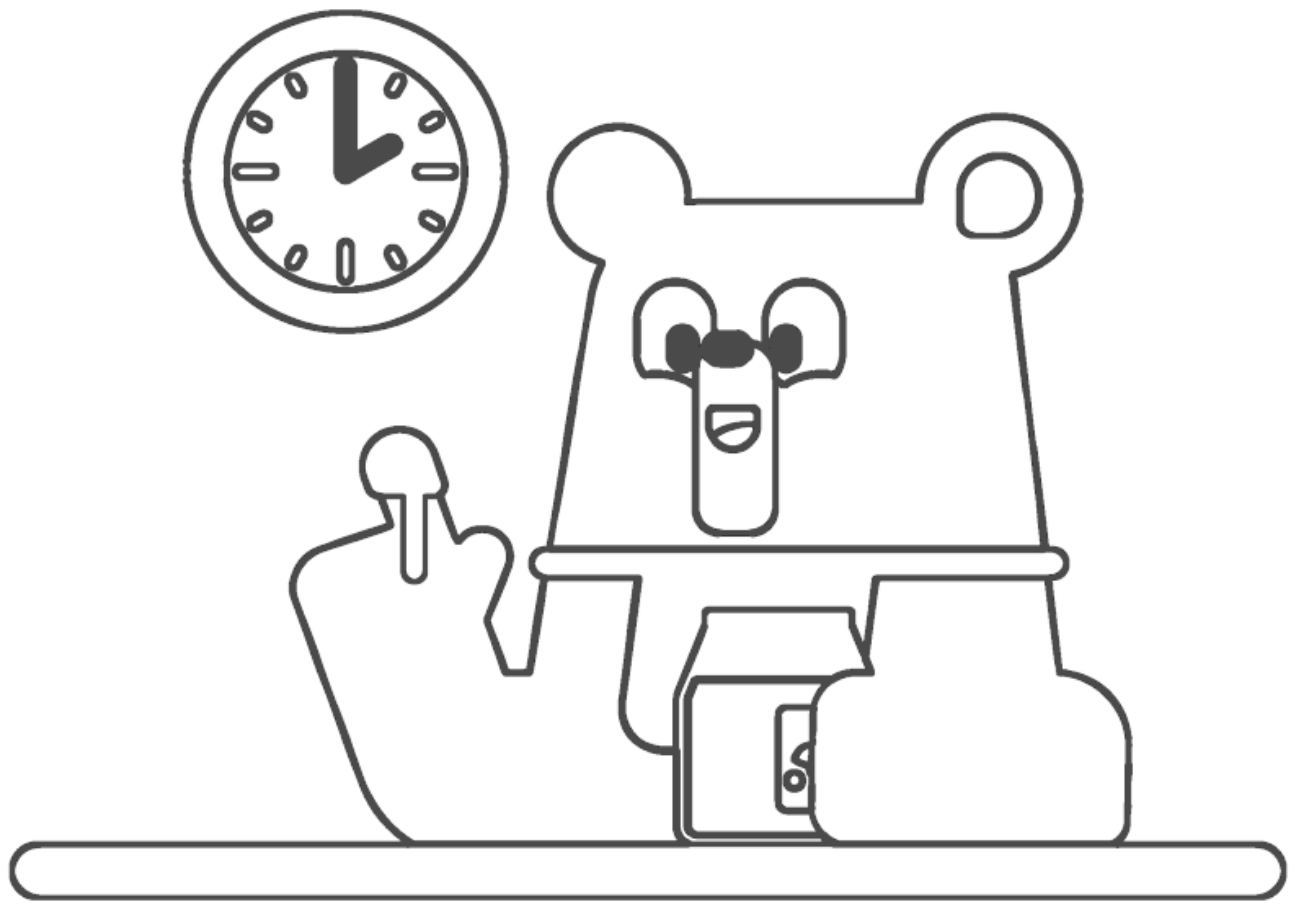

She ate a jar at two.

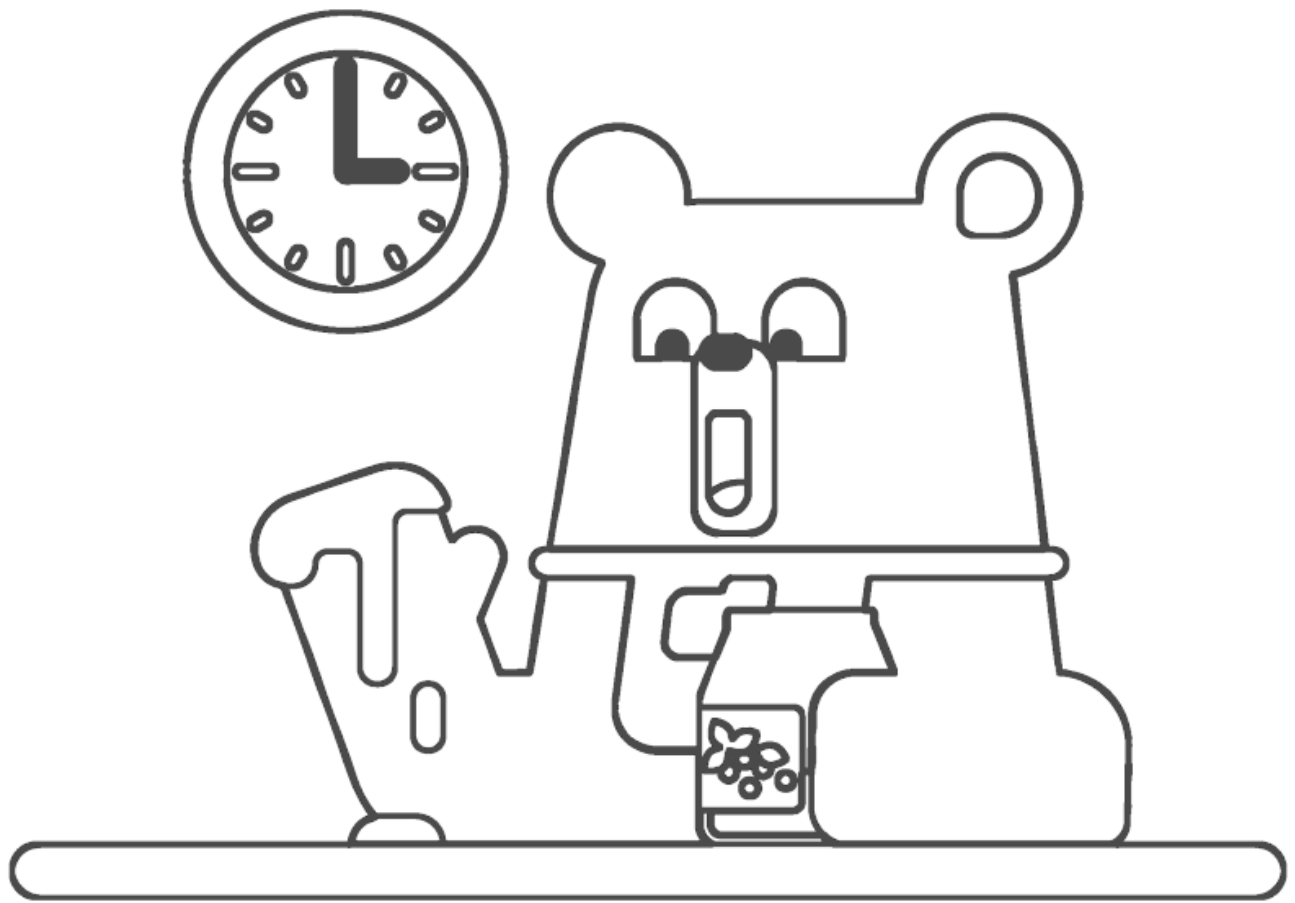

She ate a jar at three.

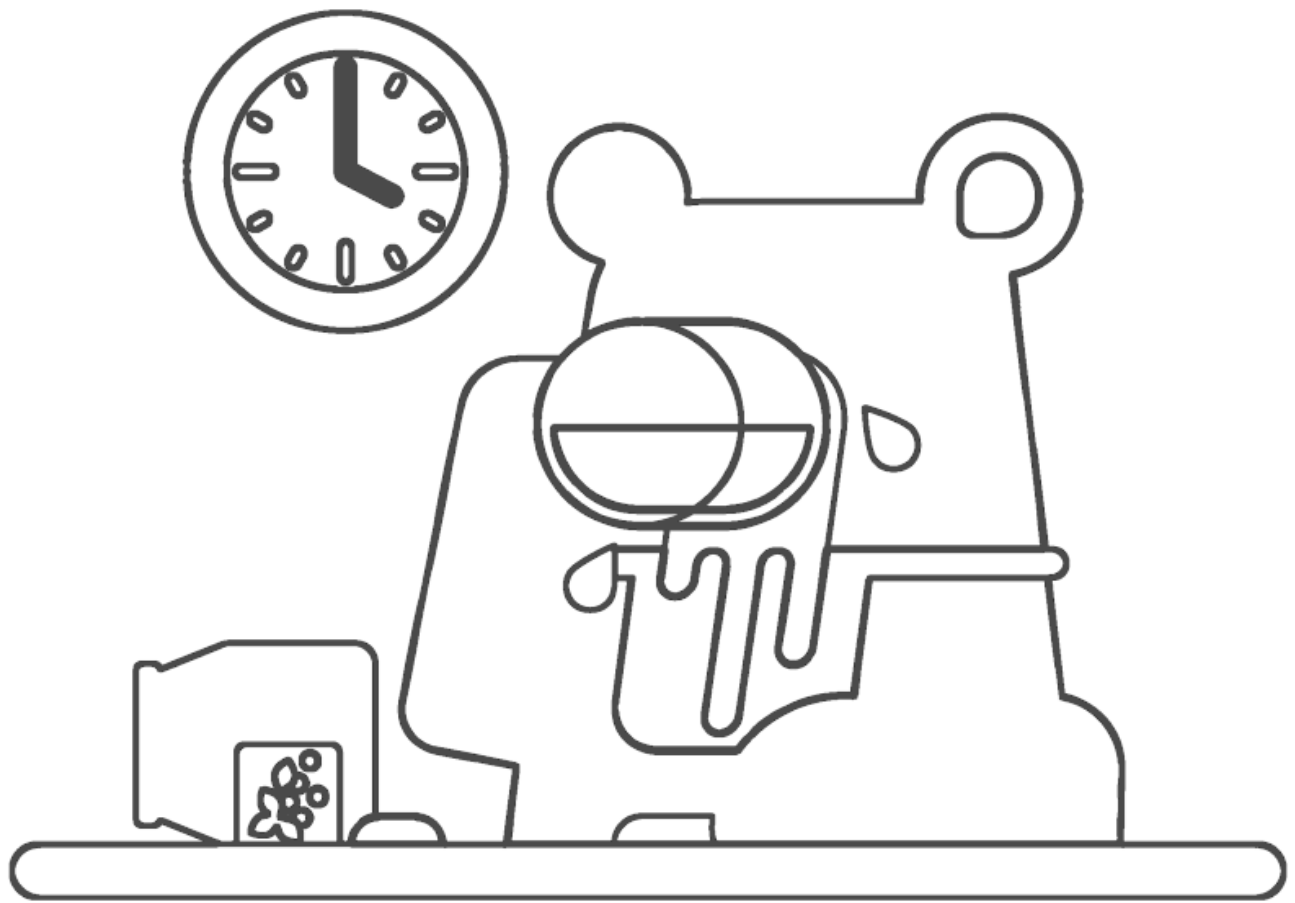

**And one more jar at
four.**

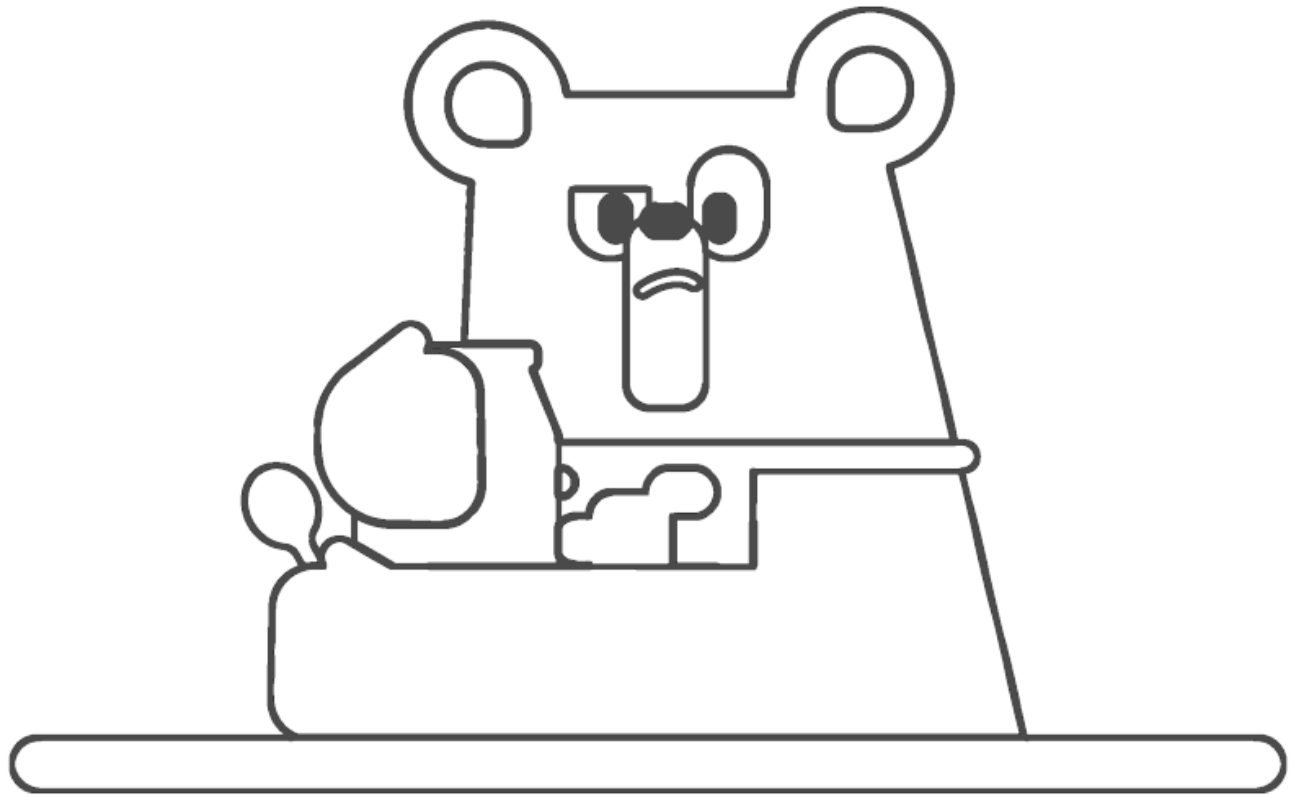

**How much jam did Jem
eat?**

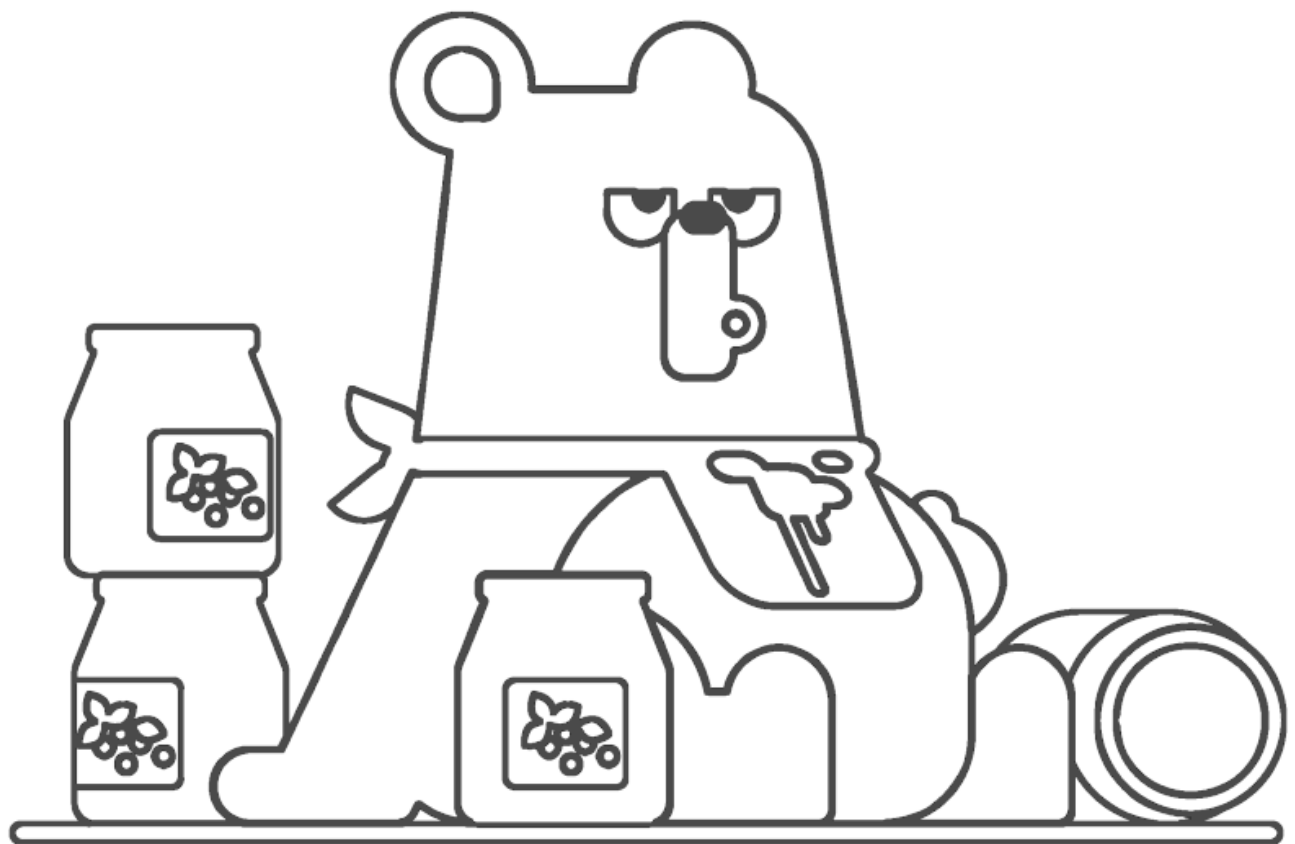

**Jem ate four jars of
jam!**

K k

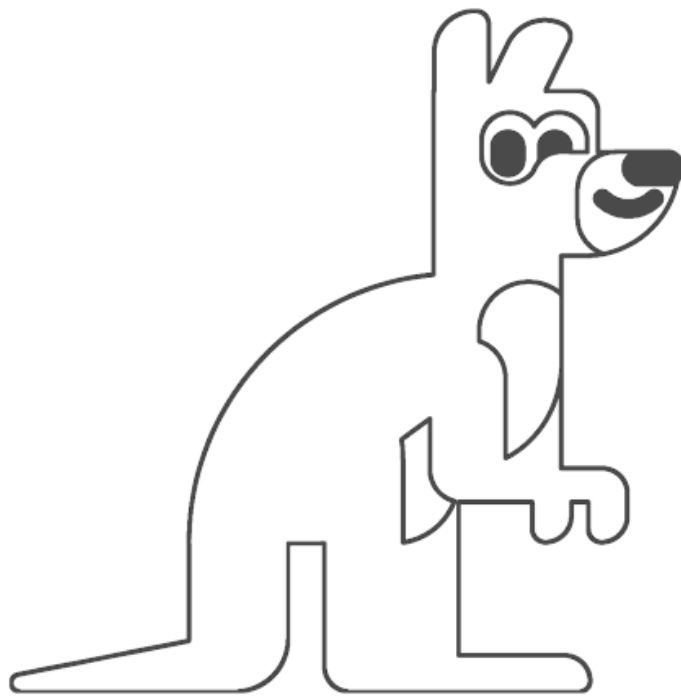

kangaroo

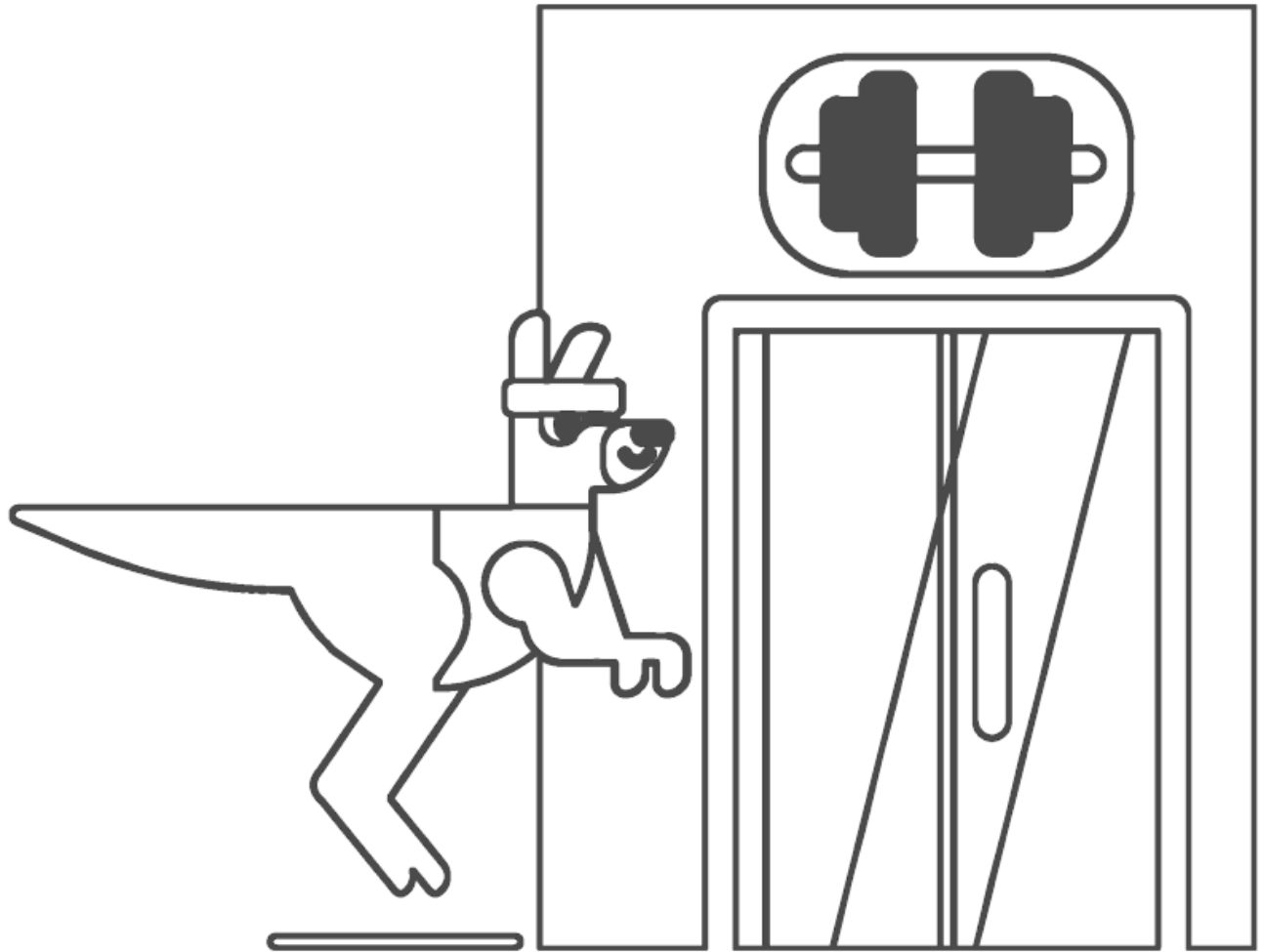

Ken went to the gym.

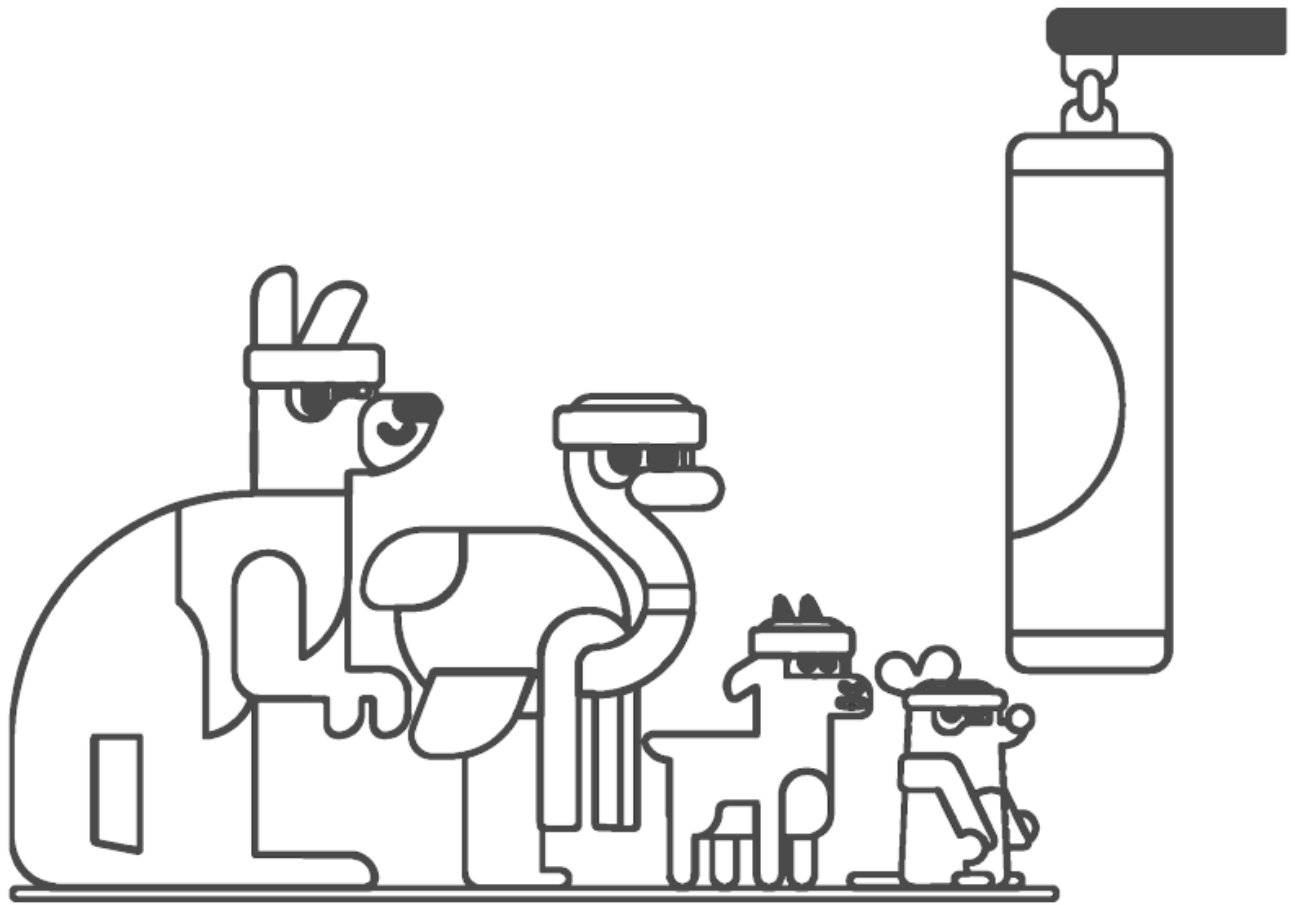

**He saw all kinds of
kicks.**



There was a high kick.

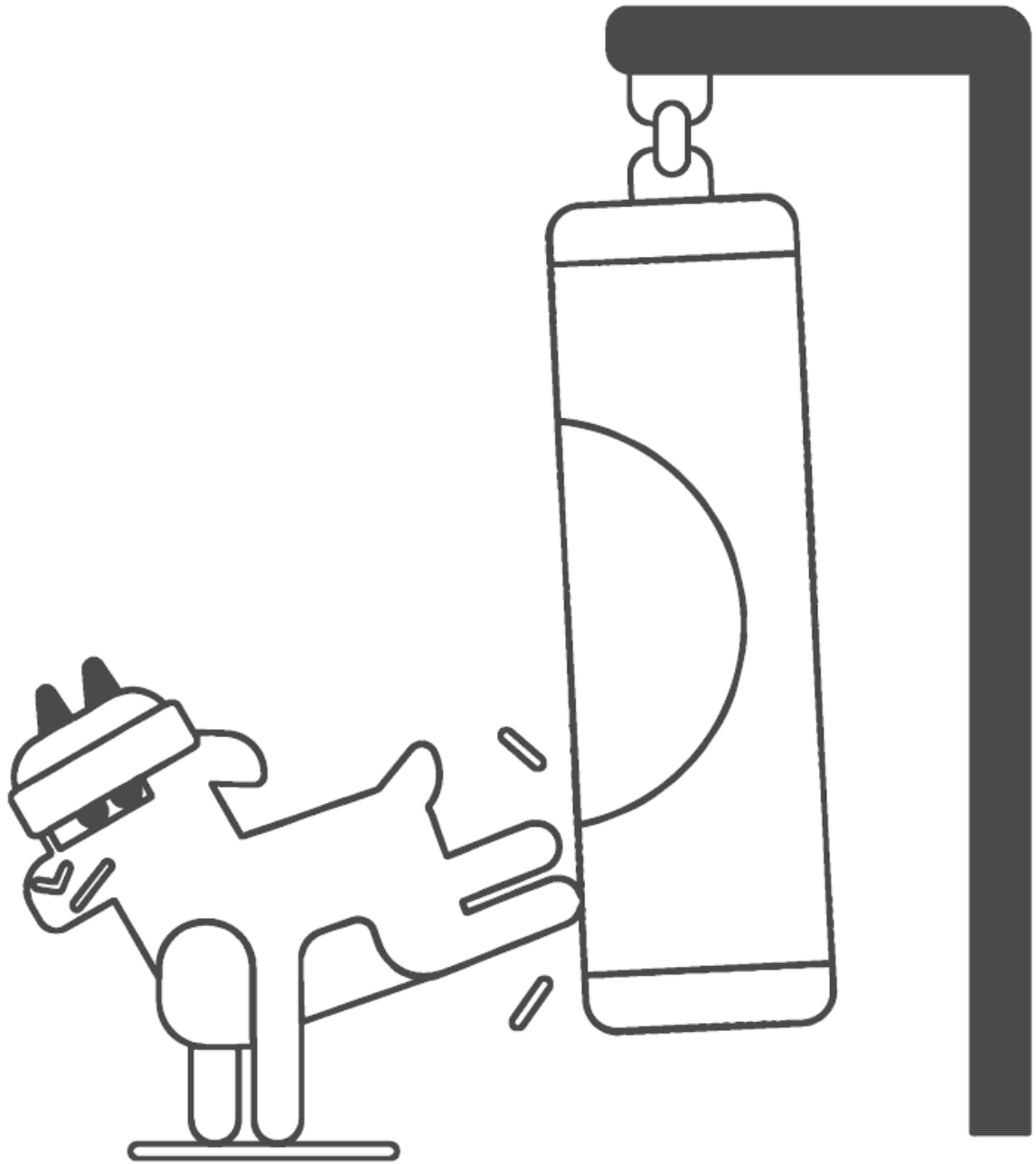

And a low kick.

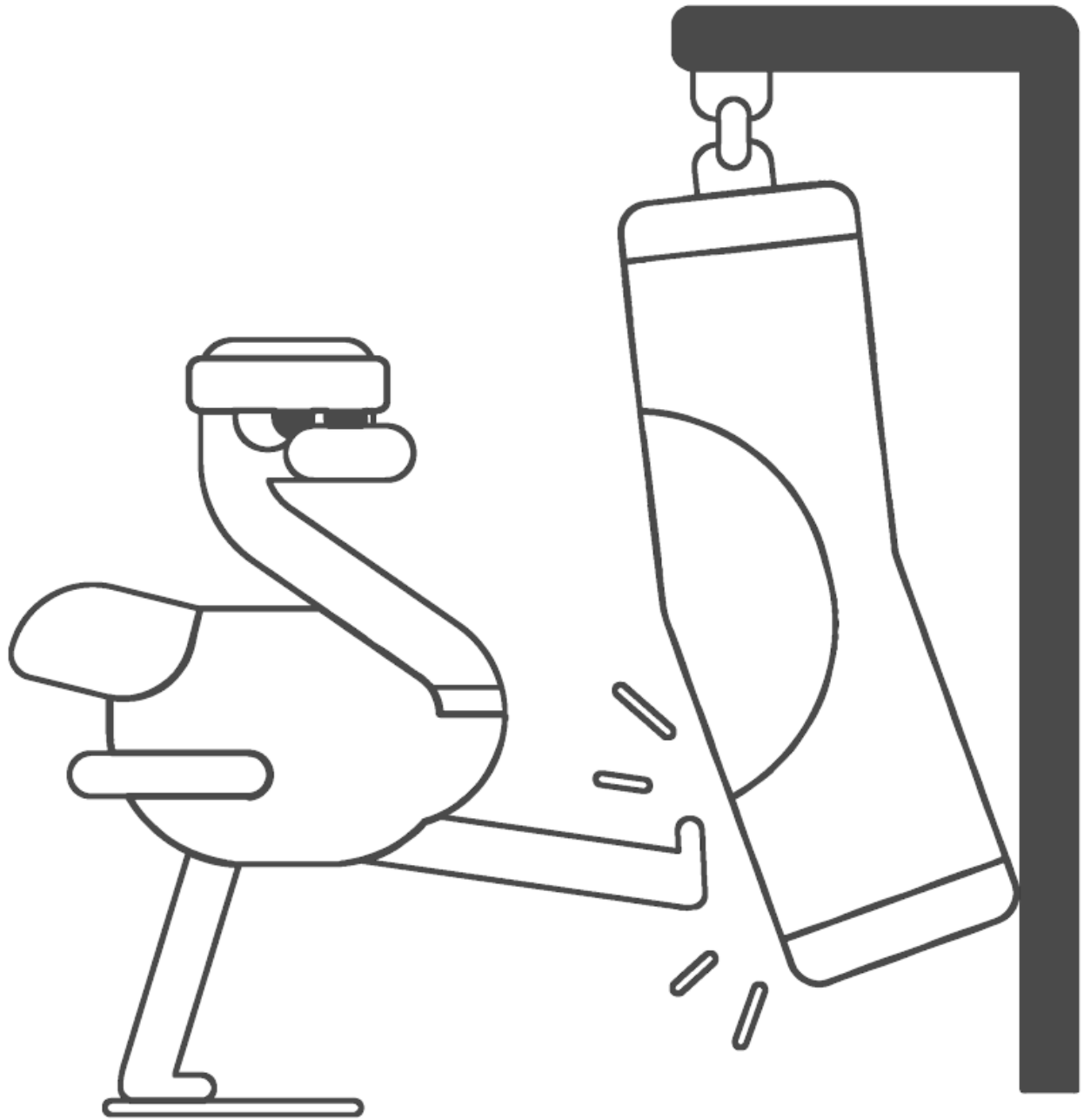

And even a front kick.

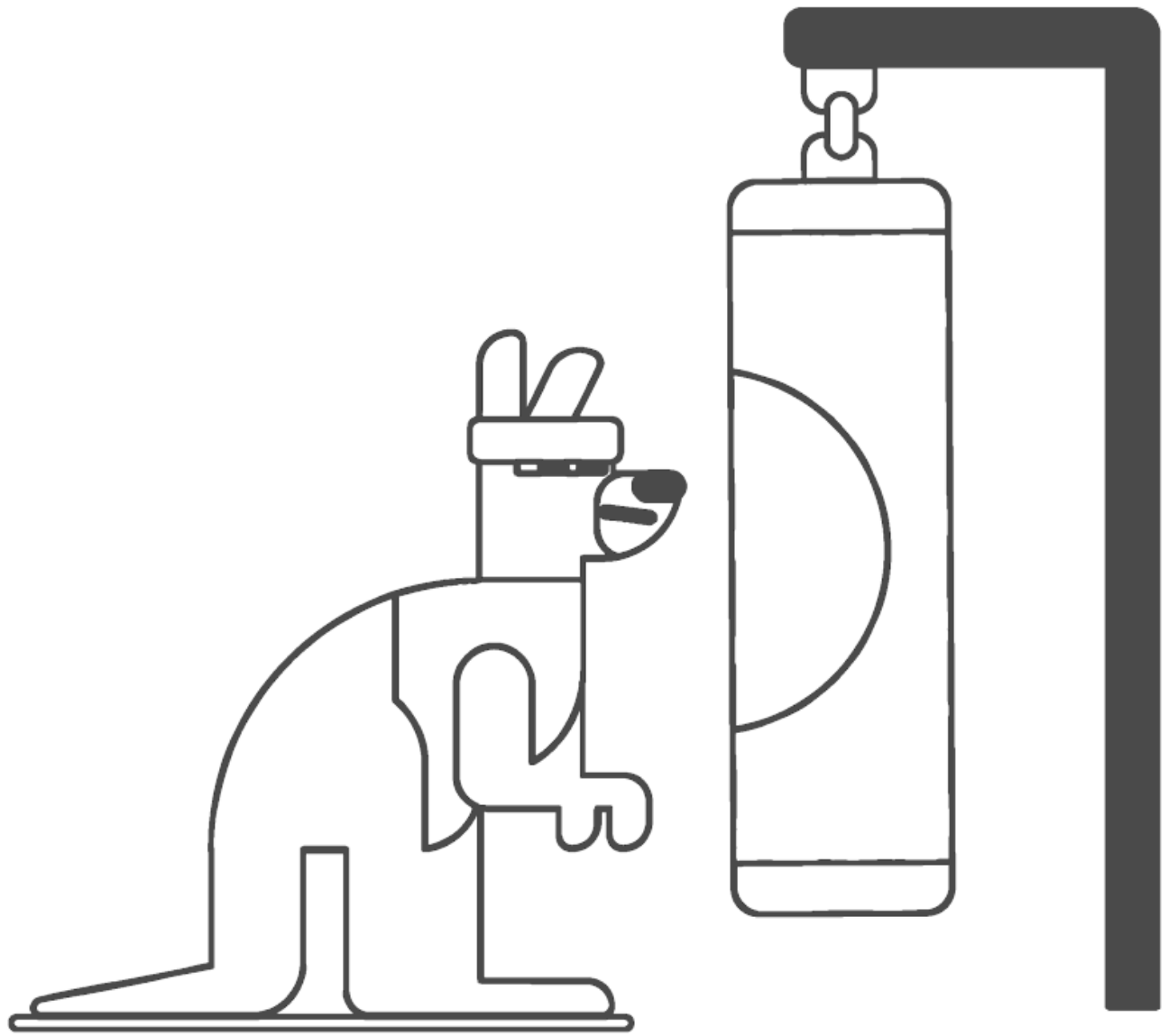

What did Ken do?



A kangaroo kick!

L l

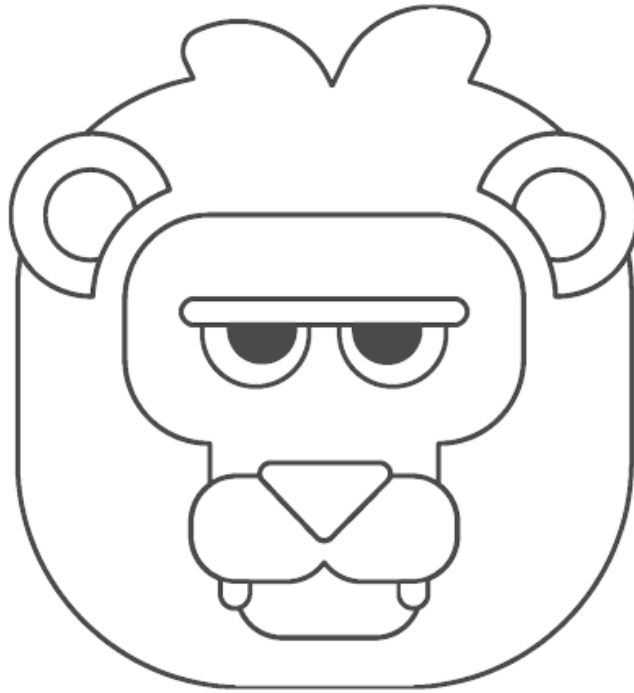

lion

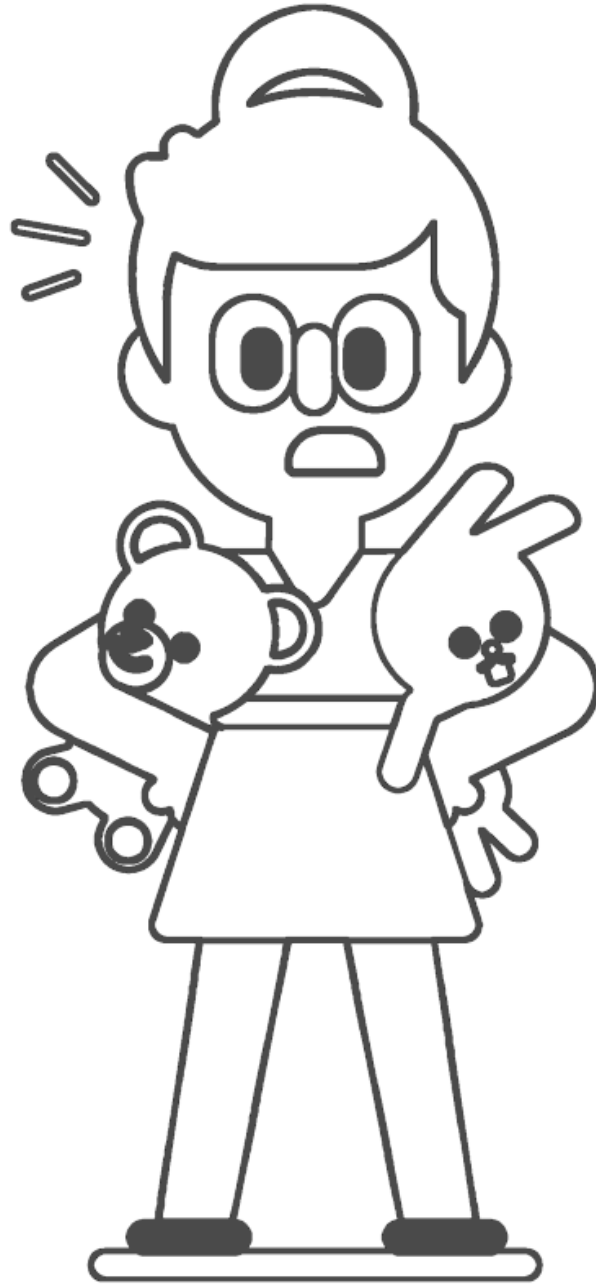

I lost my lion.

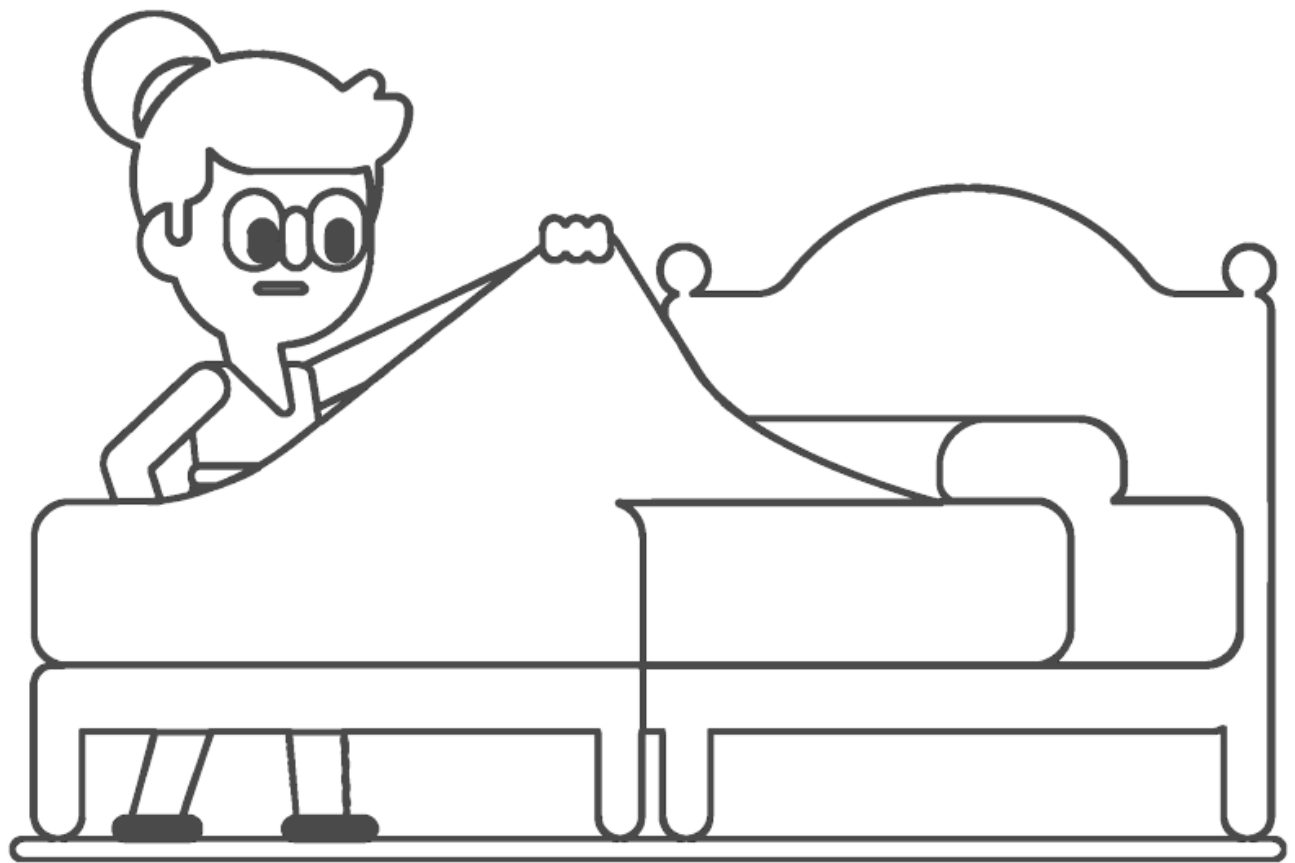

I look in my bed.

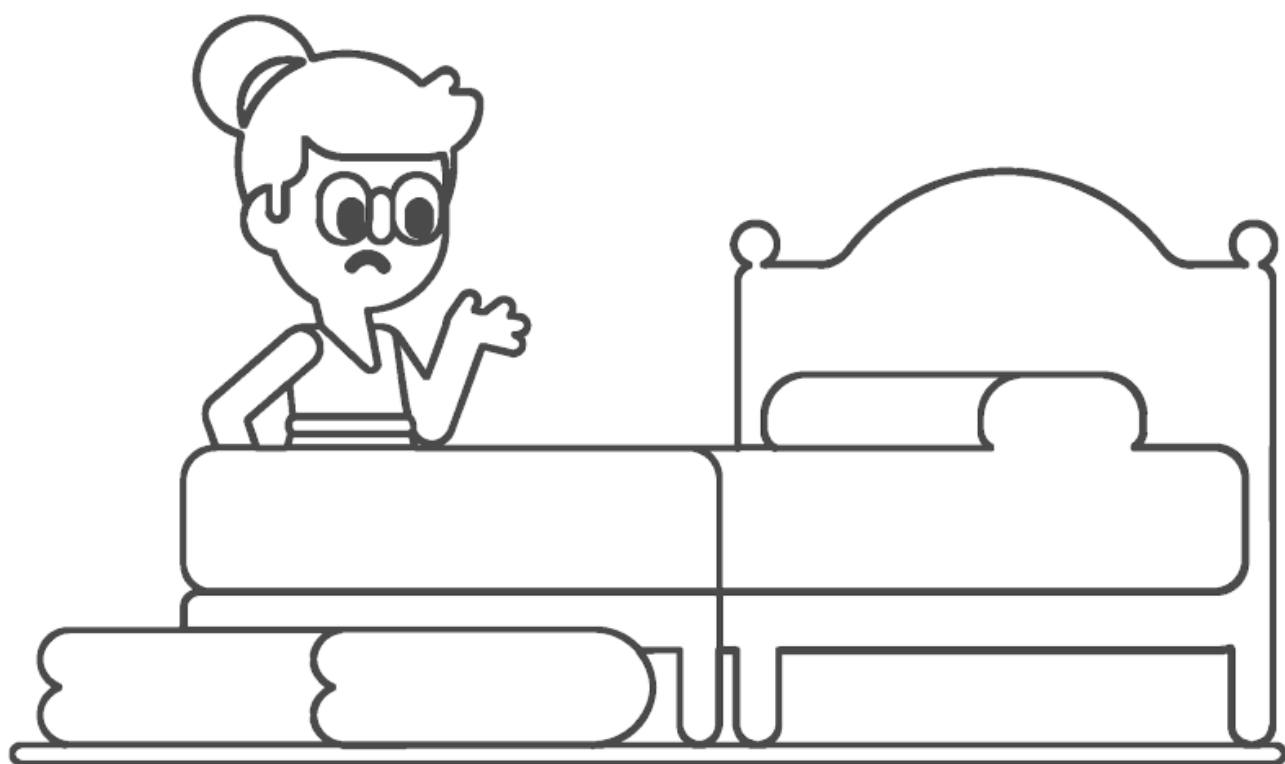

No lion.

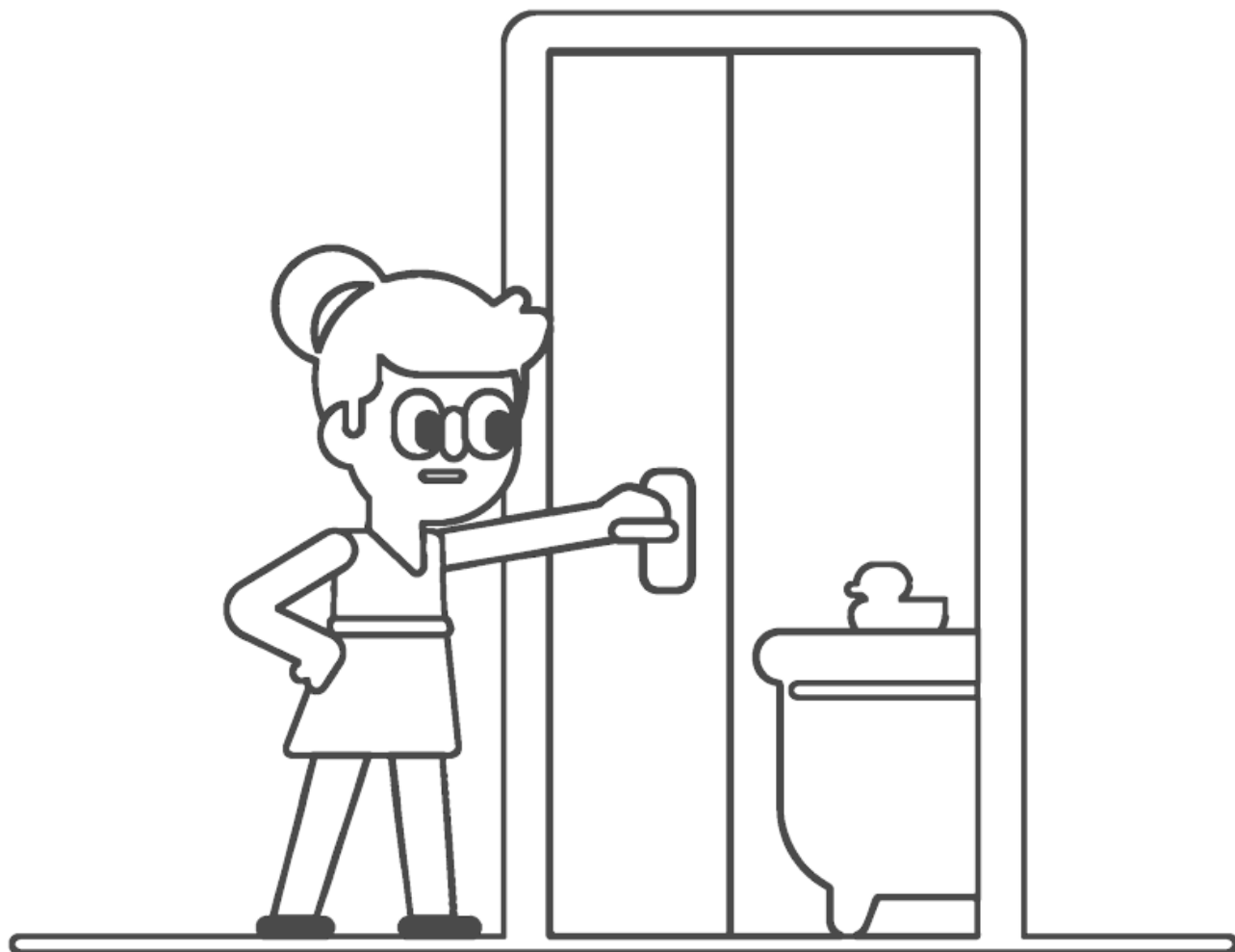

I look in my tub.



No lion.

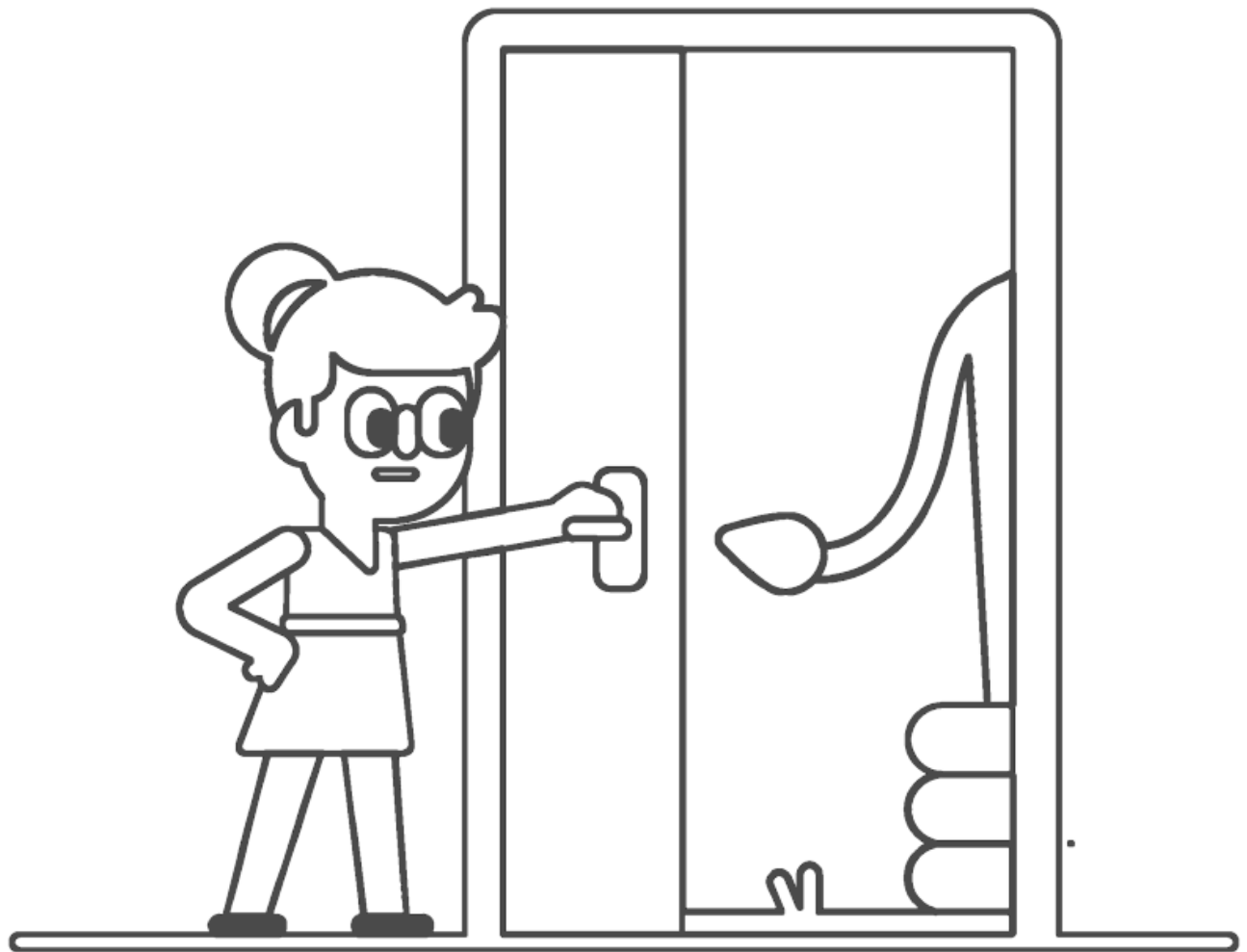

I look in my pool.

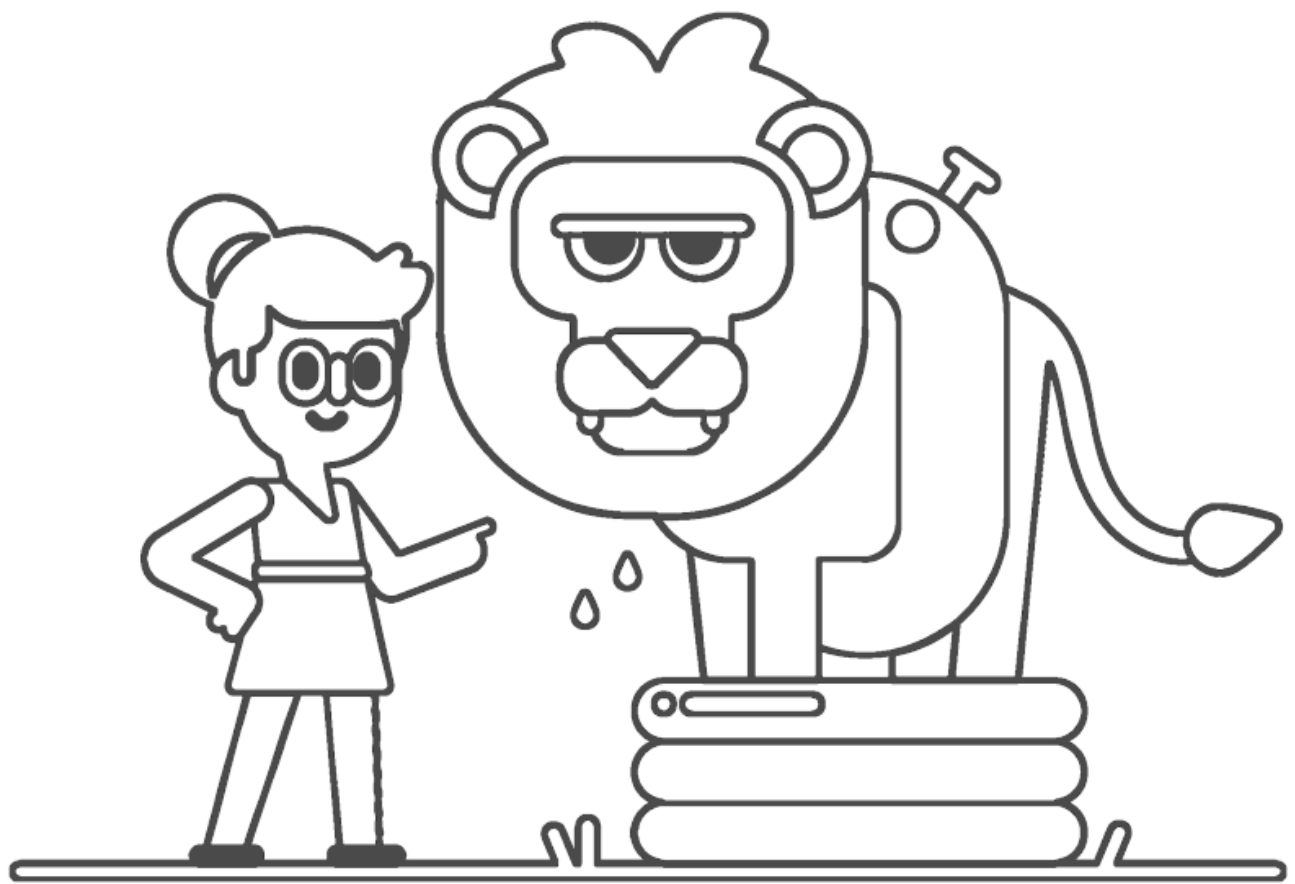

There is my lion!

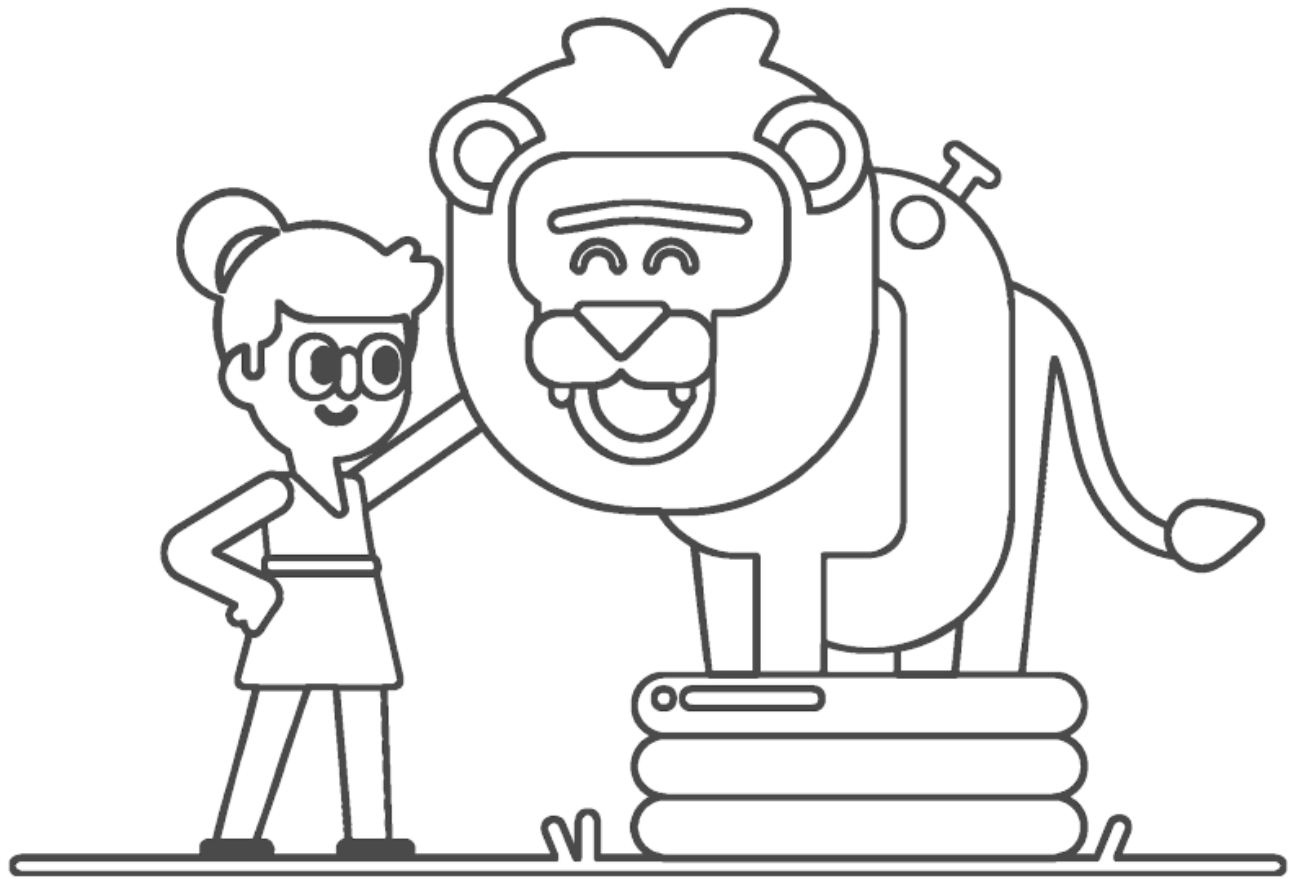

I love my lion.

M m

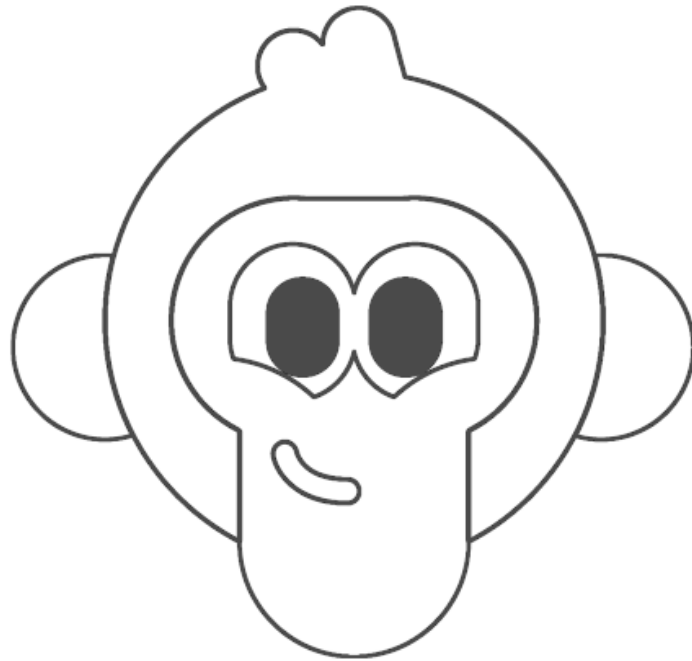

monkey

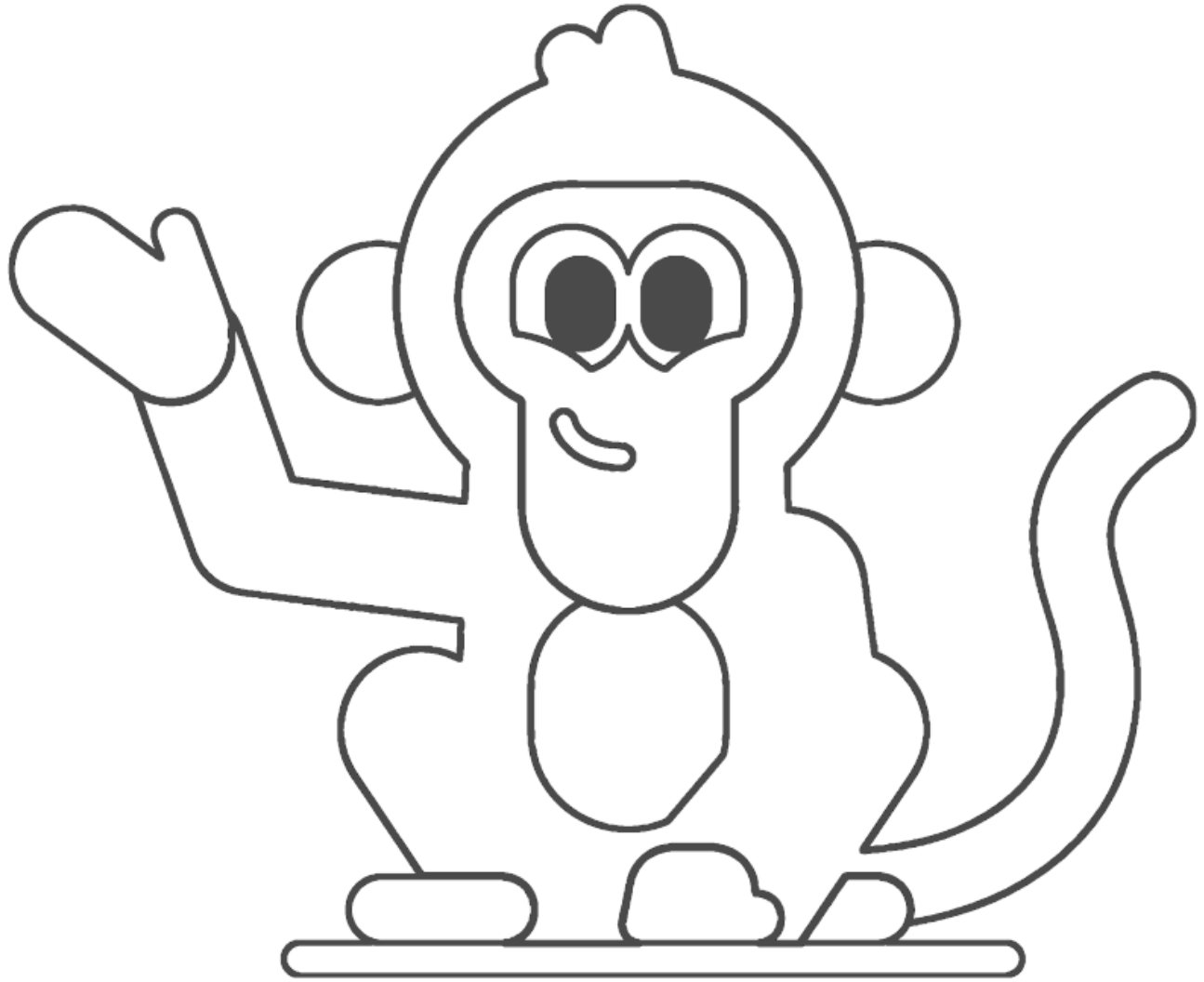

One monkey.

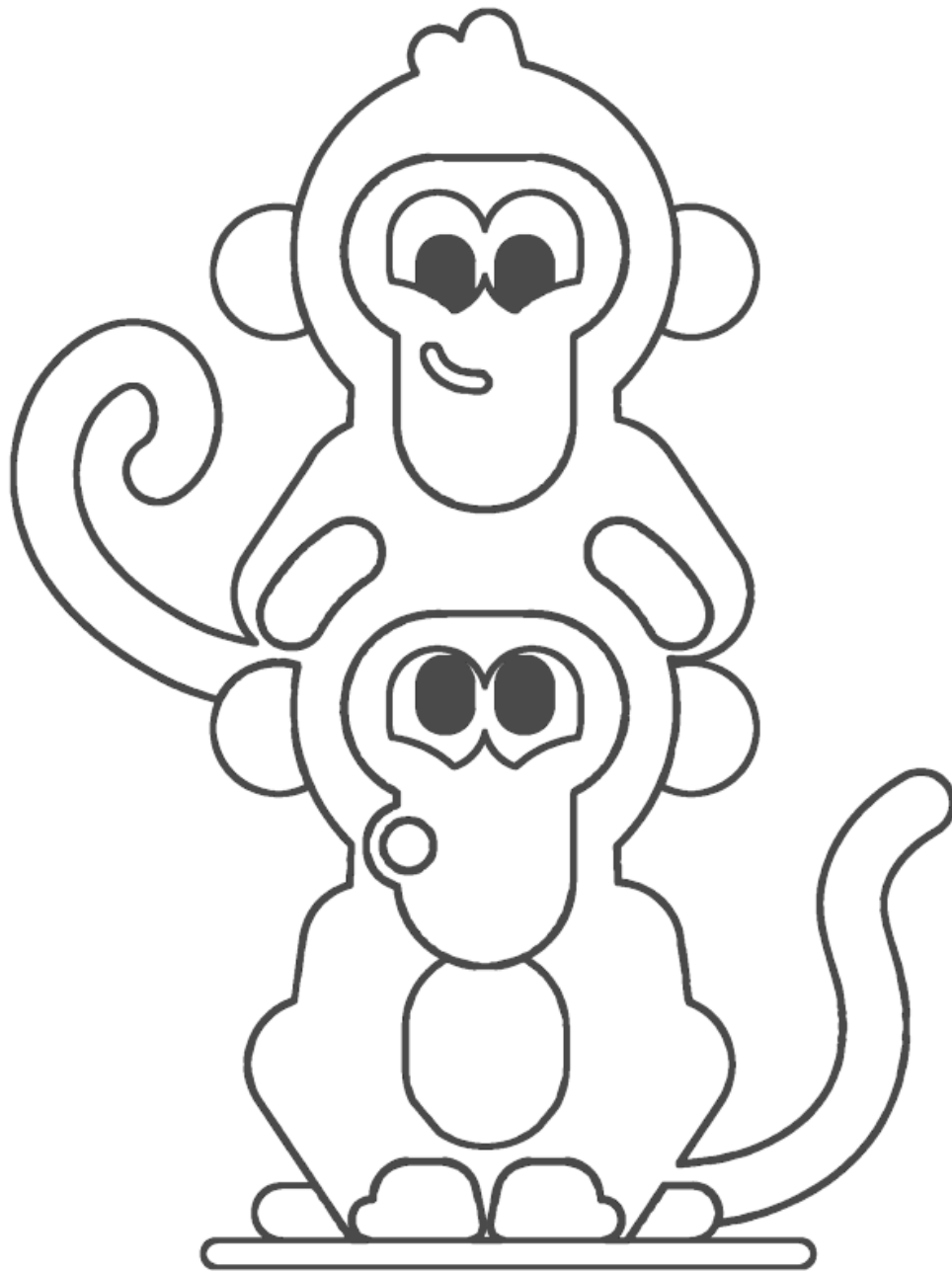

Two monkeys.

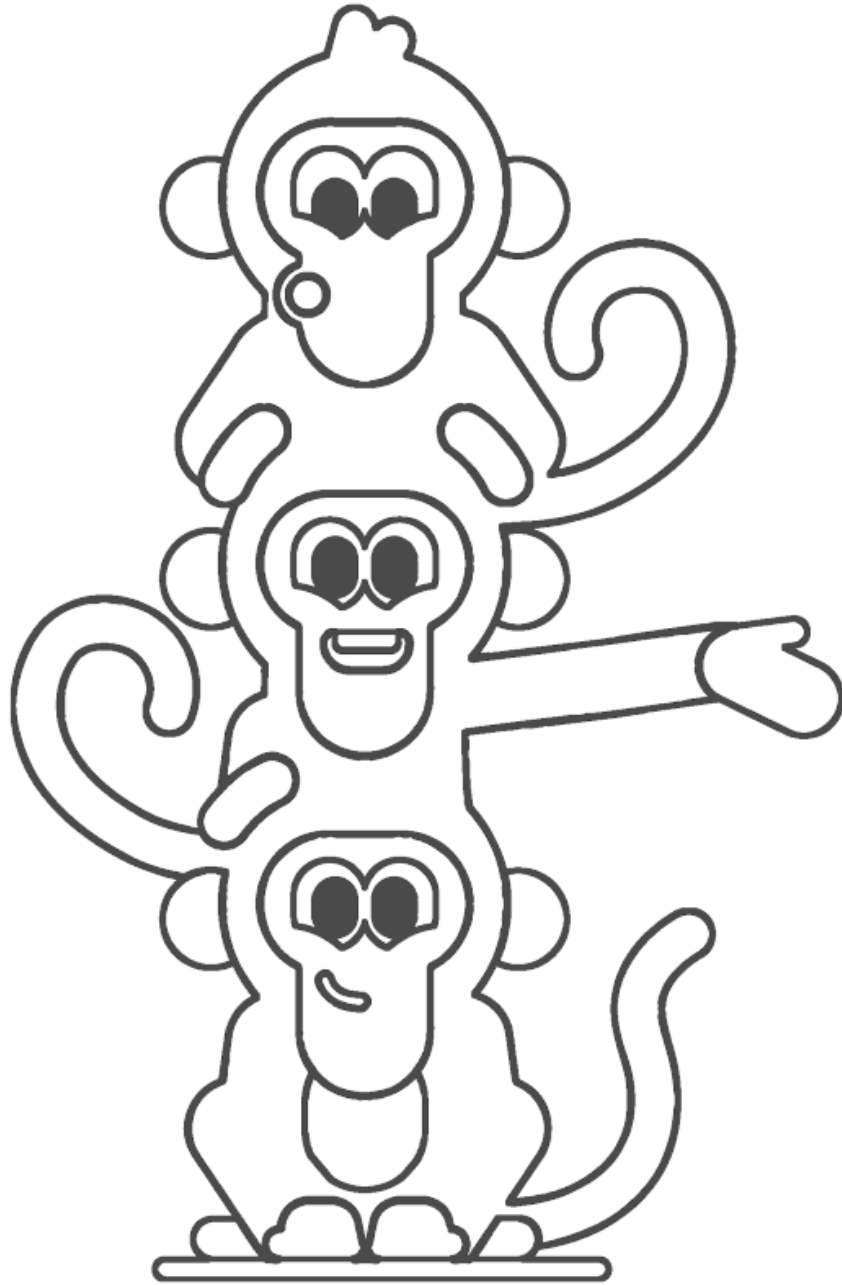

Three monkeys.

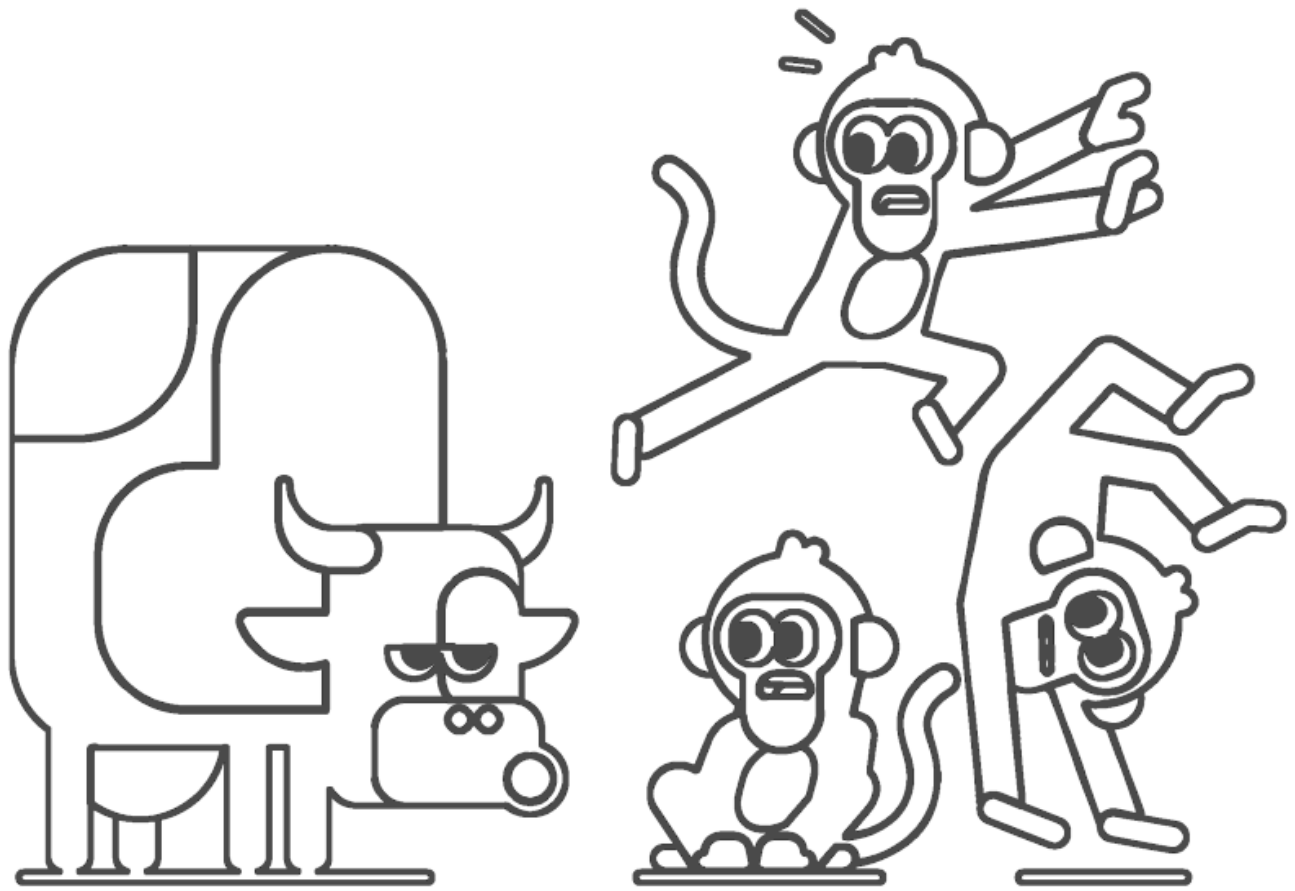

Moo!

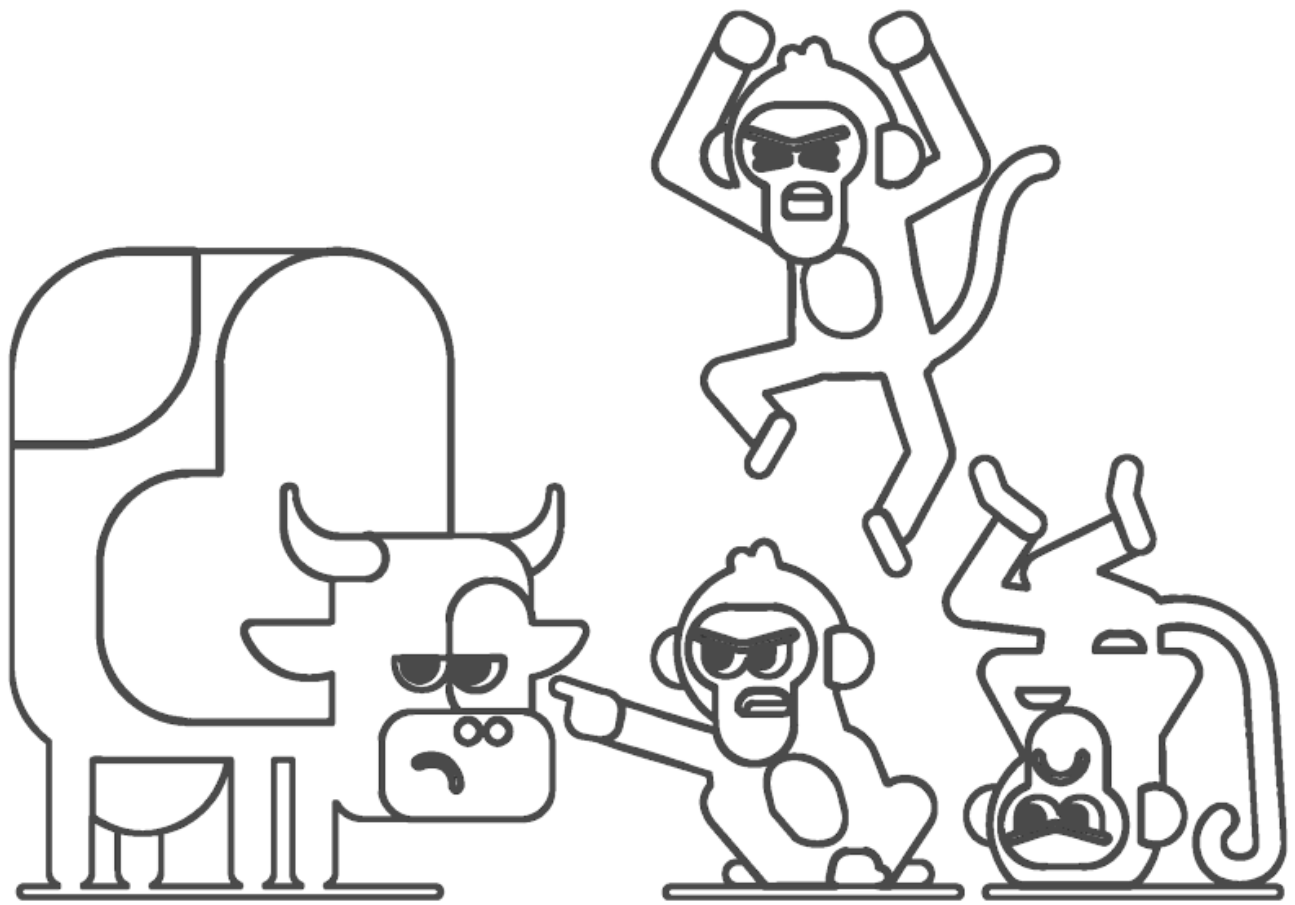

Mad monkeys.

N n

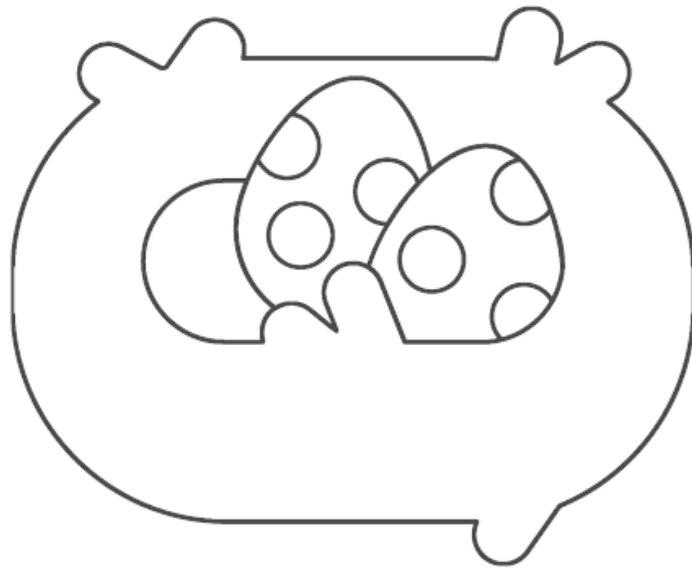

nest

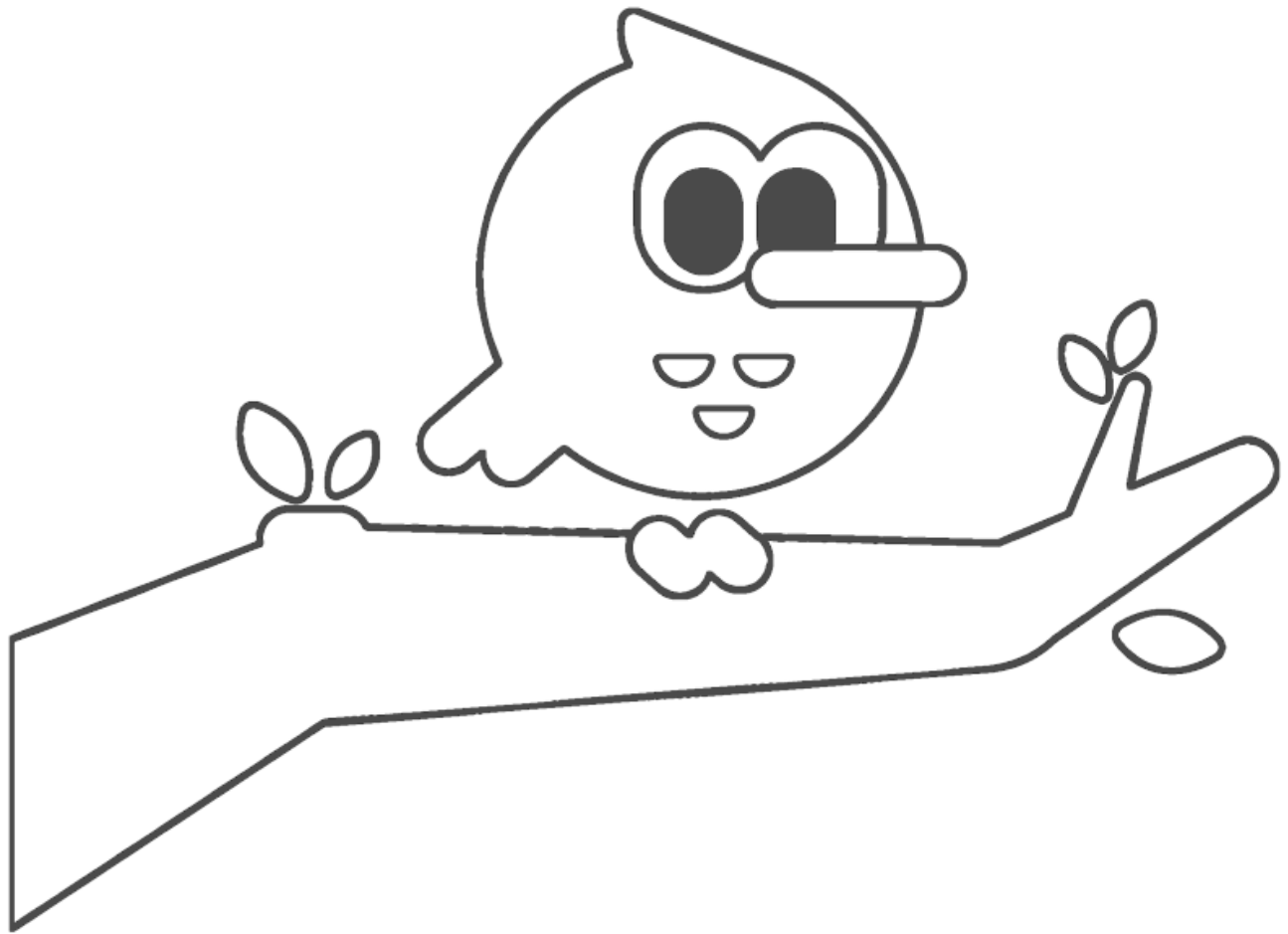

I have a nice home.



It is not a house.

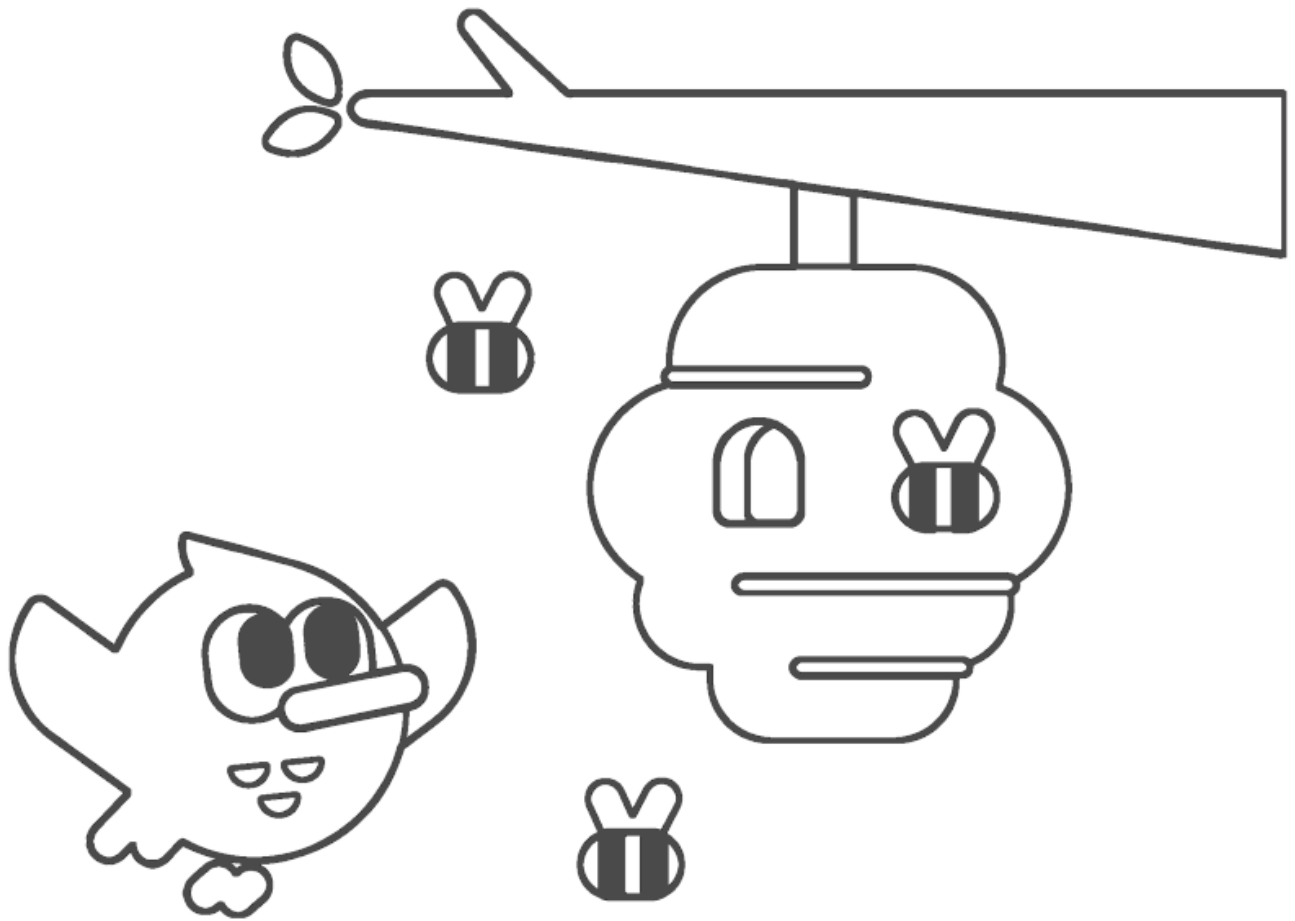

It is not a hive.

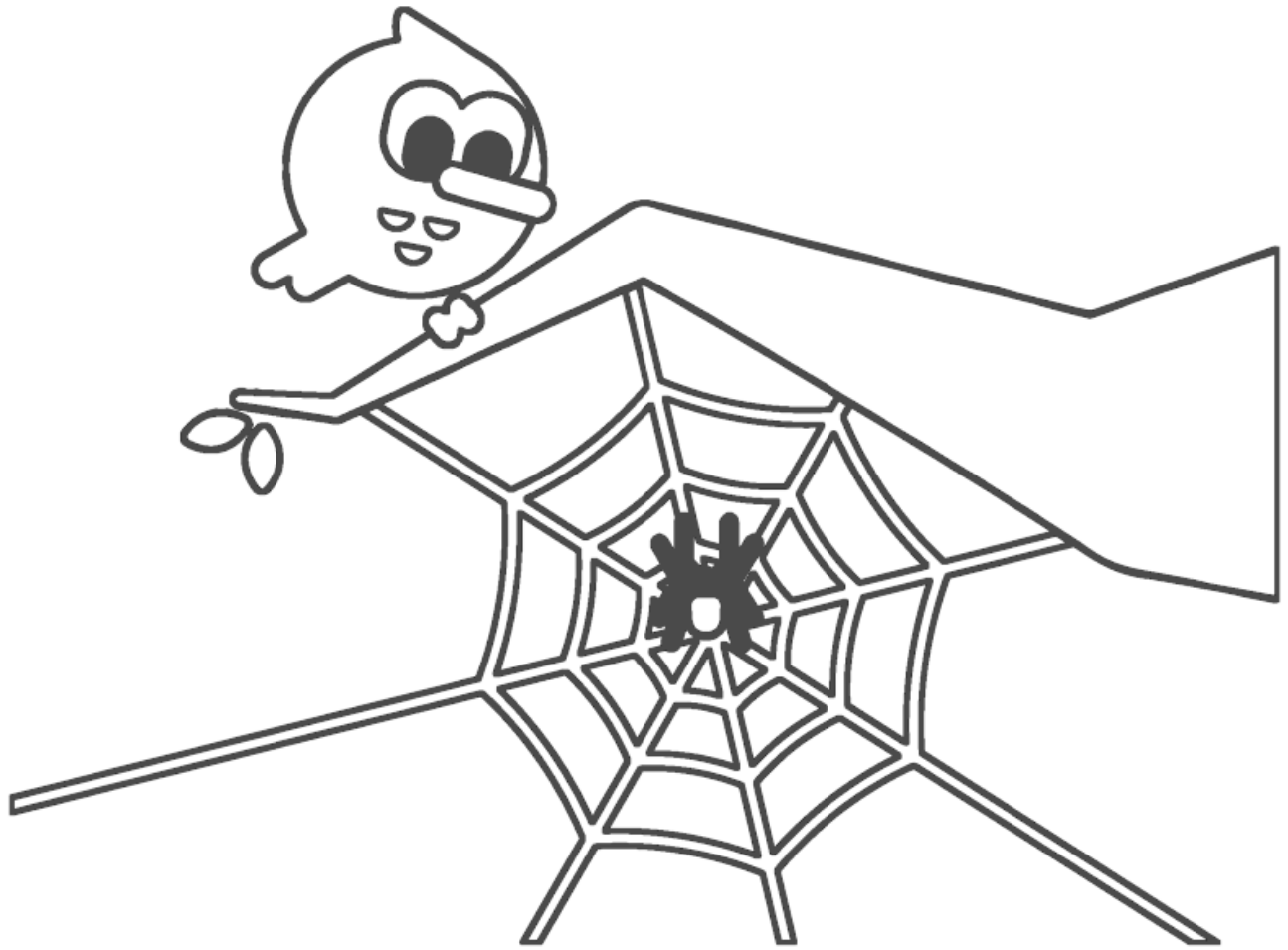

It is not a web.

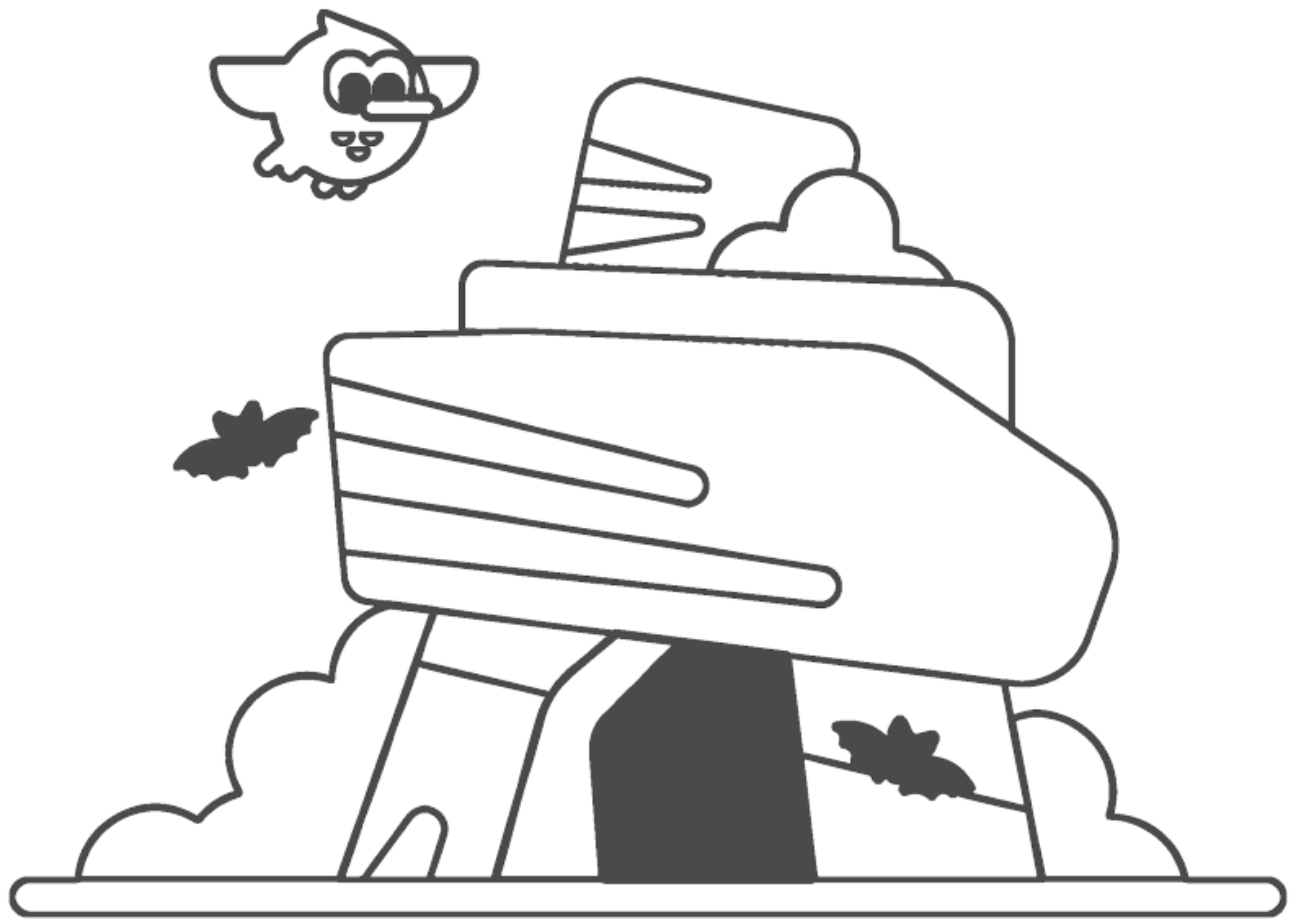

It is not a cave.

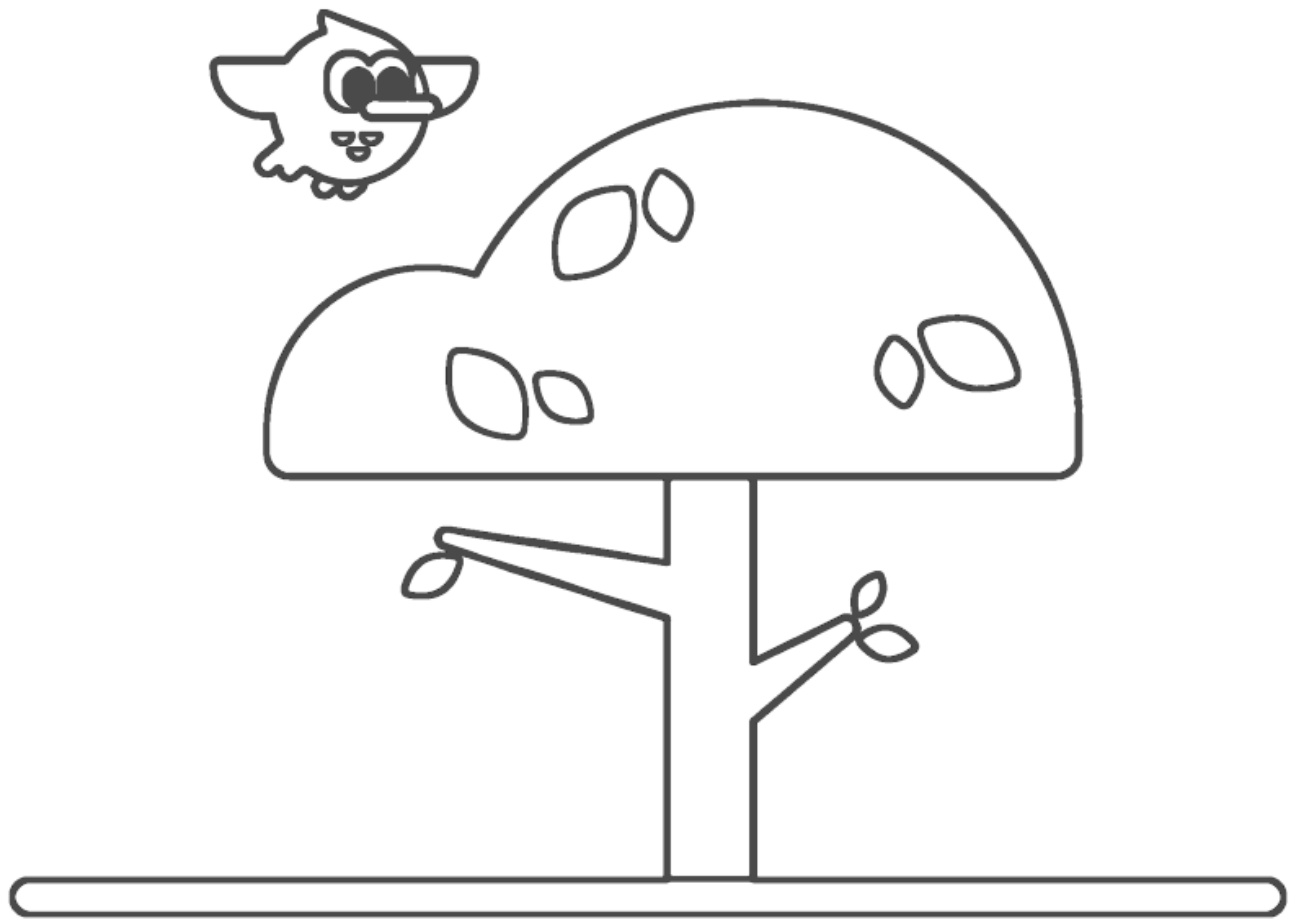

I have a nice home.

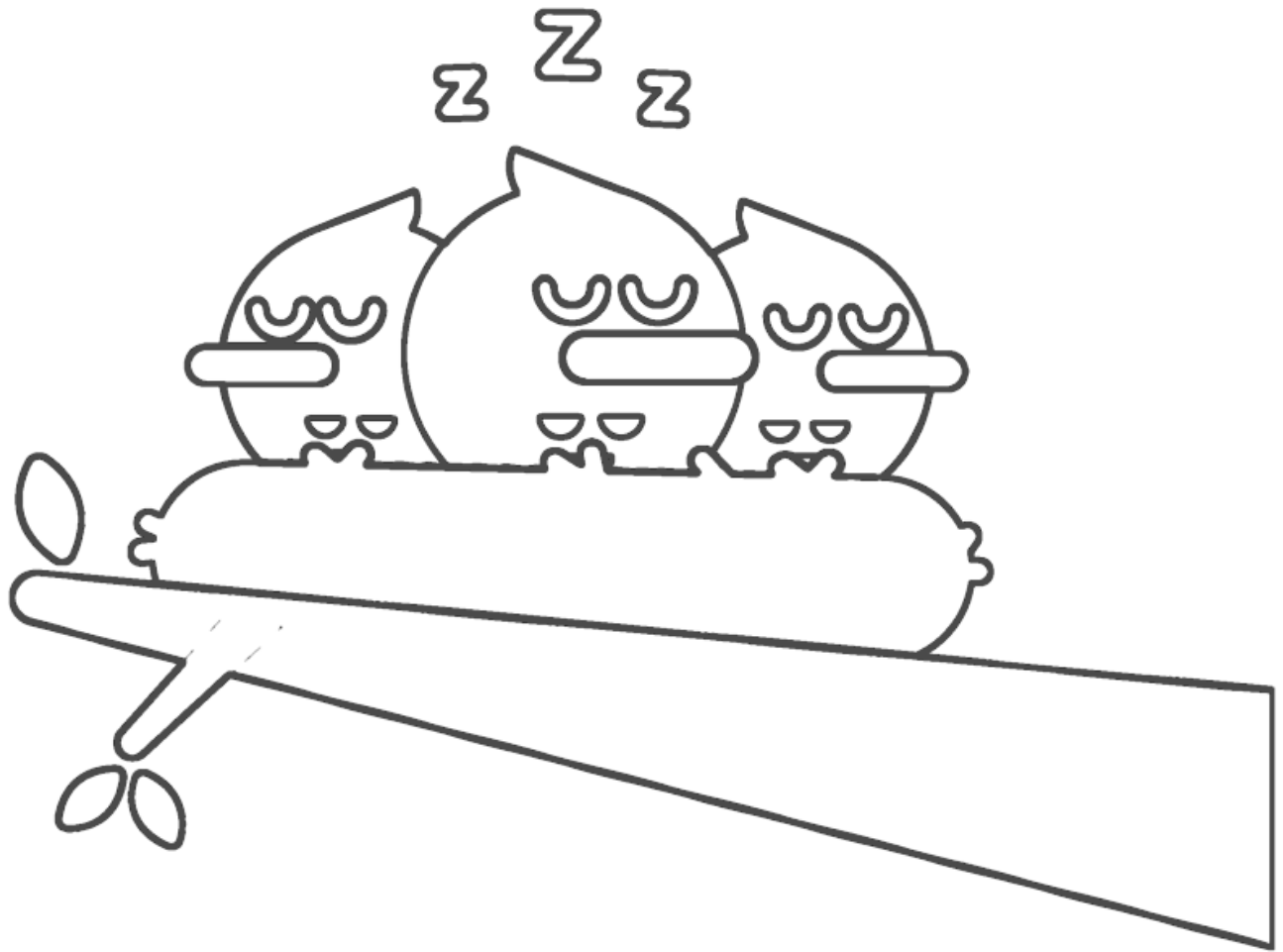

My home is a nest.

O o

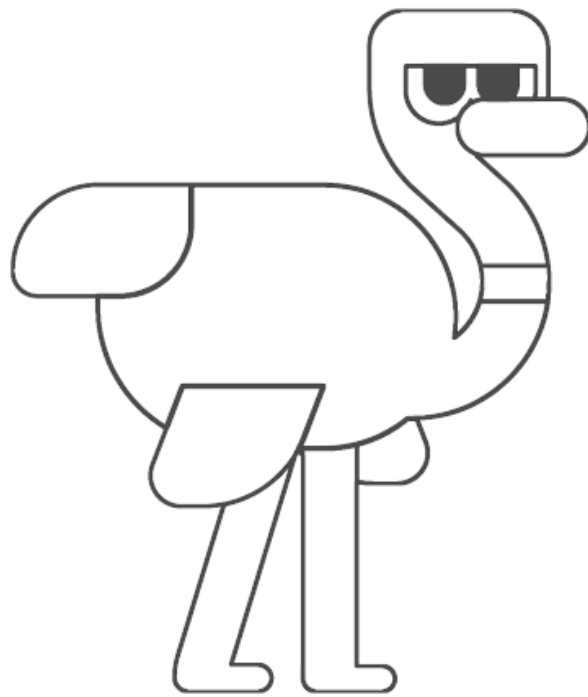

ostrich

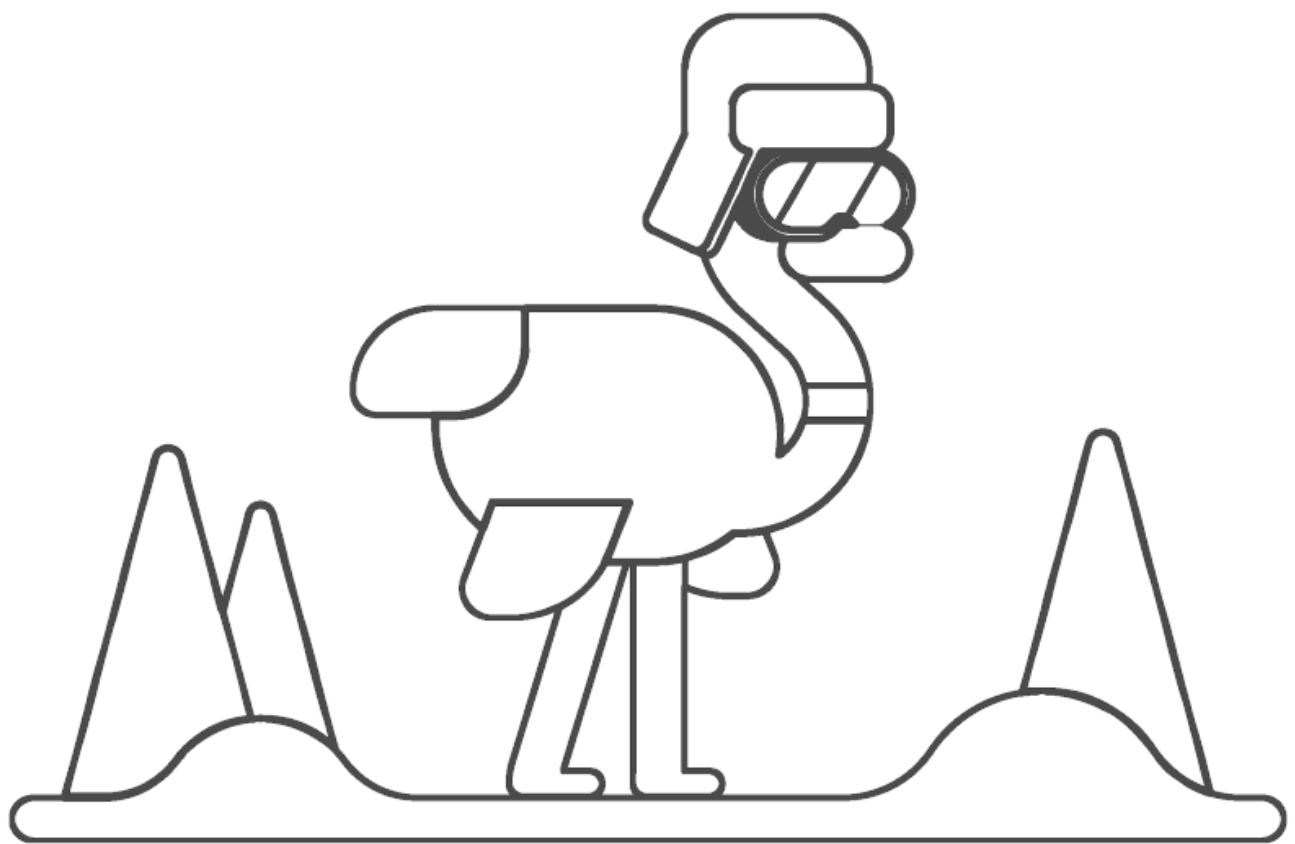

My hat is on.

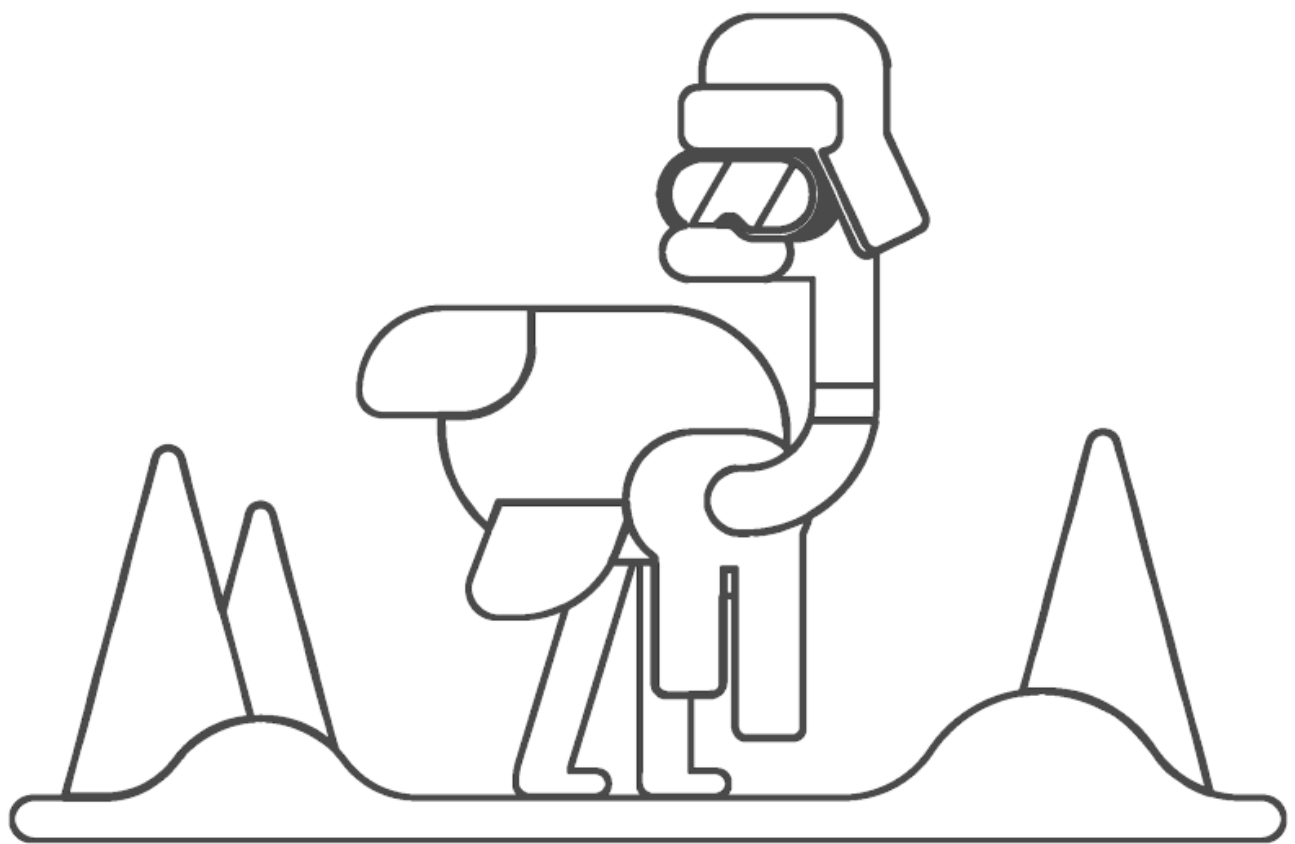

My scarf is on.

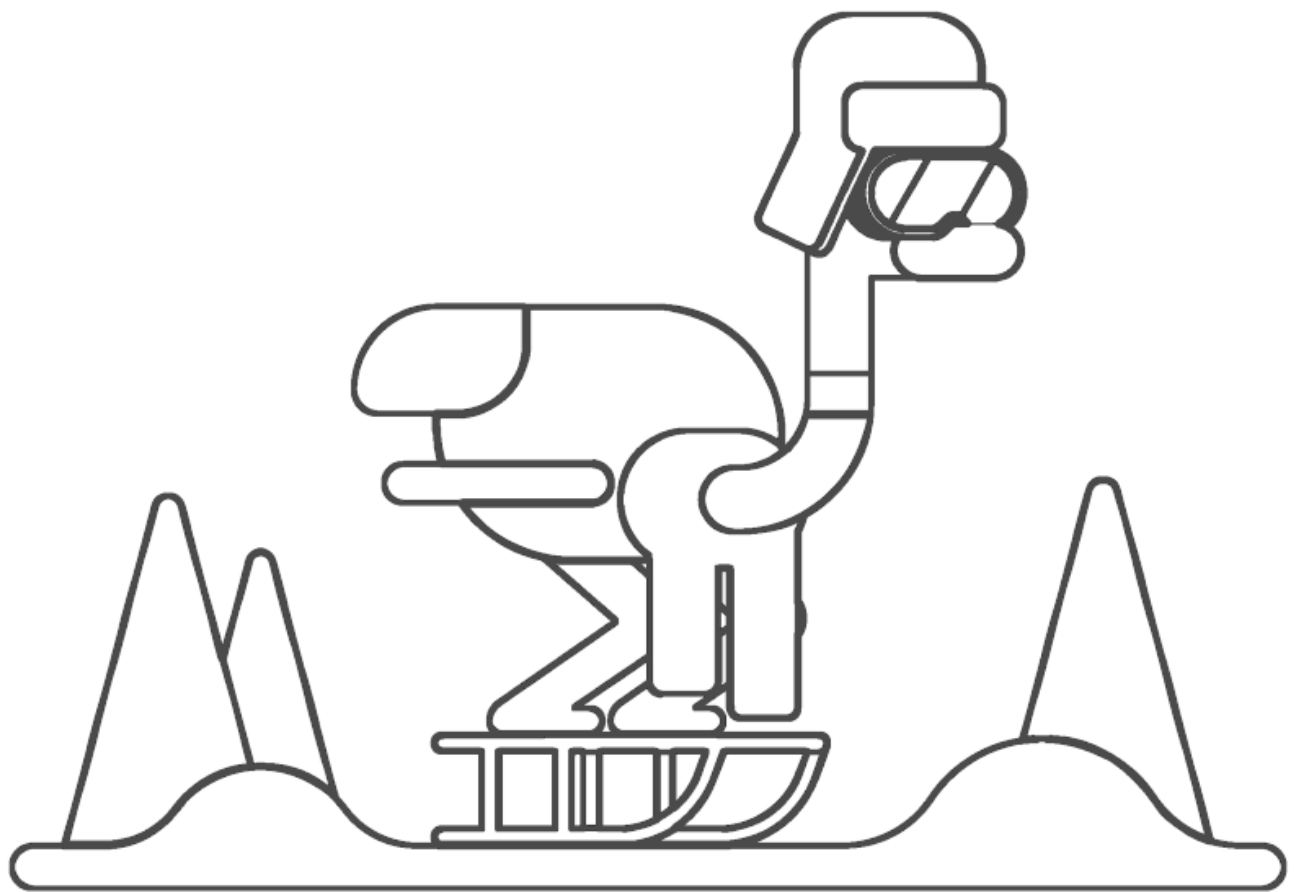

I am on the sled.

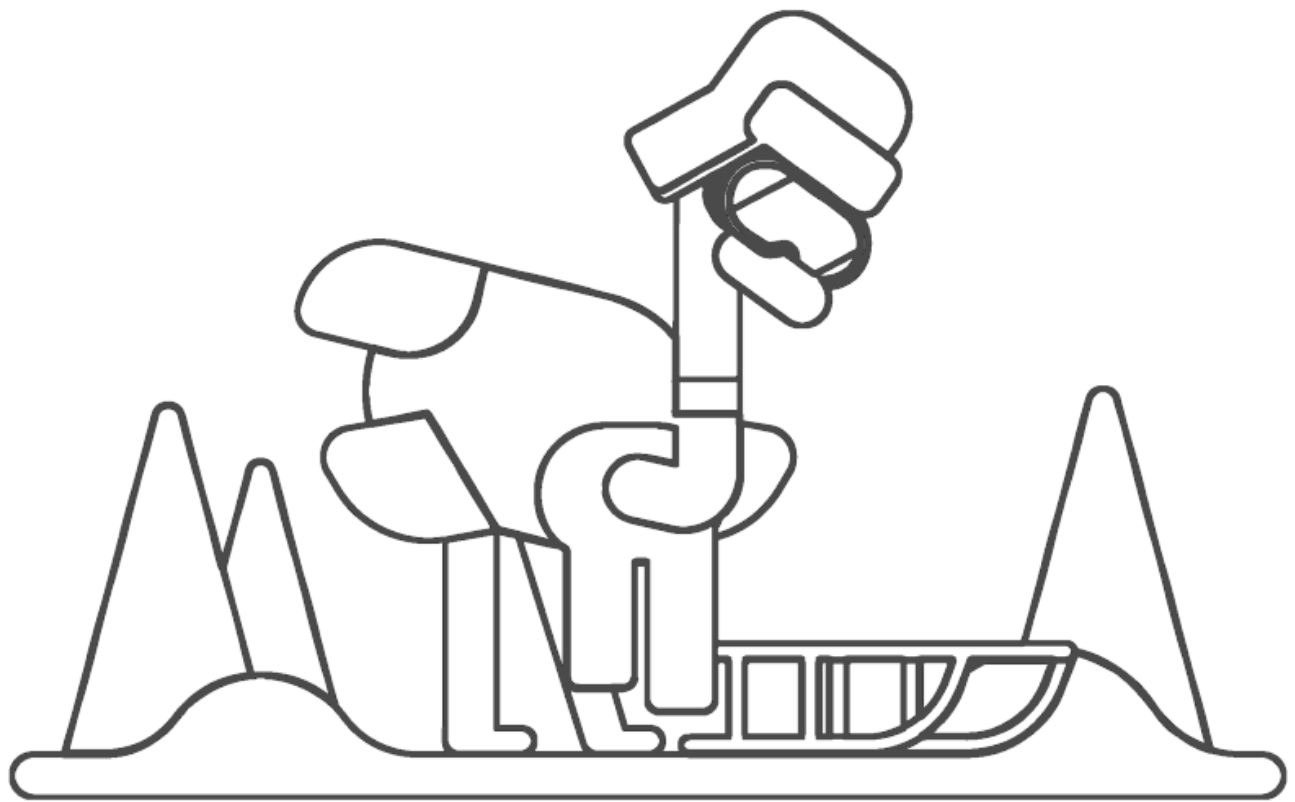

I am off the sled.

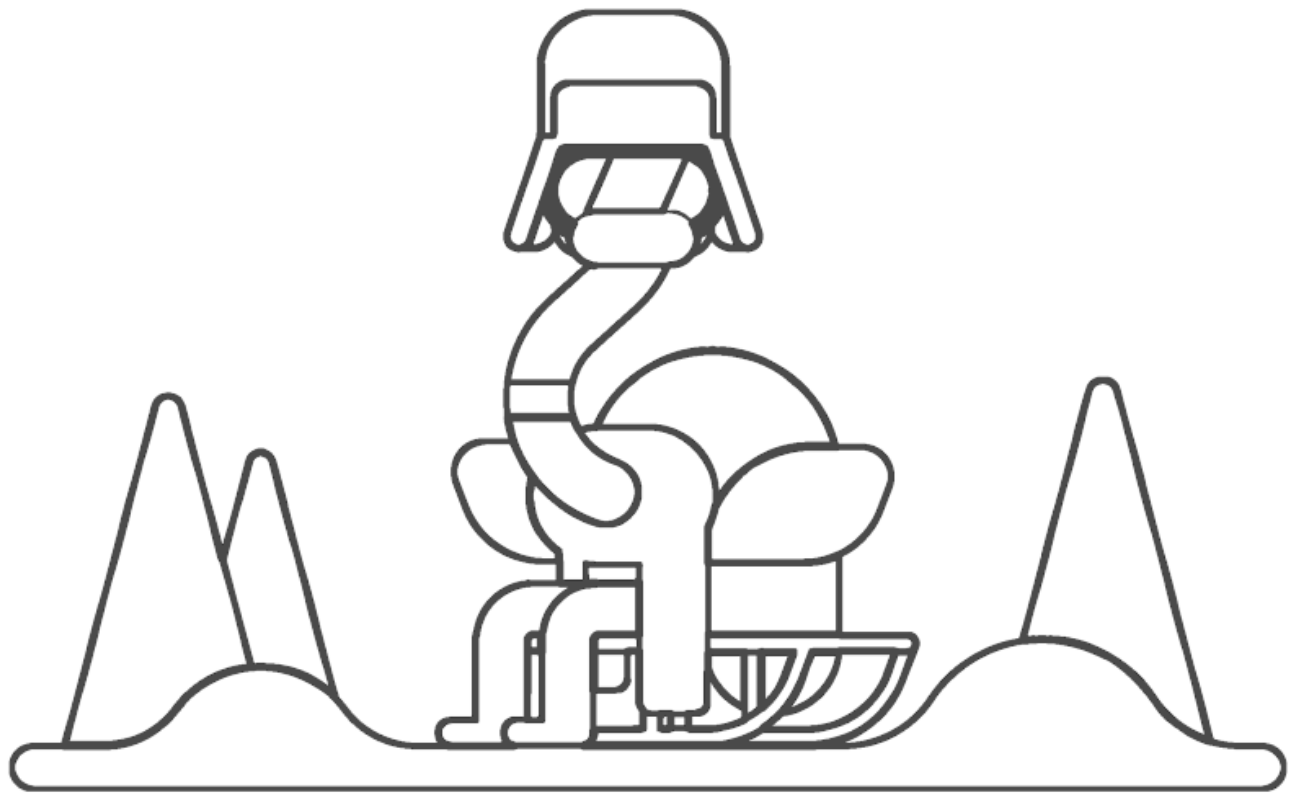

Am I on the sled?

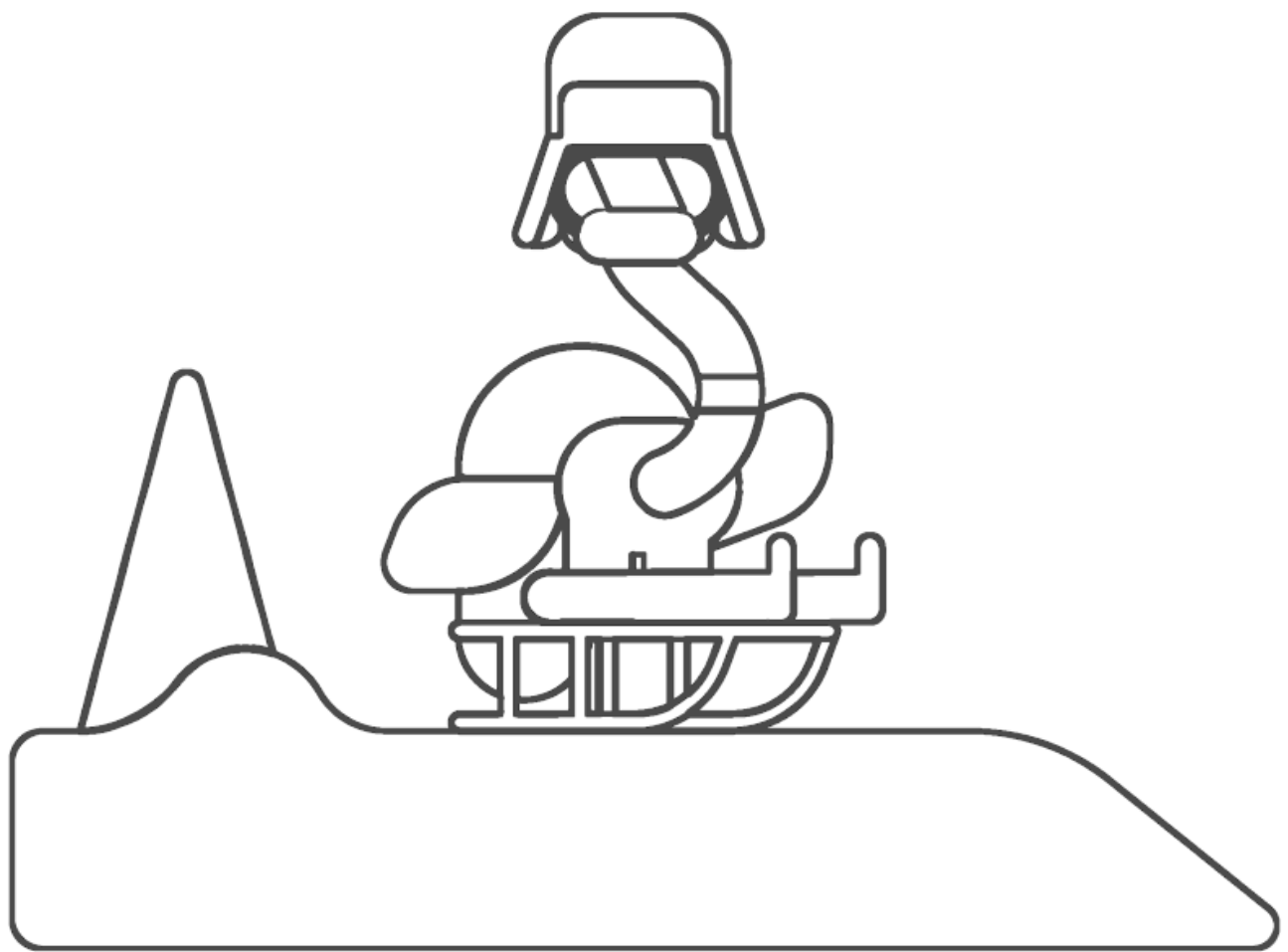

I am on the sled!

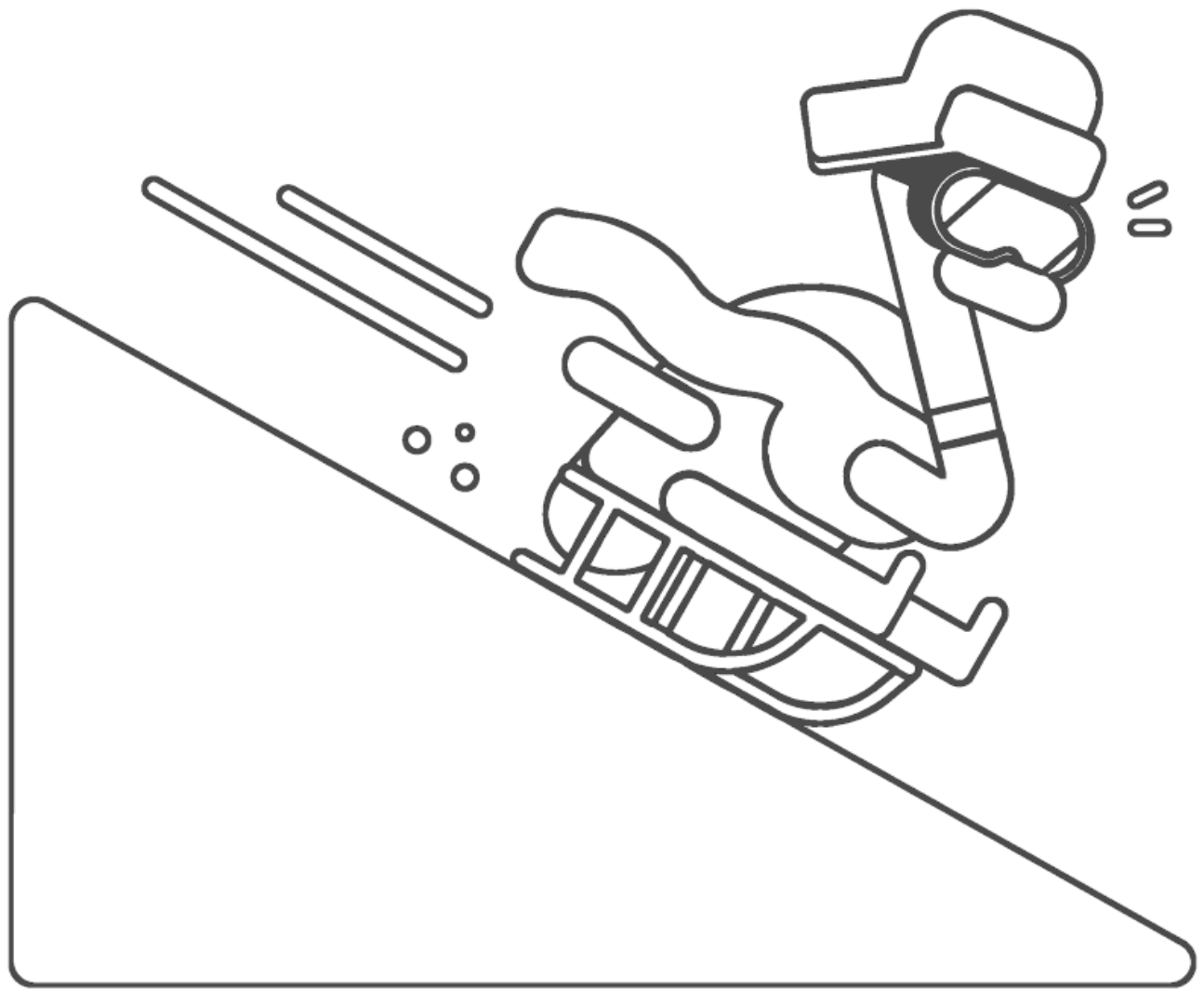

Hold on!

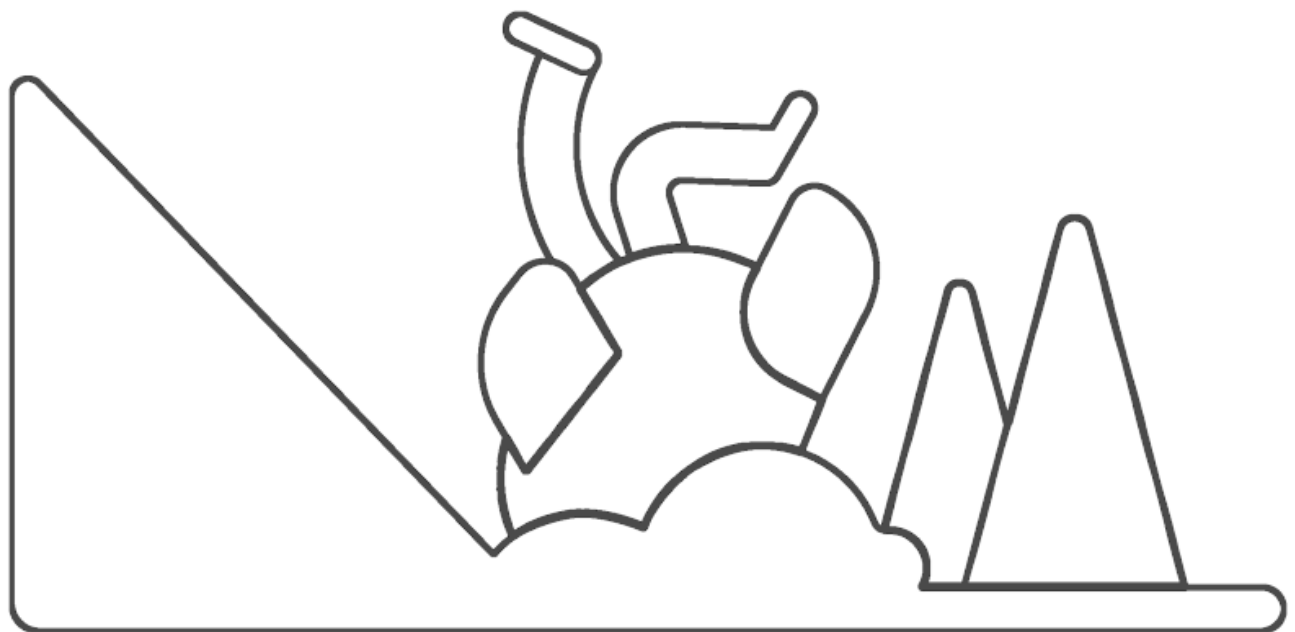

And I'm off the sled!

P p

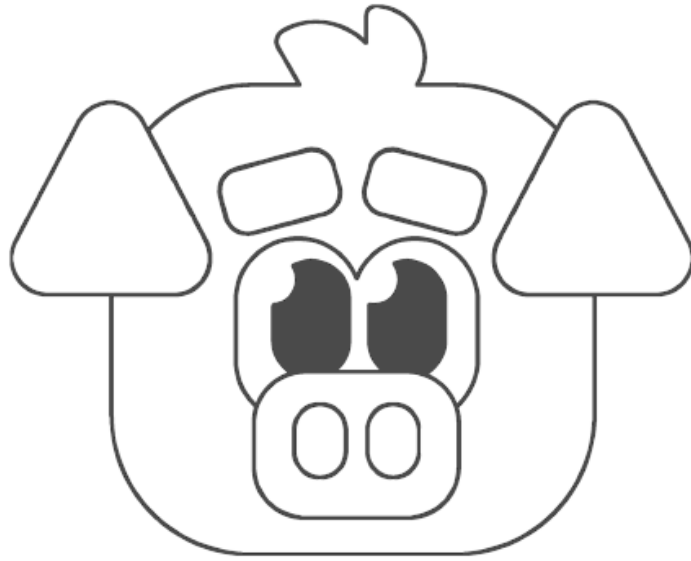

pig

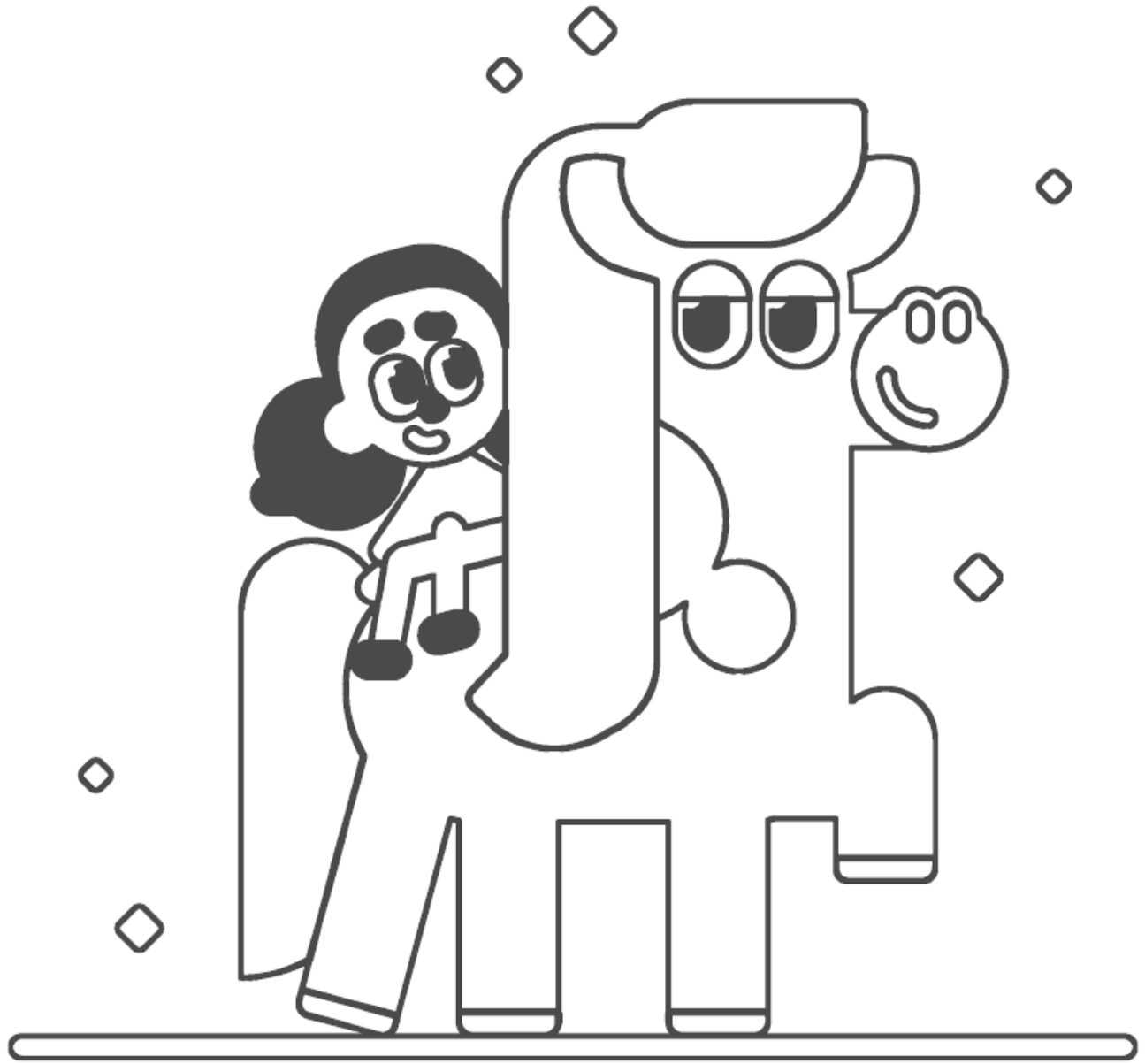

My pony is pink.

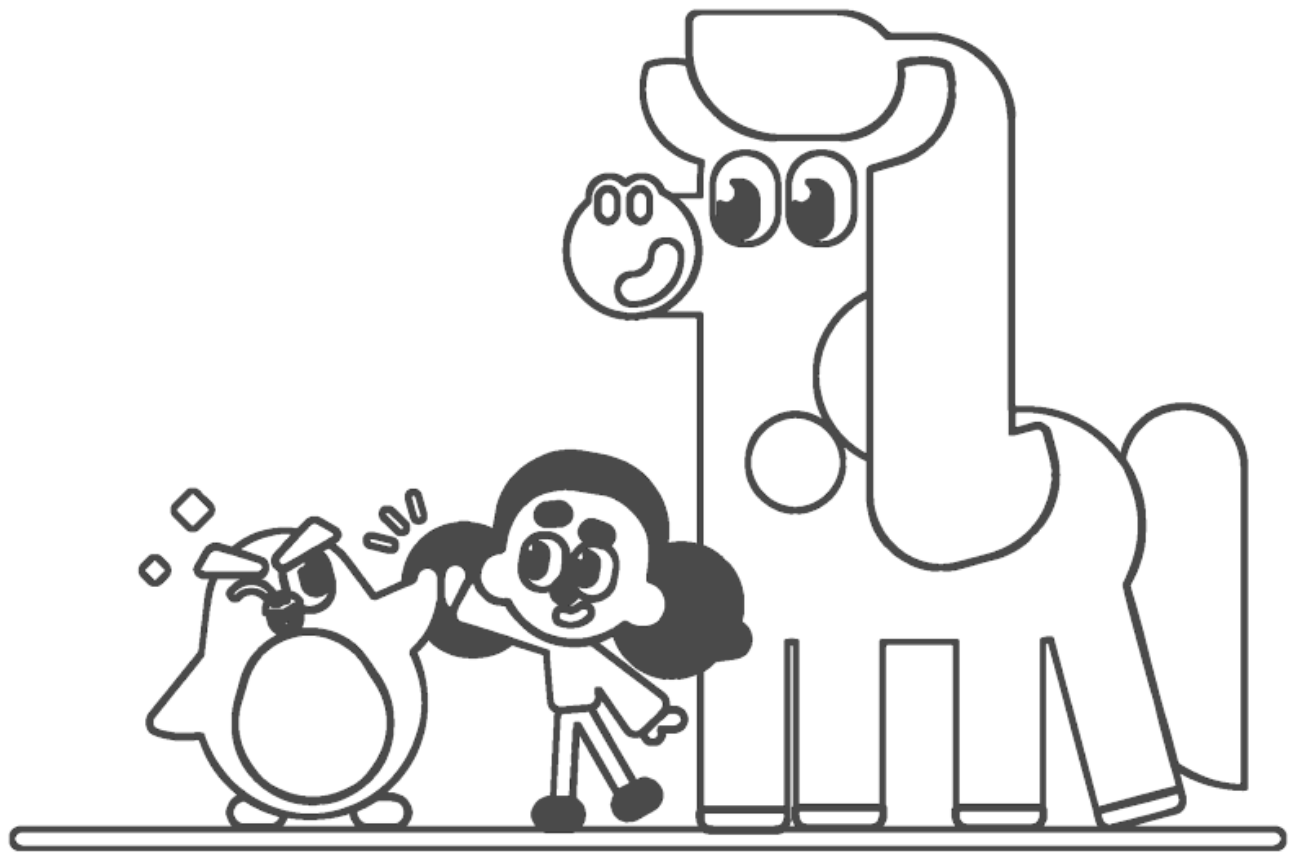

My penguin is pink.

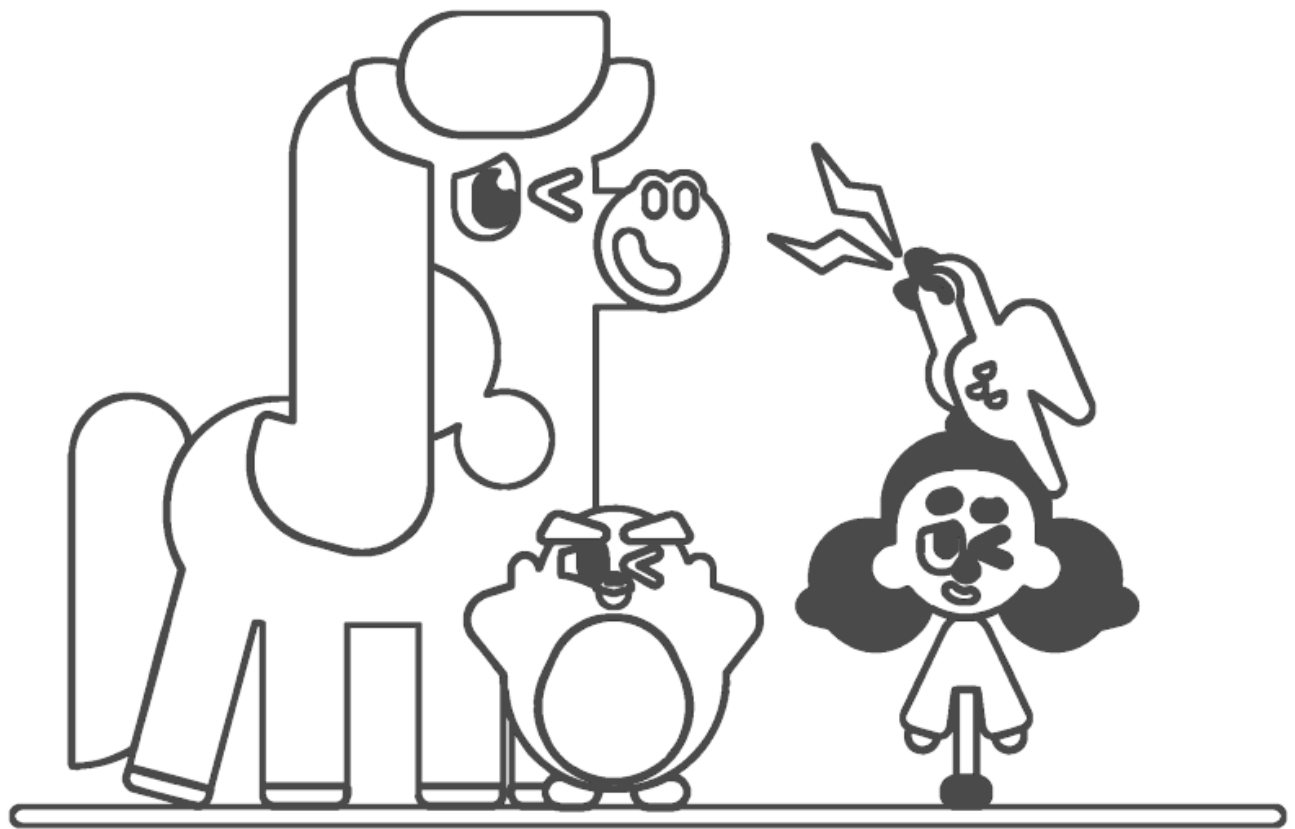

My parrot is pink.

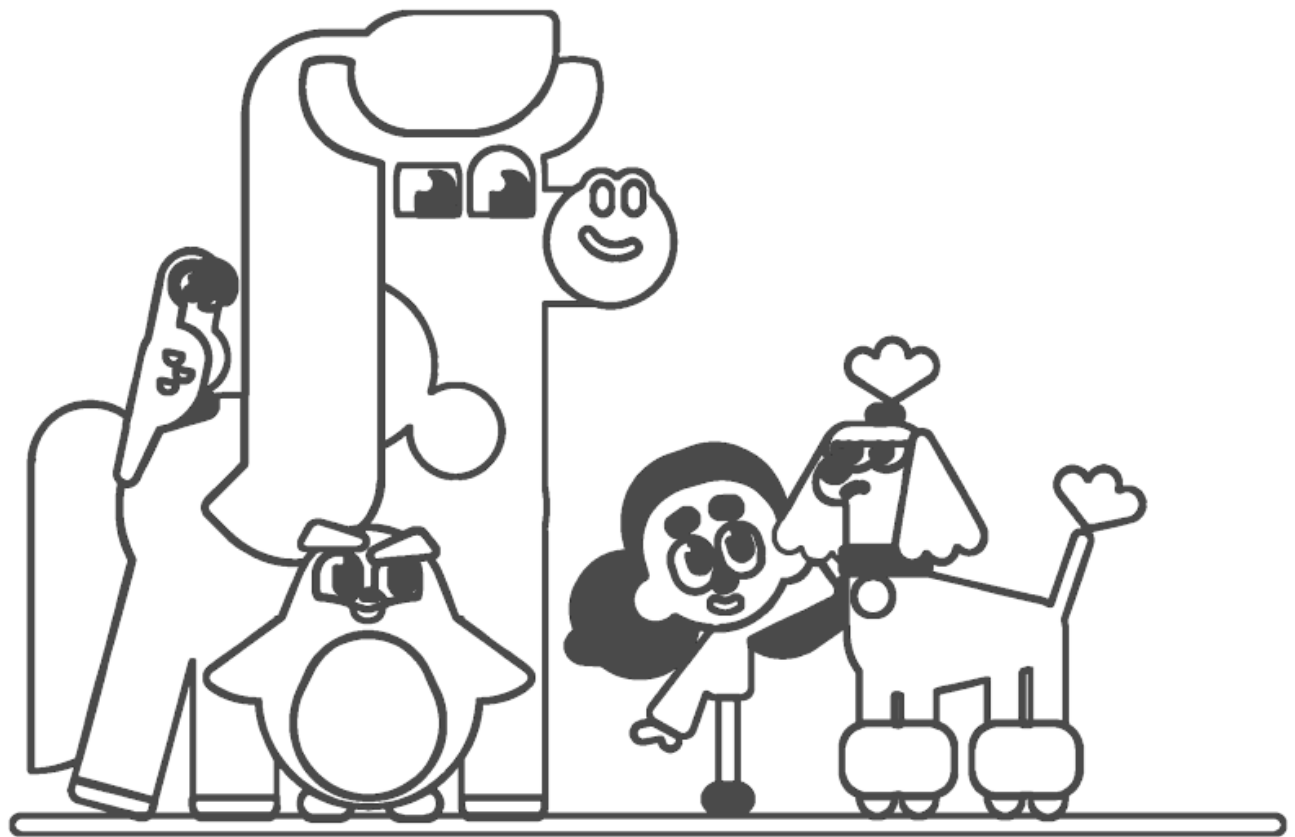

My poodle is pink.

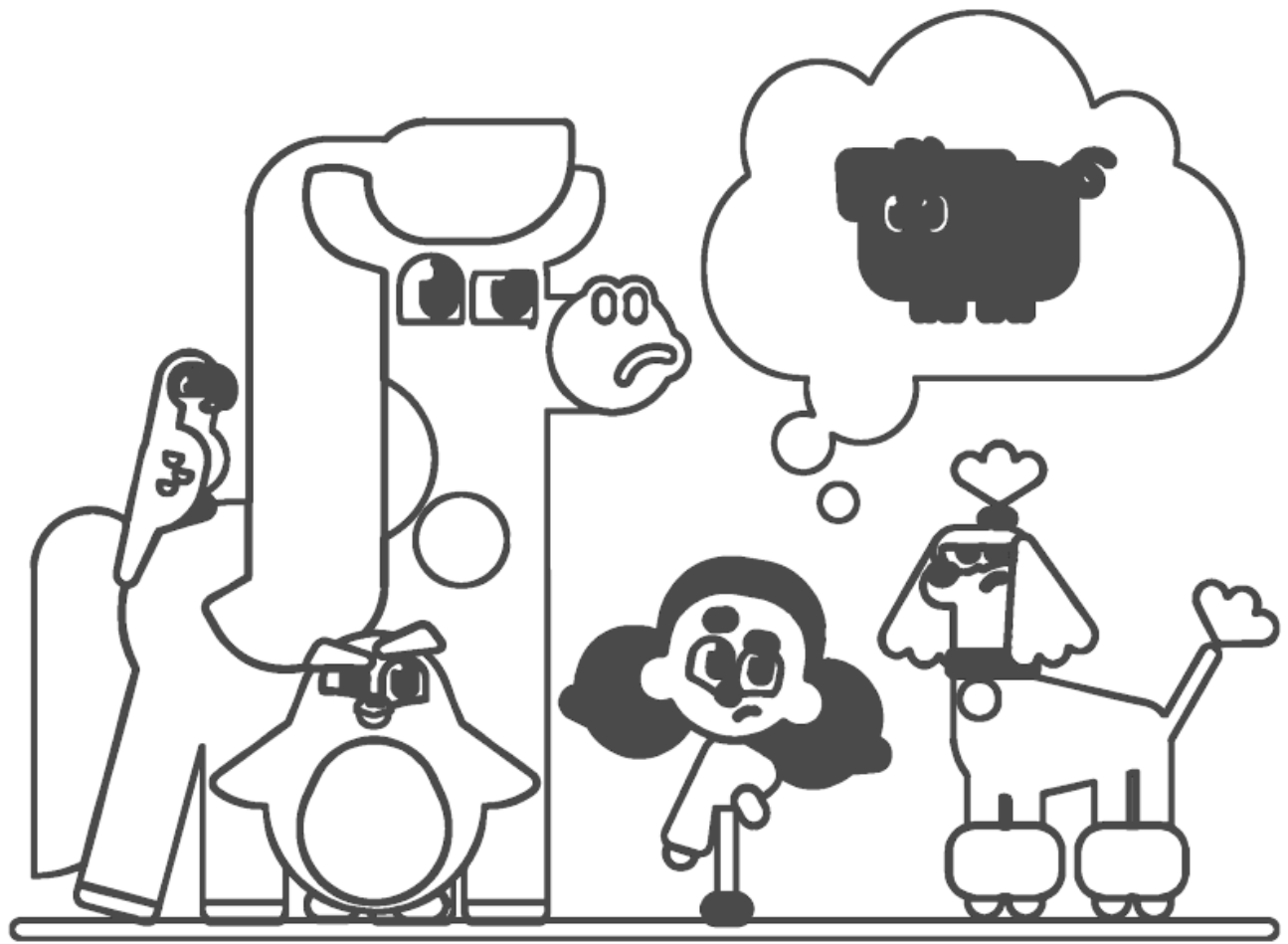

What color is my pig?

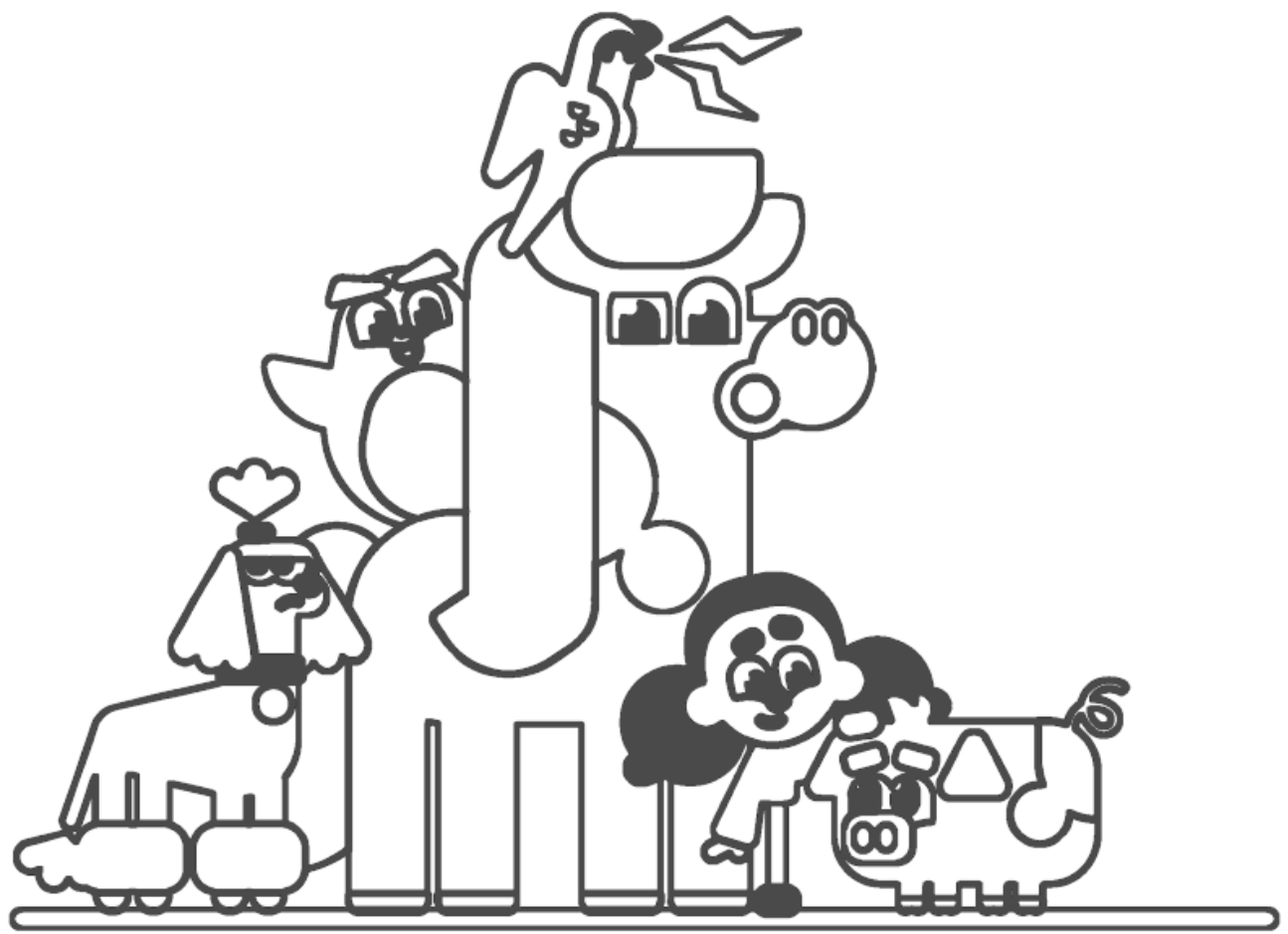

It's purple, I think!

Q q

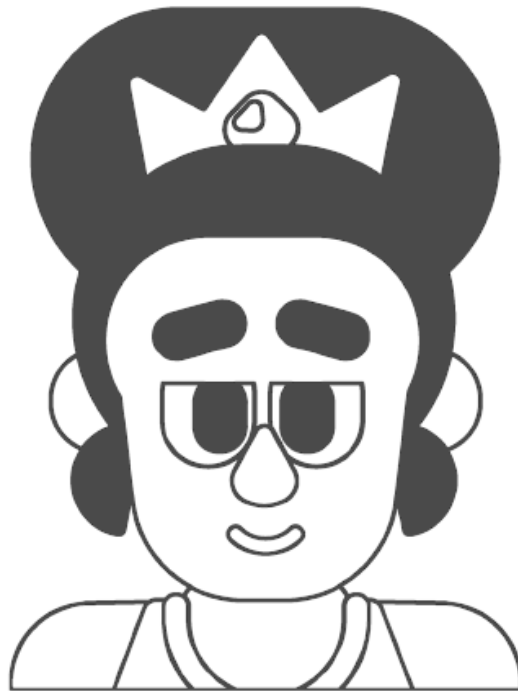

queen



"Quack!" said the duck.



**"Be quiet!" said the
queen.**

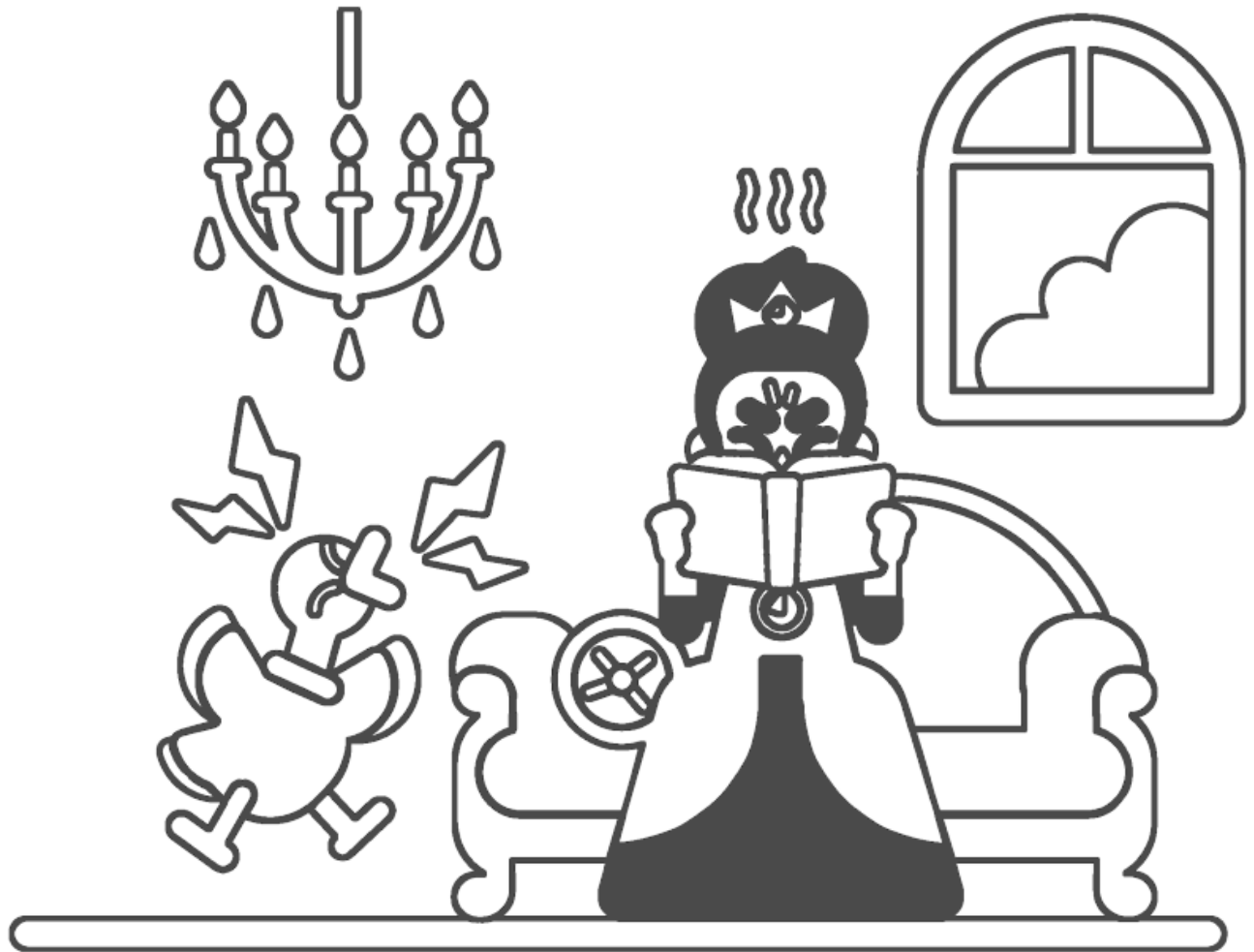

"Quack! Quack" said the duck.

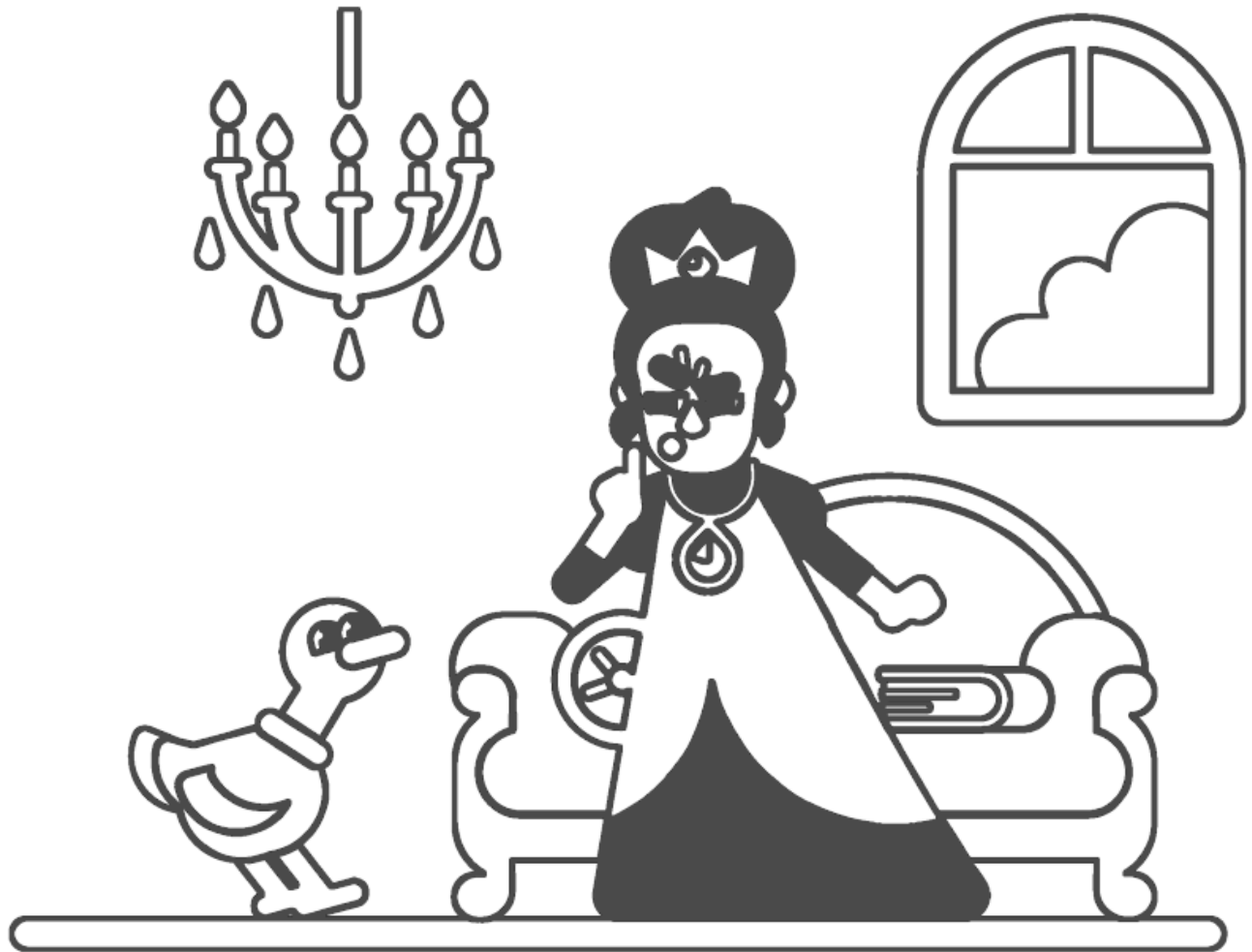

**"Please be quiet!" said
the queen.**



"OK, I quit," said the duck.



**"Oh! You can talk!" said
the queen.**



**"Say something!" said
the queen.**

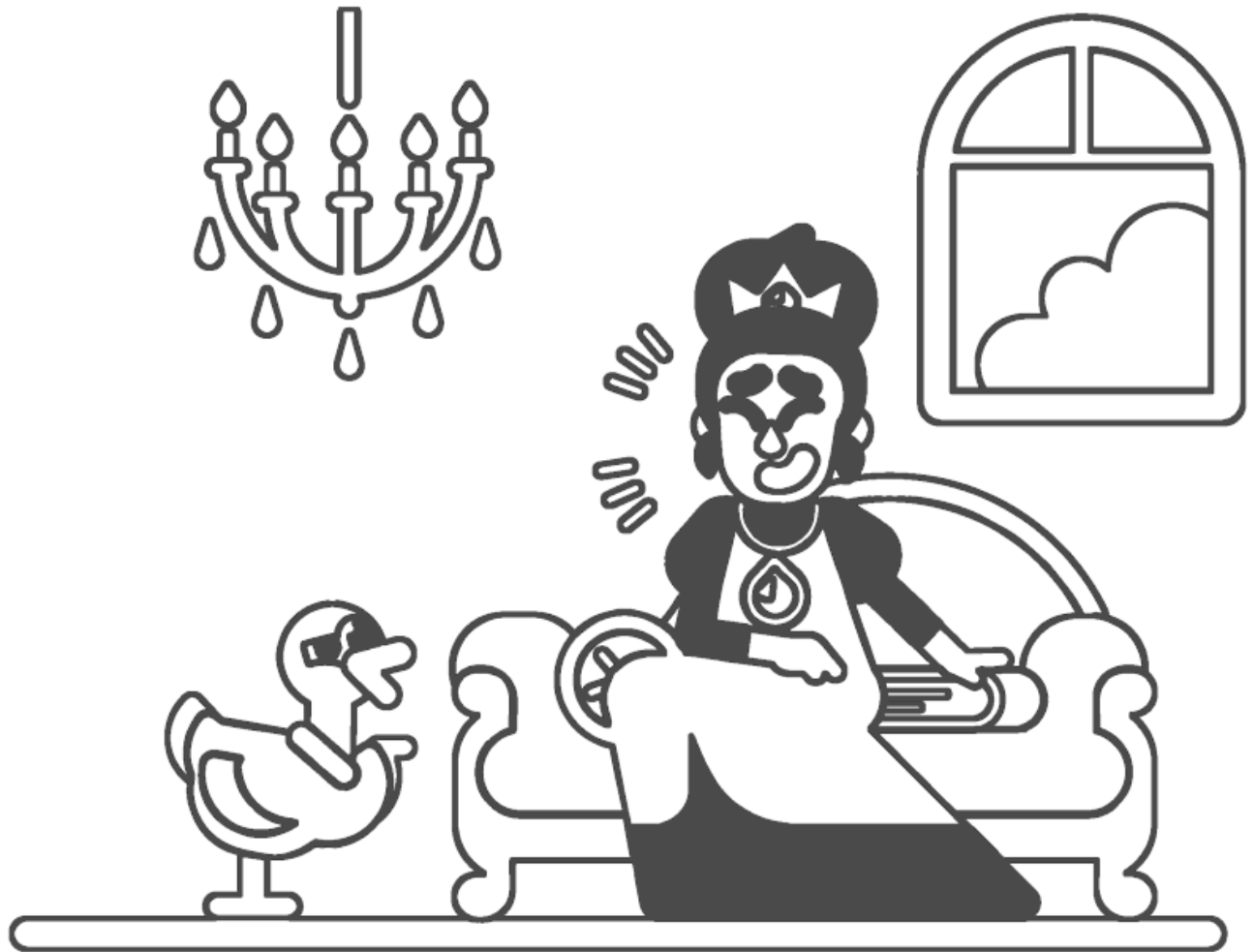

**"You told me to be
quiet."**

R r

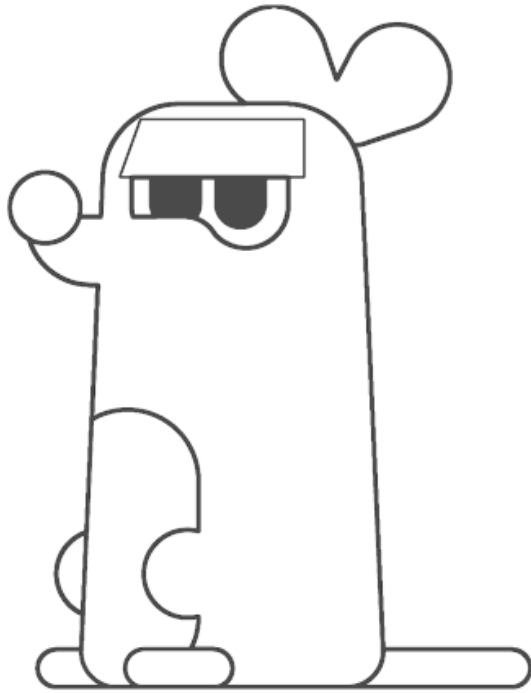

rat

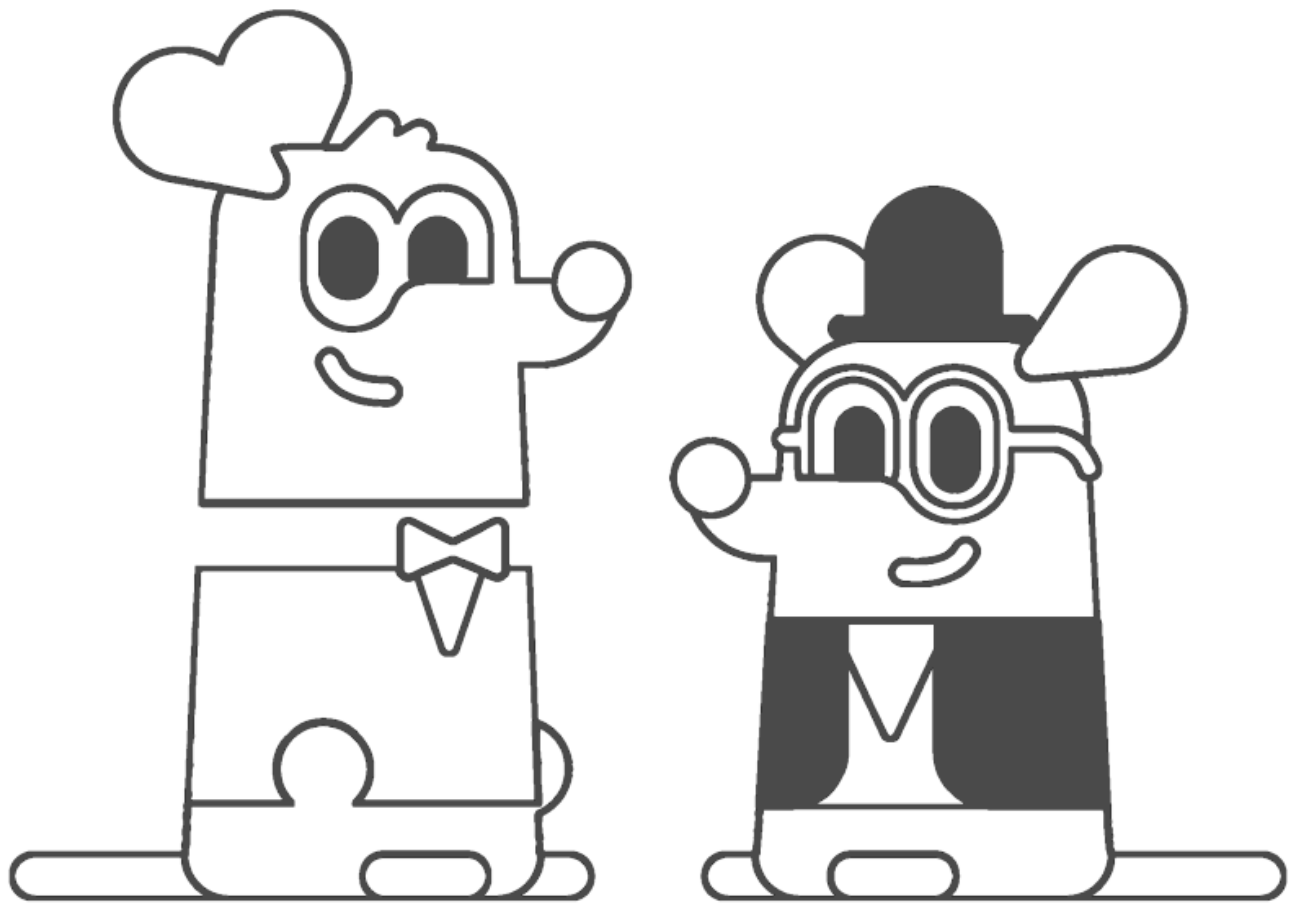

Look at the rats!

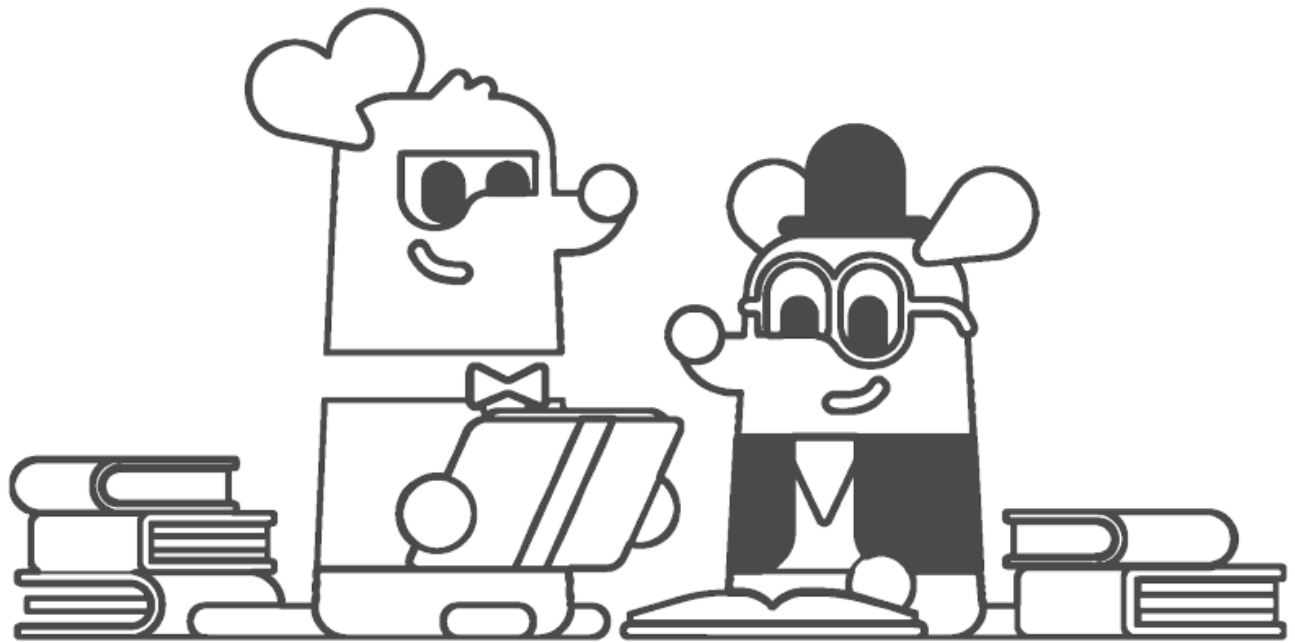

They love to read.

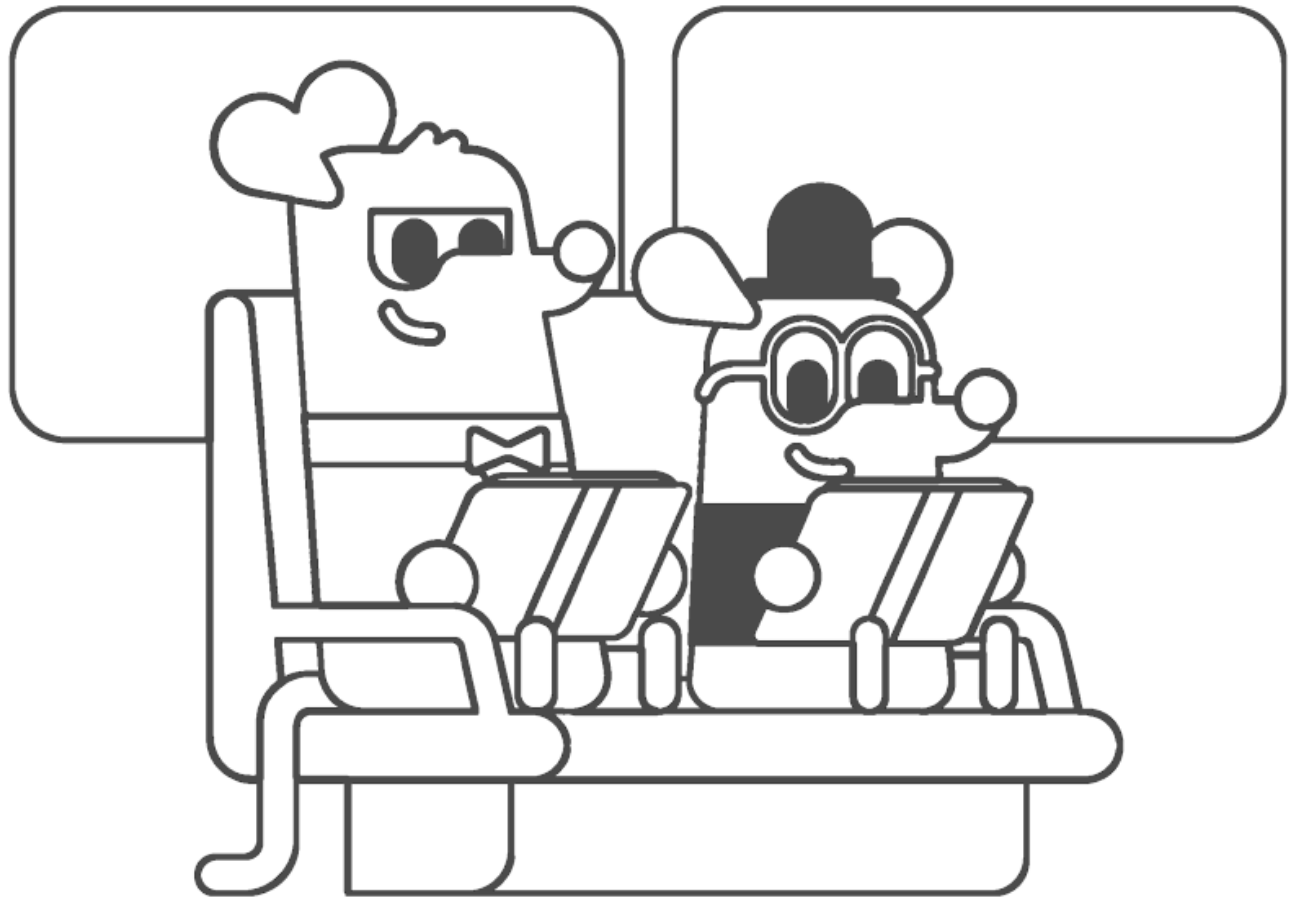

They read on the road.

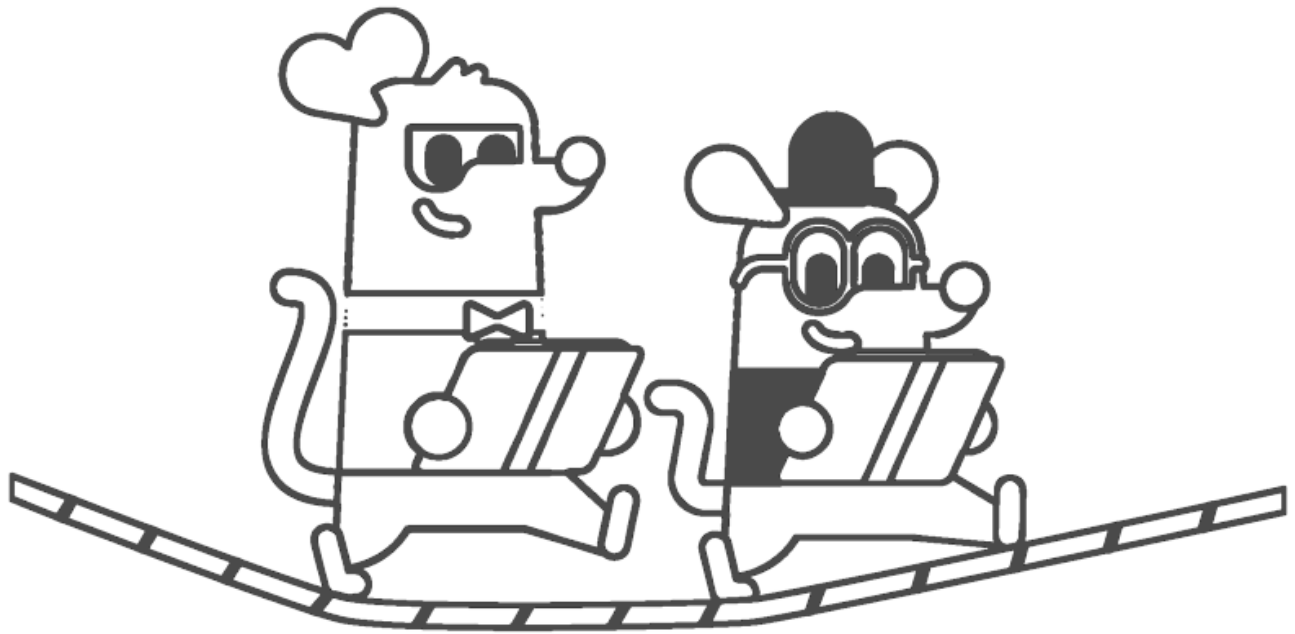

They read on the rope.

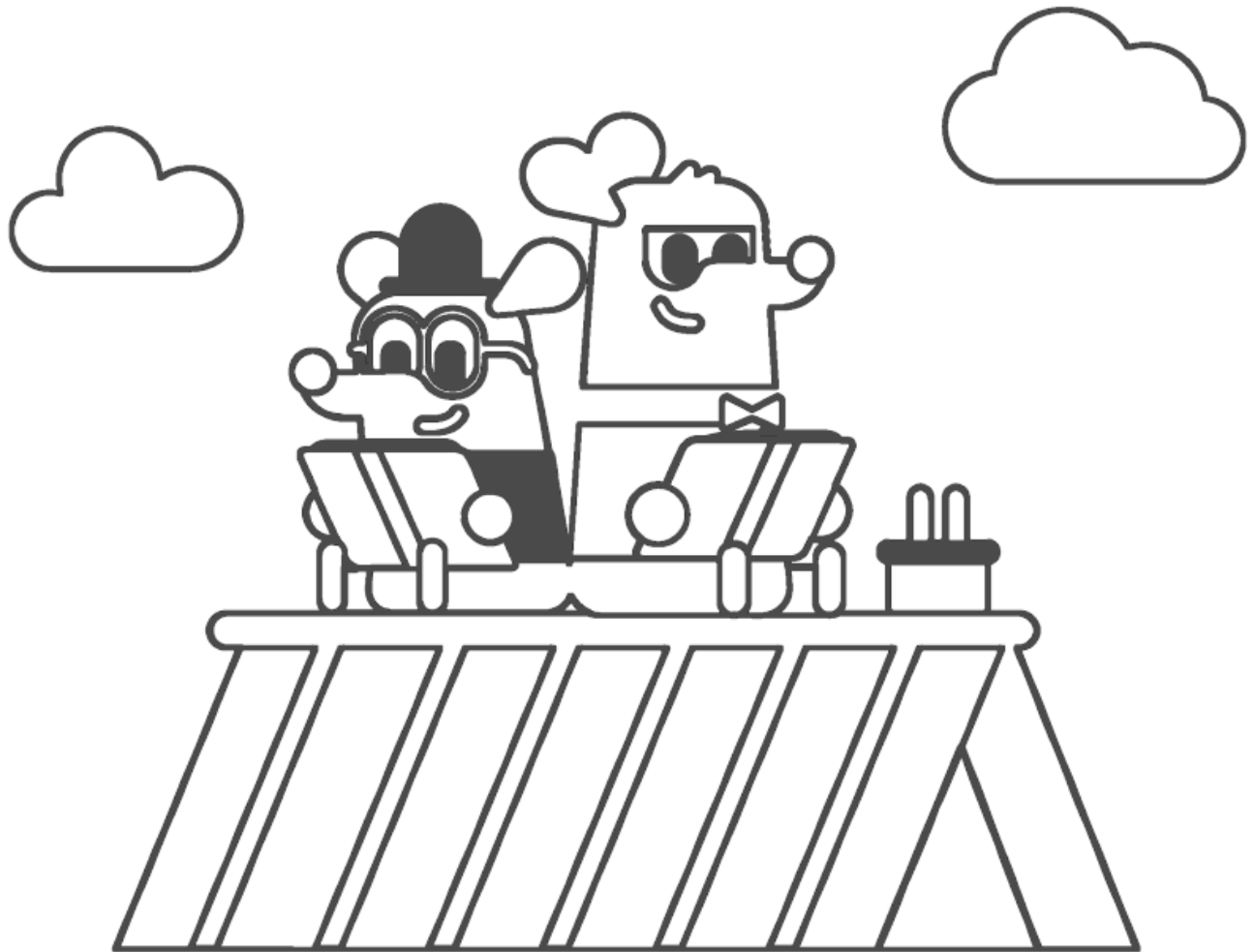

They read on the roof.



But not in the rain!

S s

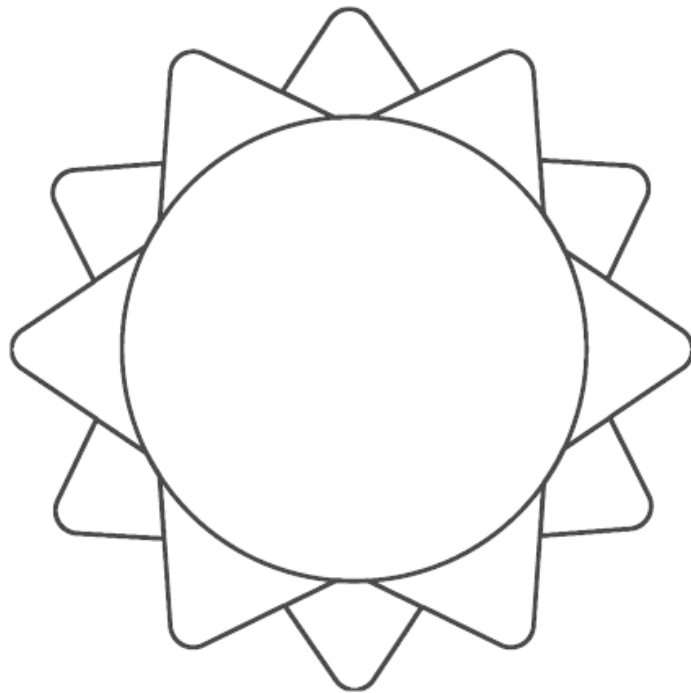

sun

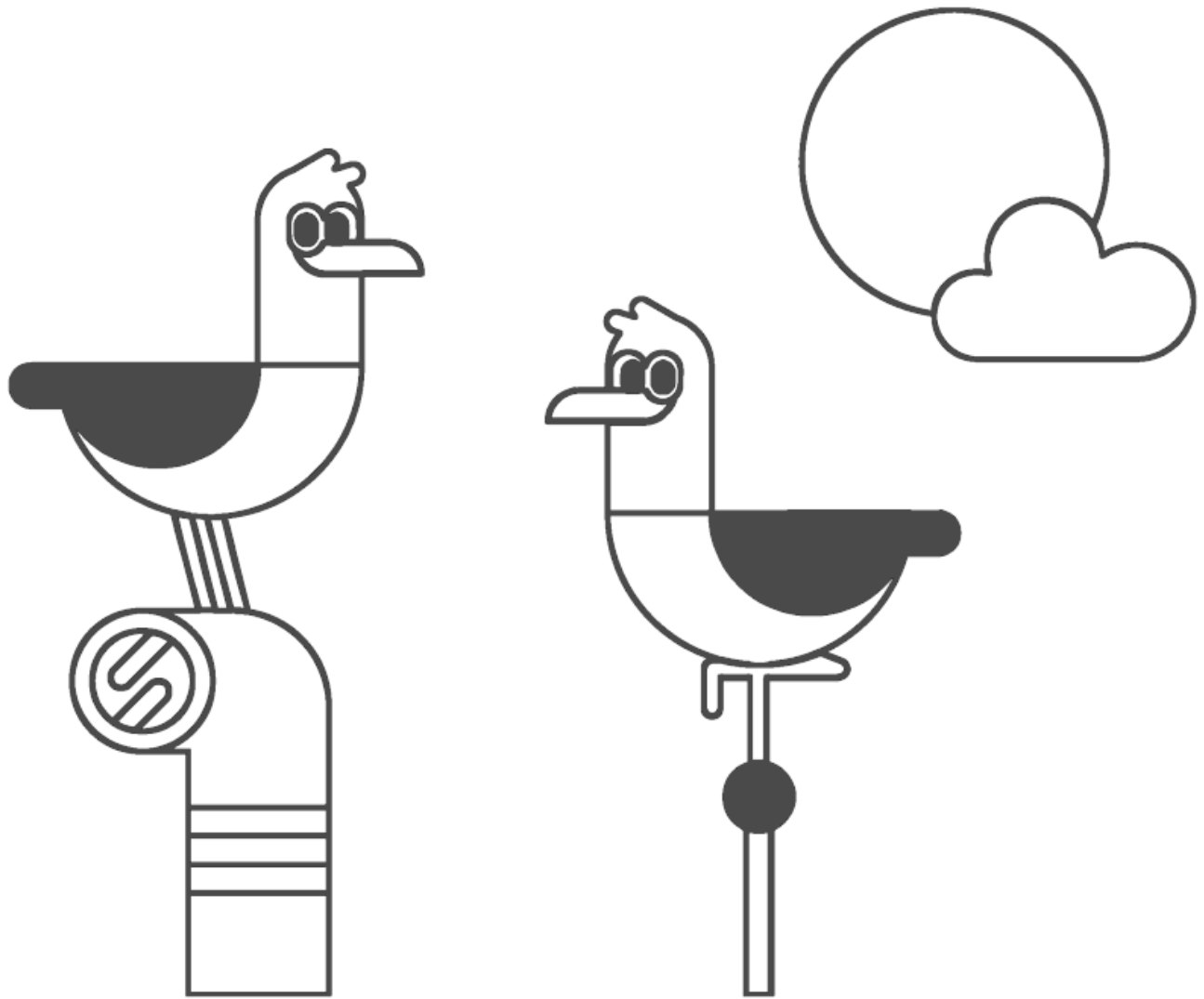

What do you see?

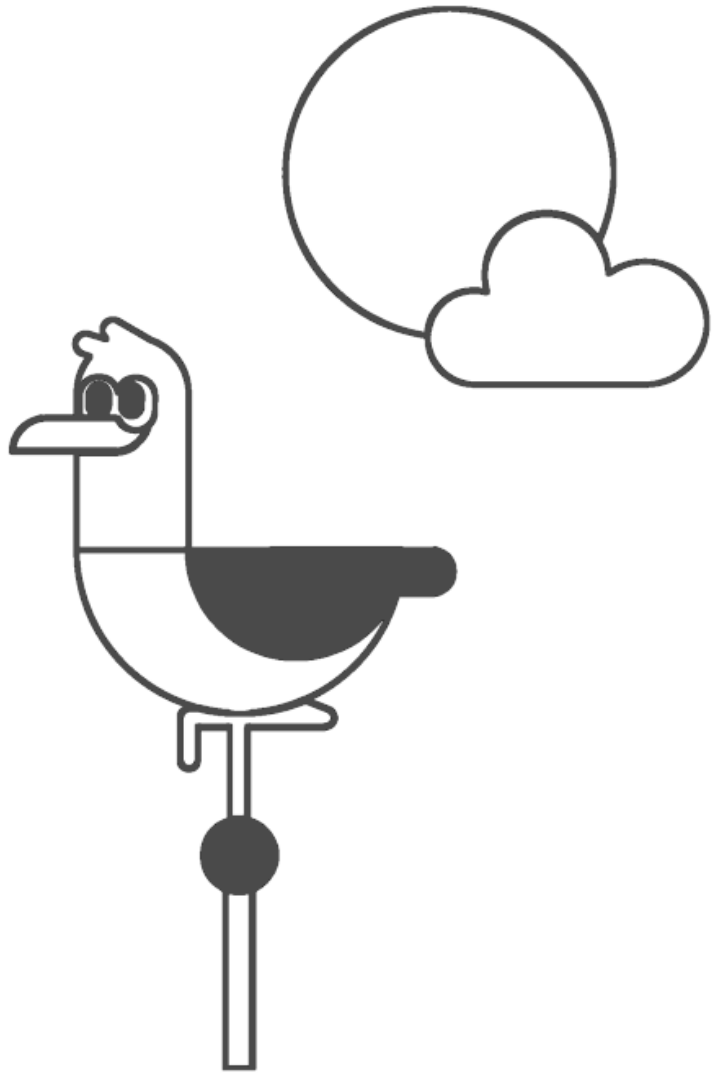
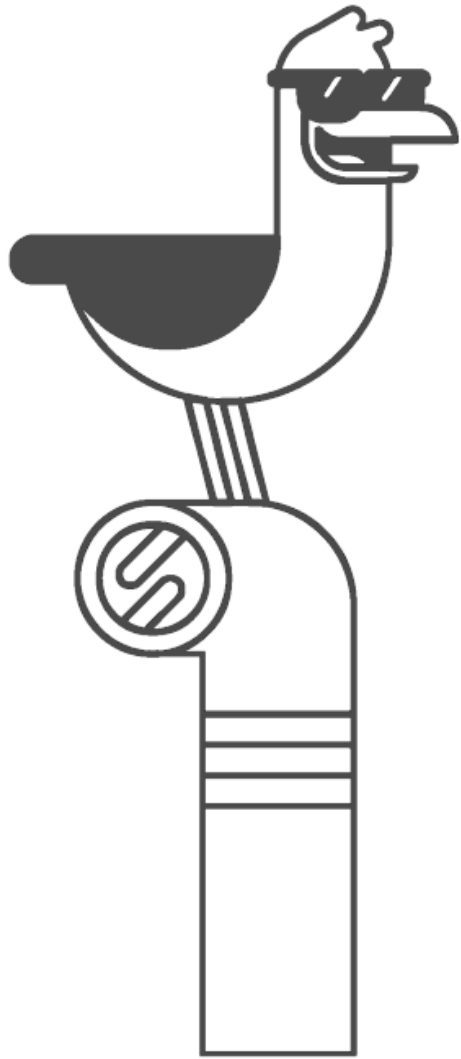

I see the sun.

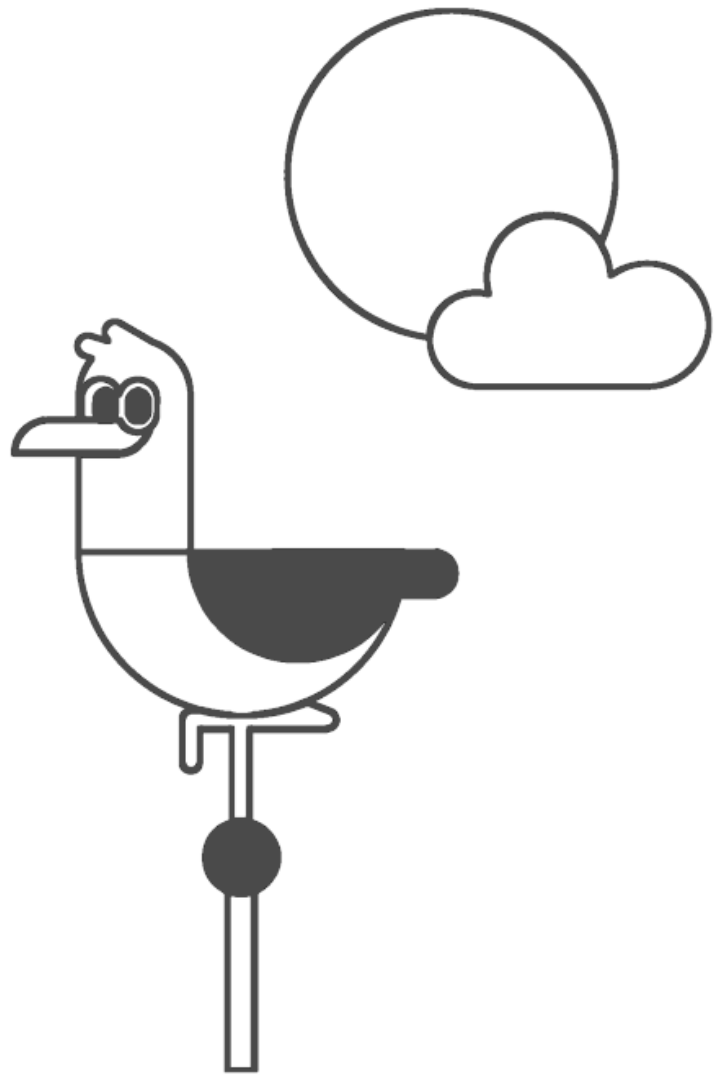
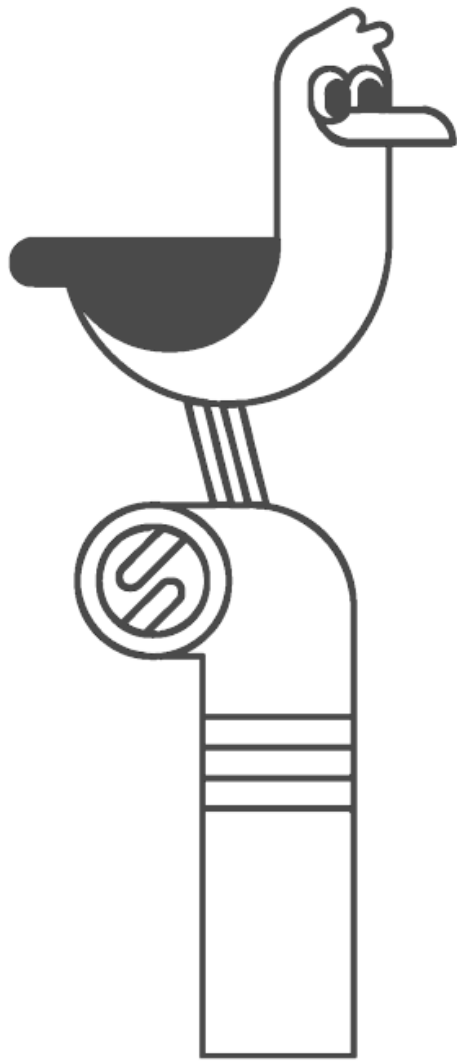

What do you see?

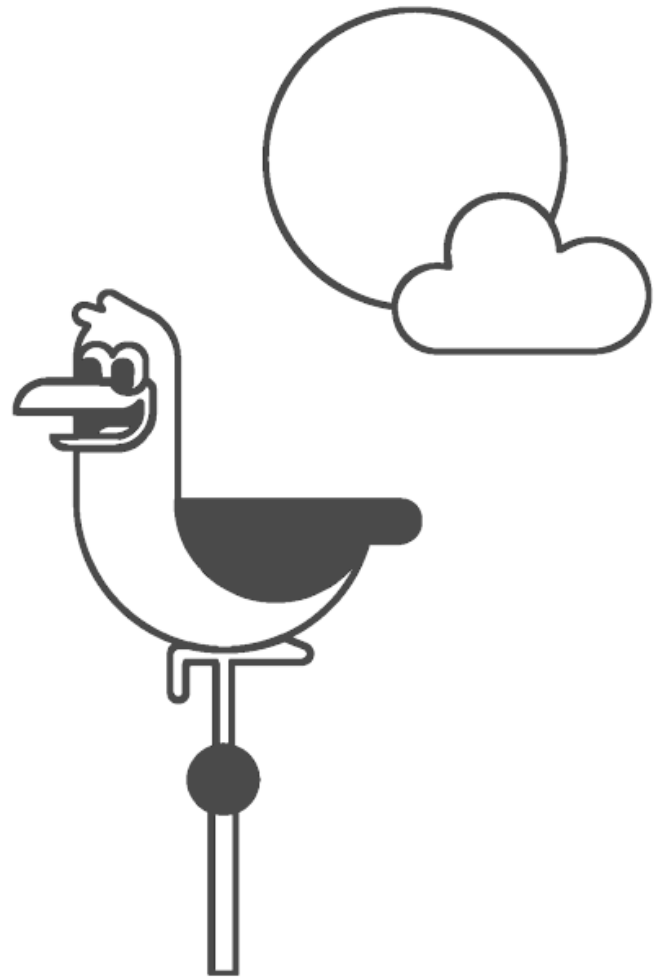
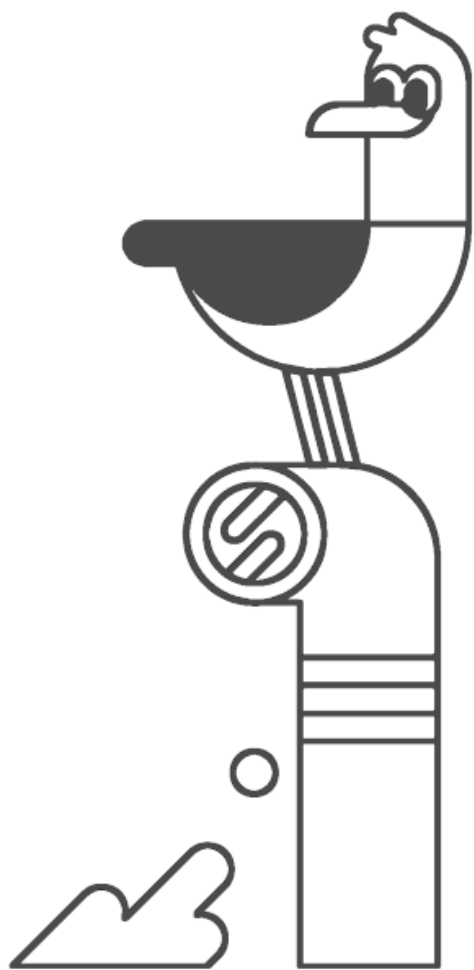

I see water.

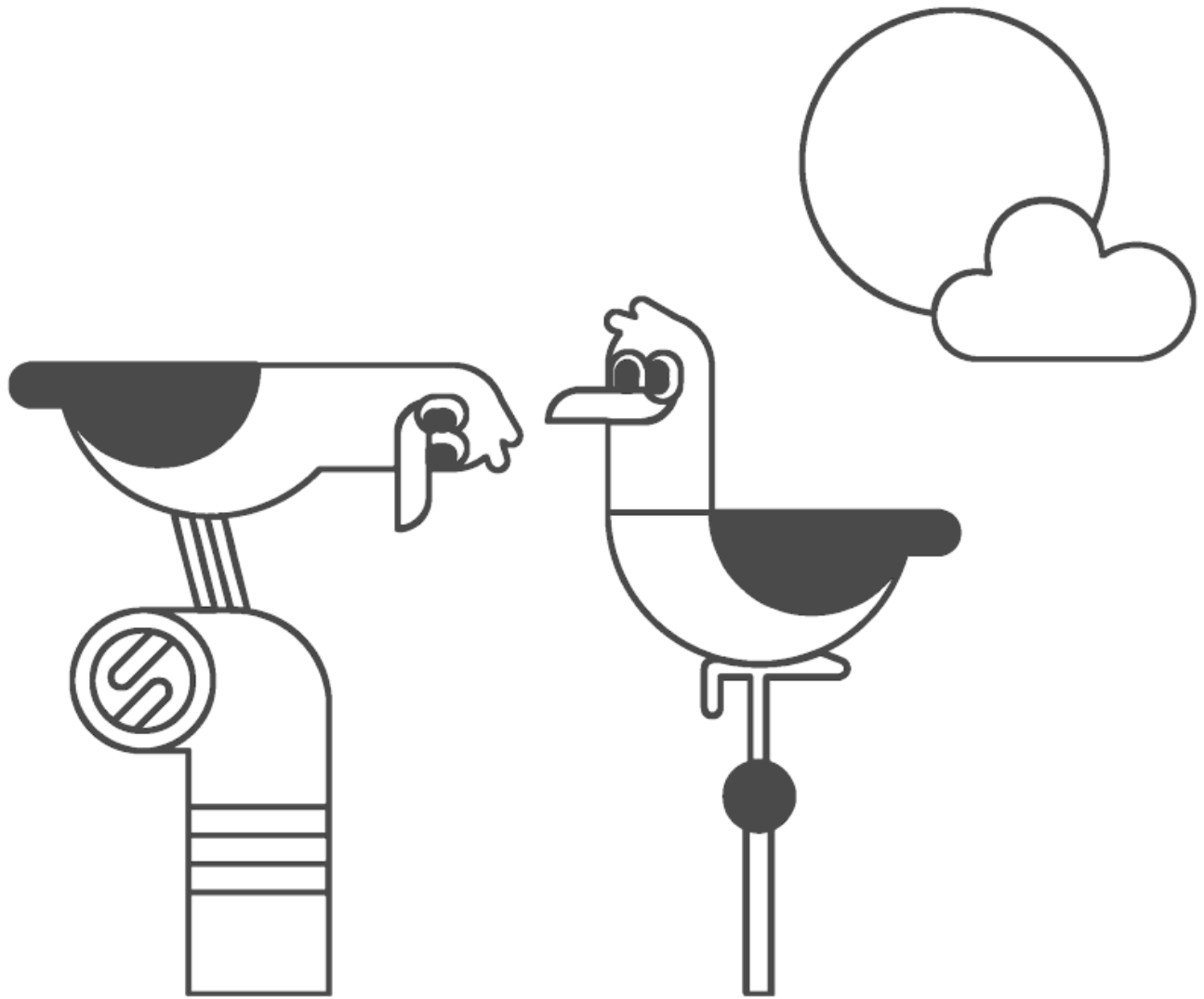

What do you see?

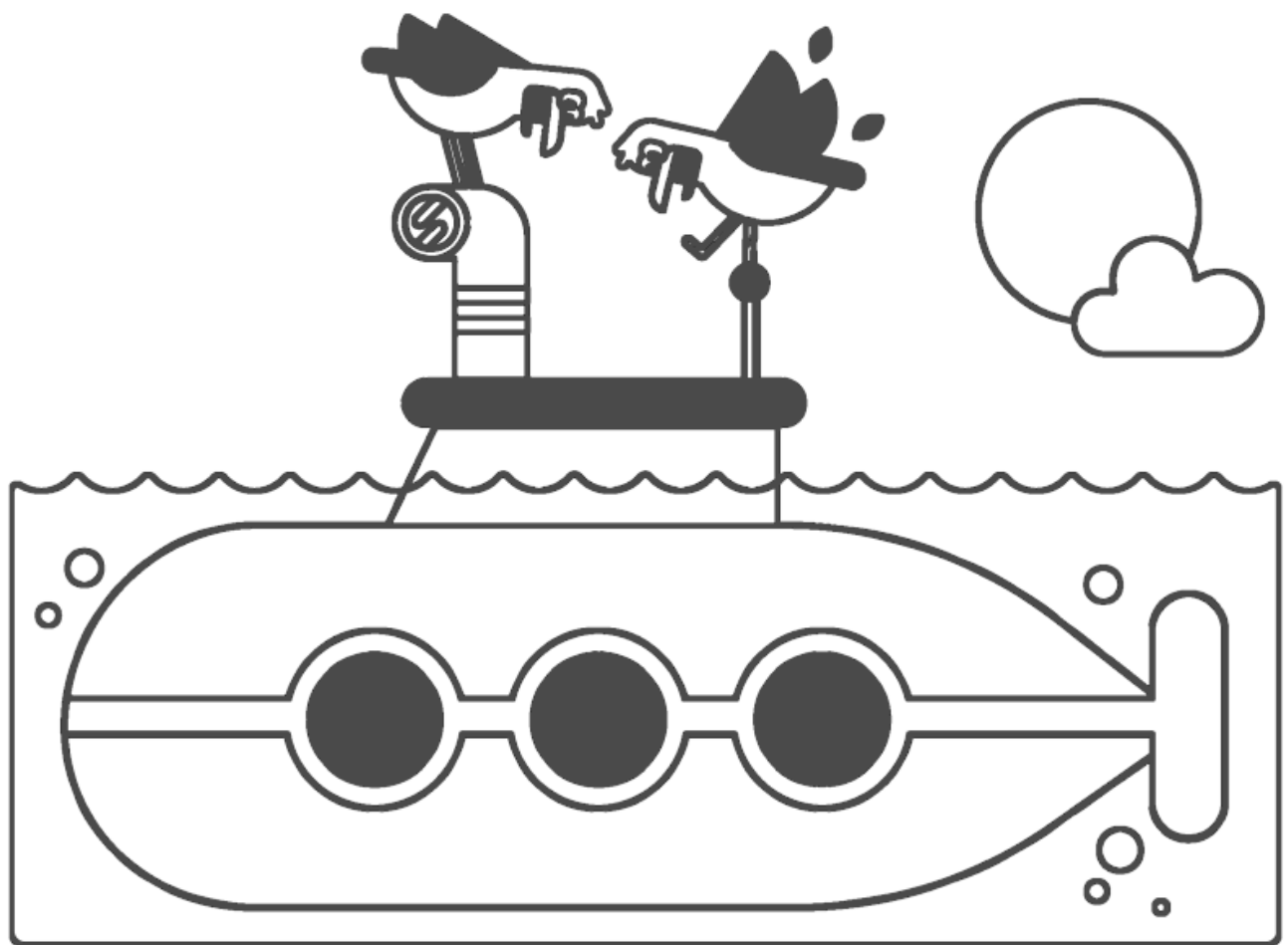

I see a submarine!

T t

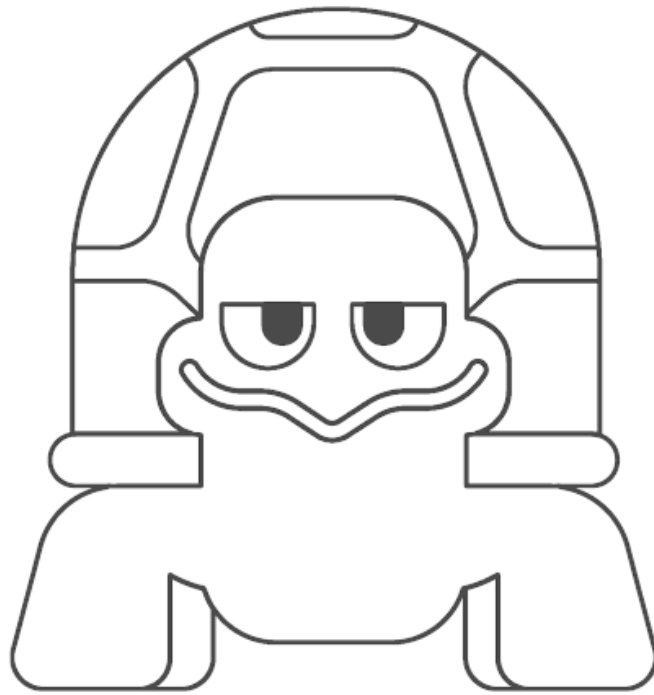

turtle

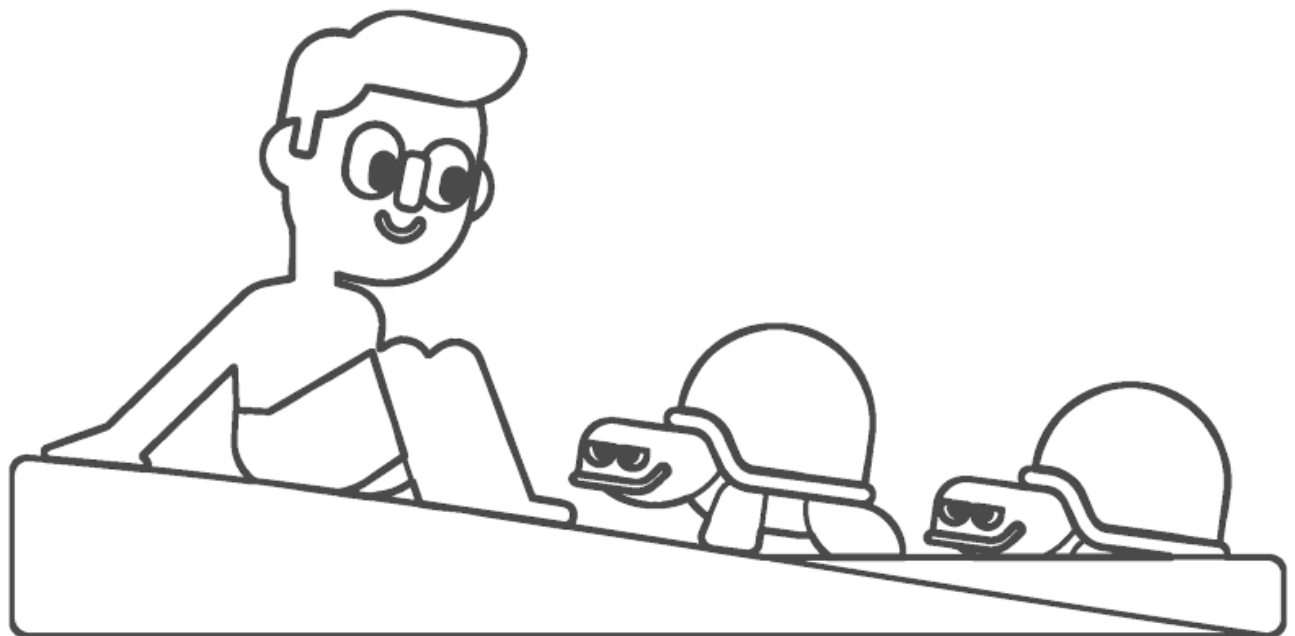

Turtles go out.

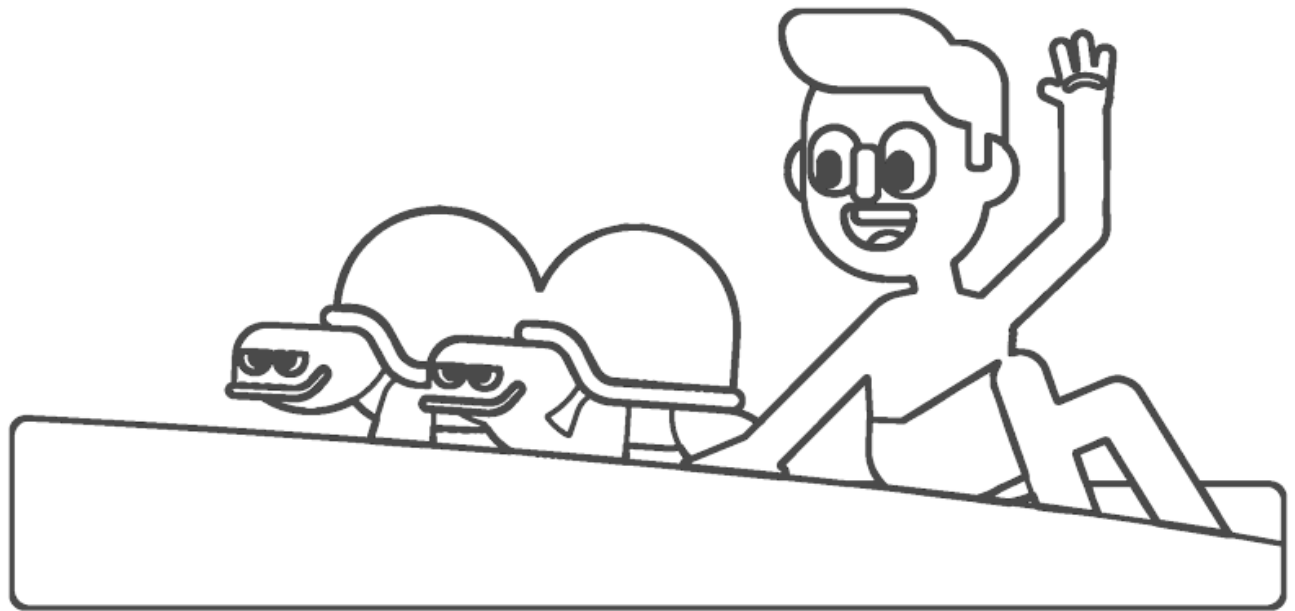

Hello, turtles!

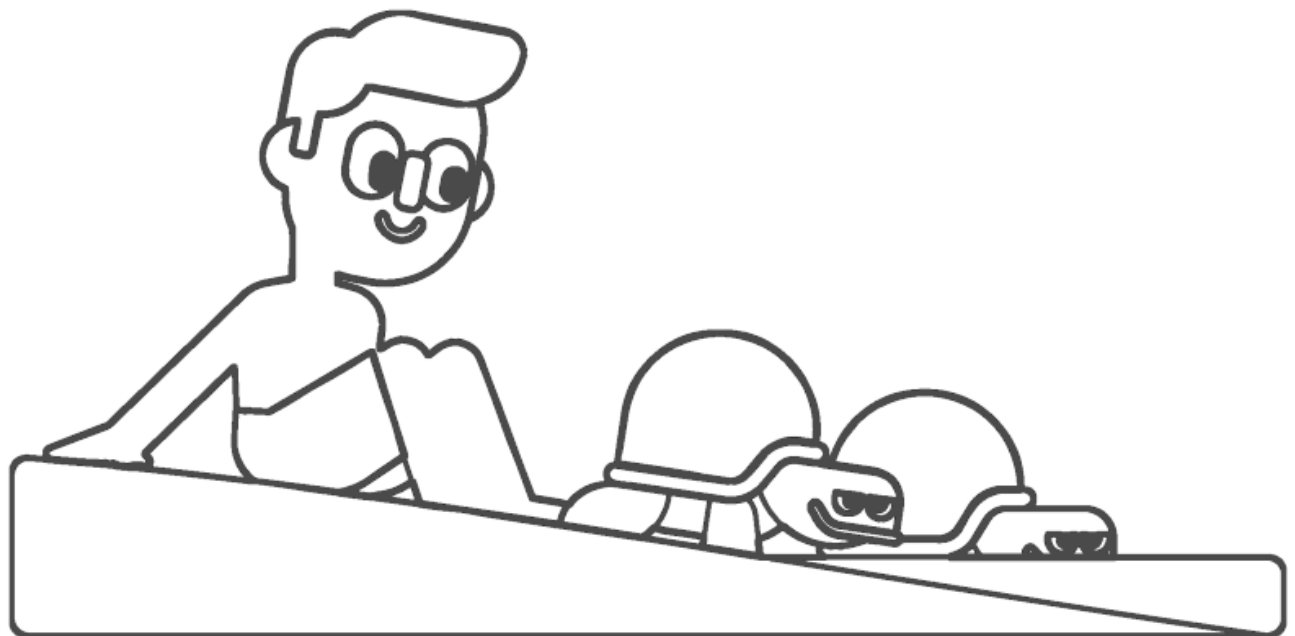

Turtles go in.

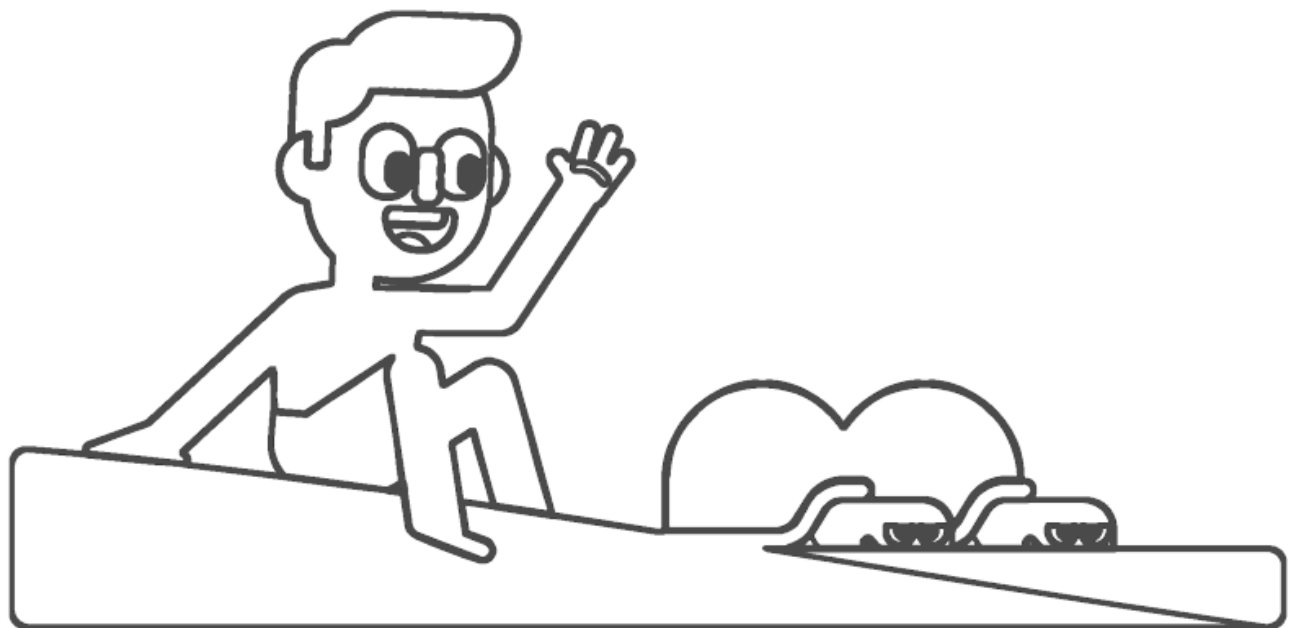

Bye-bye, turtles!

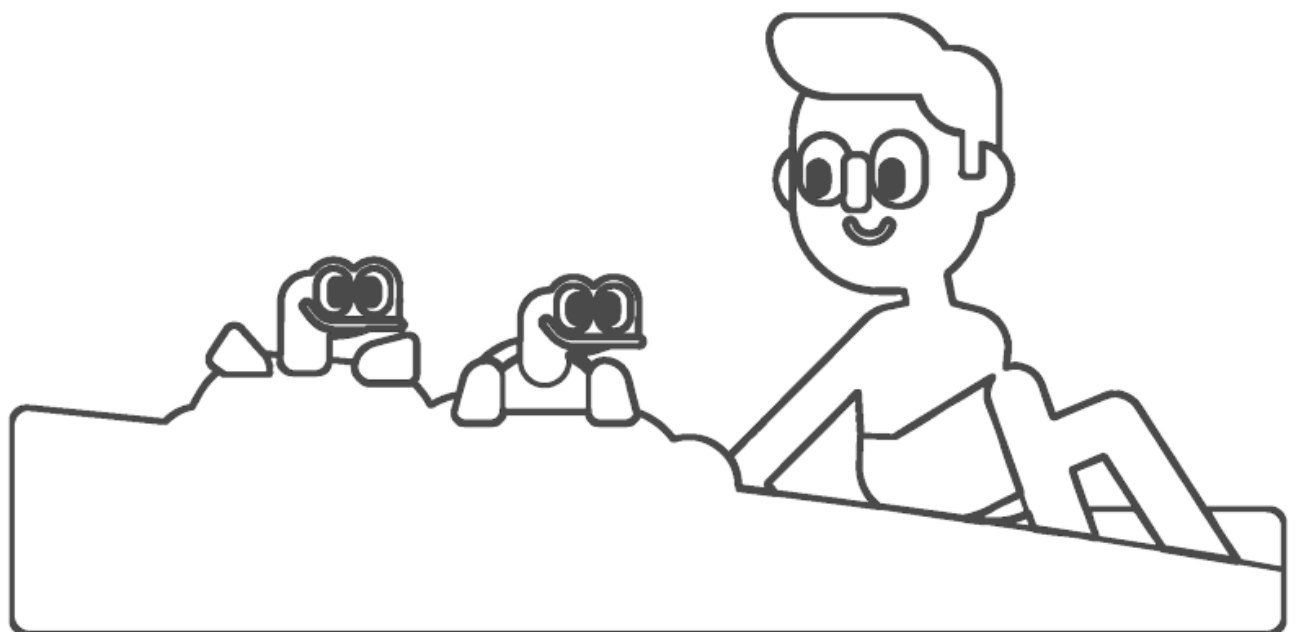

Tiny turtles go out.

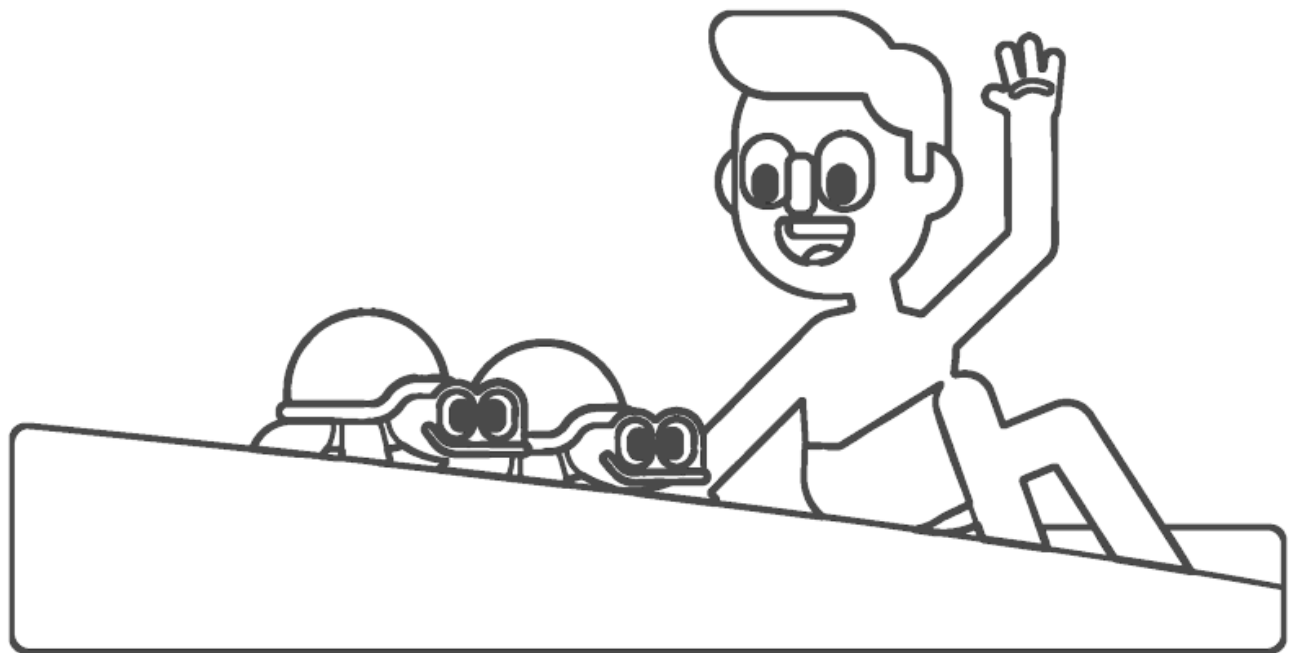

Hello, tiny turtles!

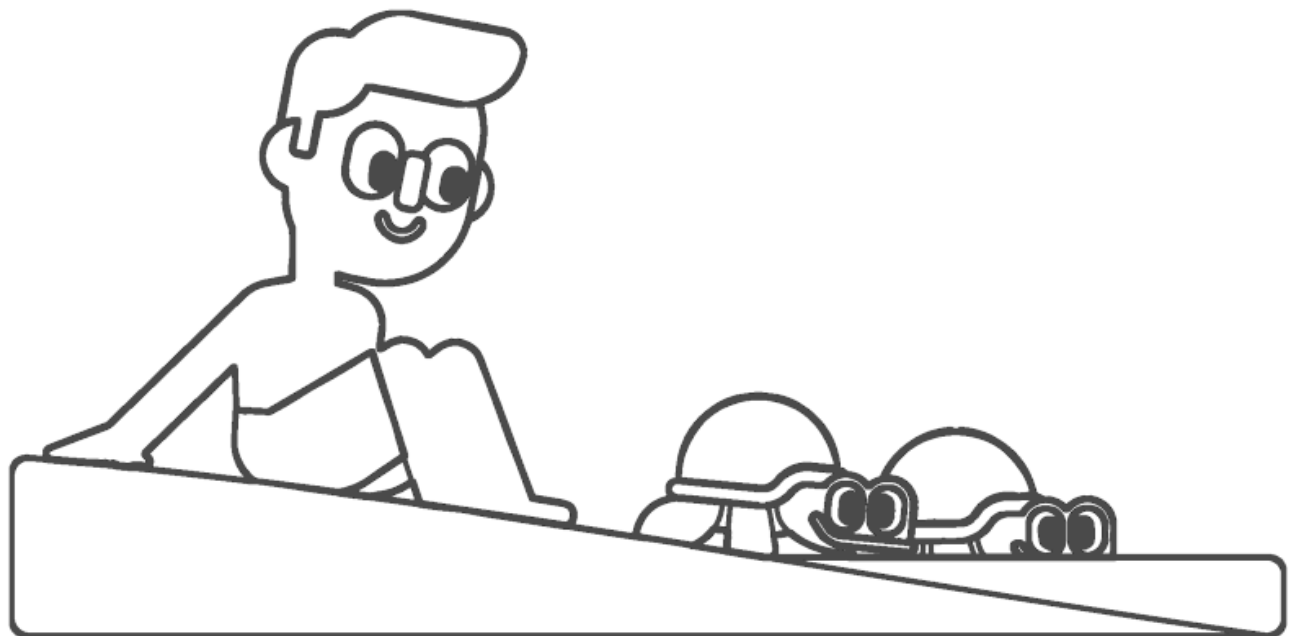

Tiny turtles go in.

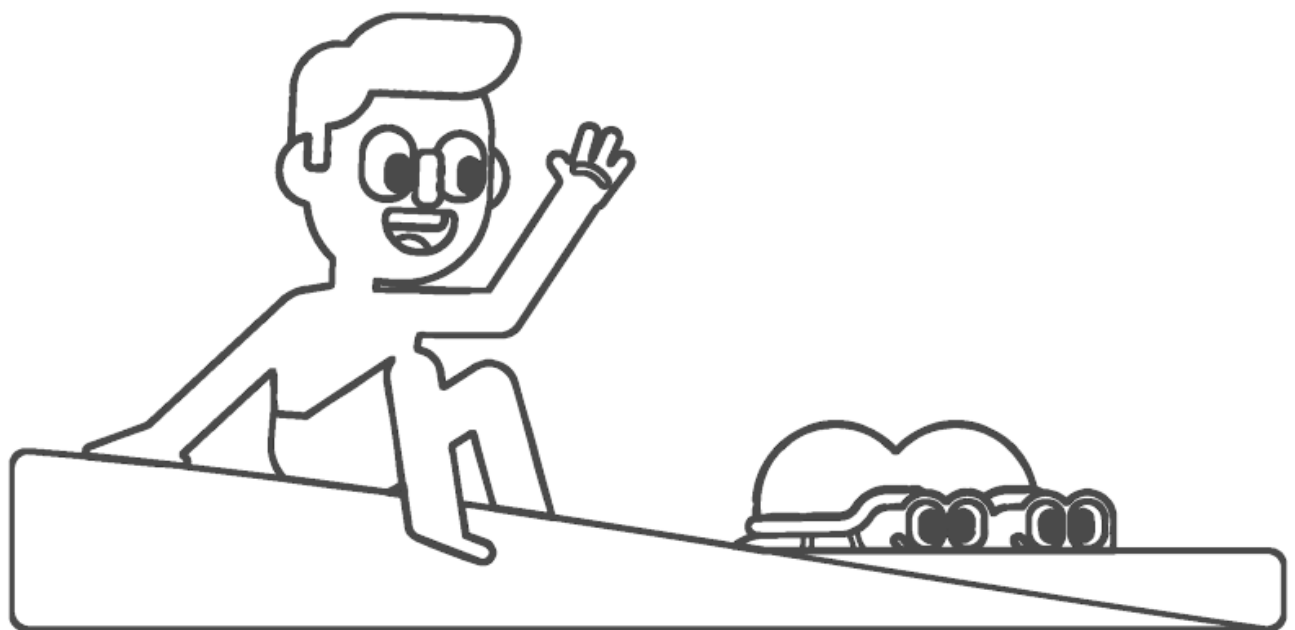

Bye-bye, tiny turtles!

U u



umbrella

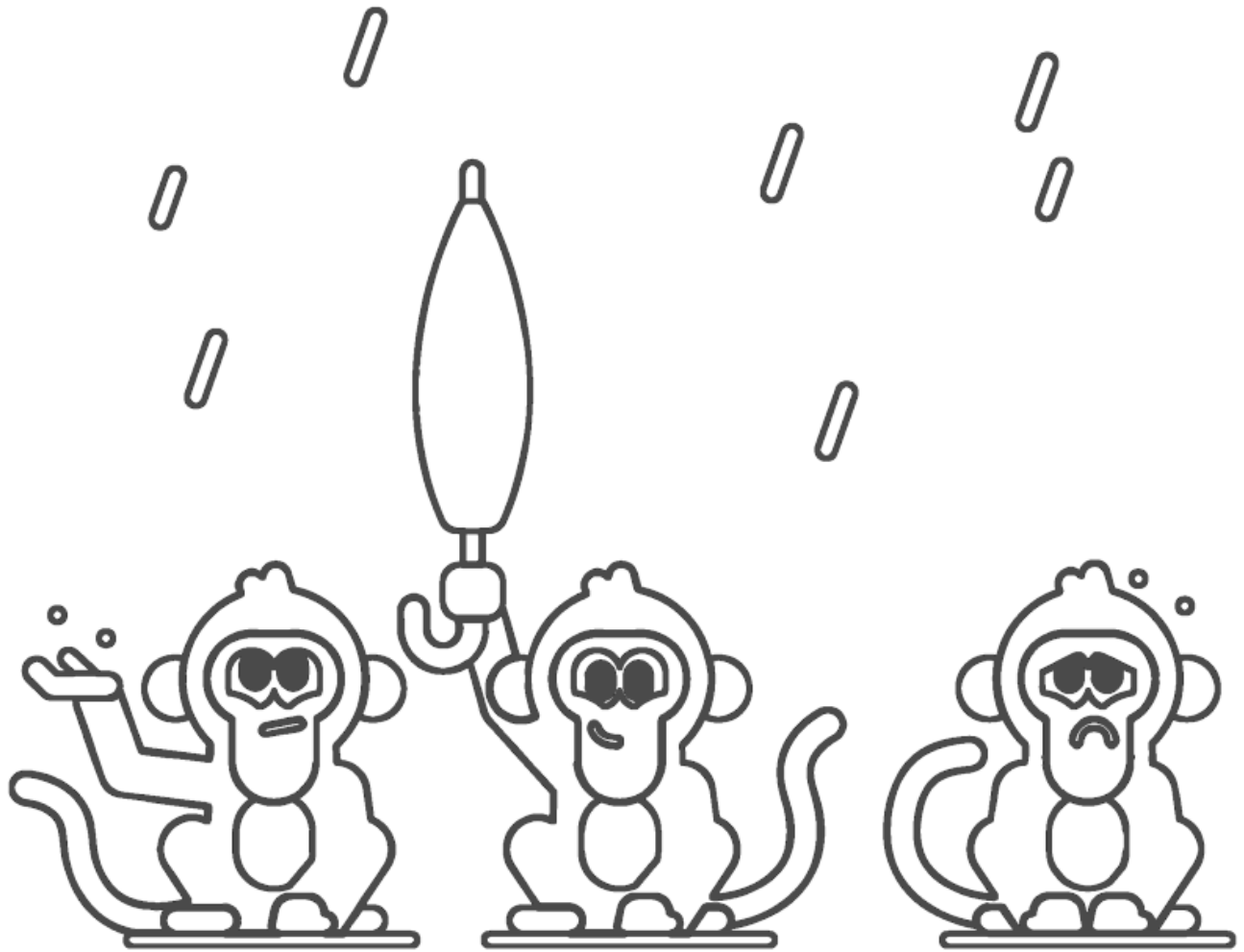

I have an umbrella!



It is up.



We are all under!



**Moo! Can I get under
too?**



Um, yes?

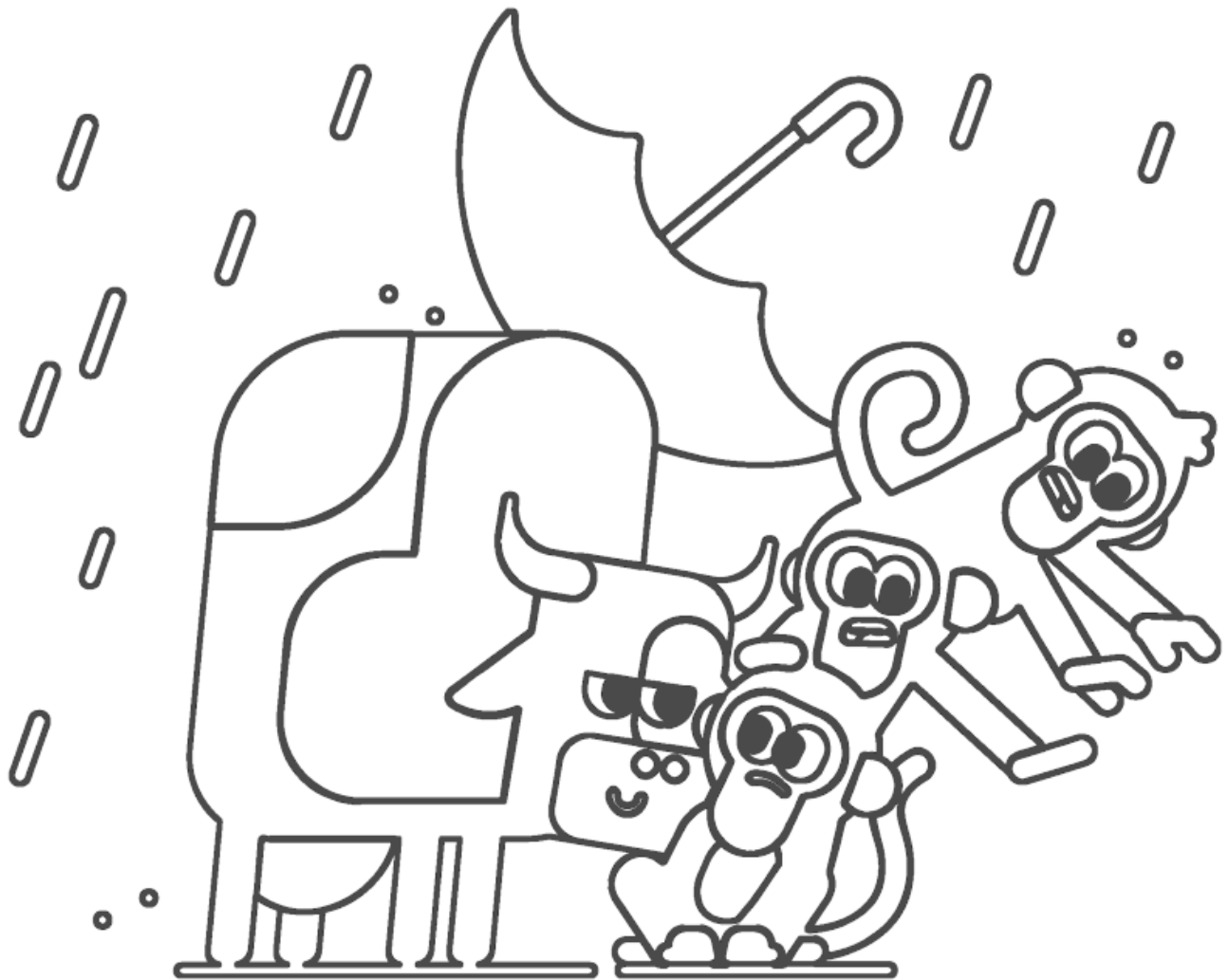

Uh-oh!

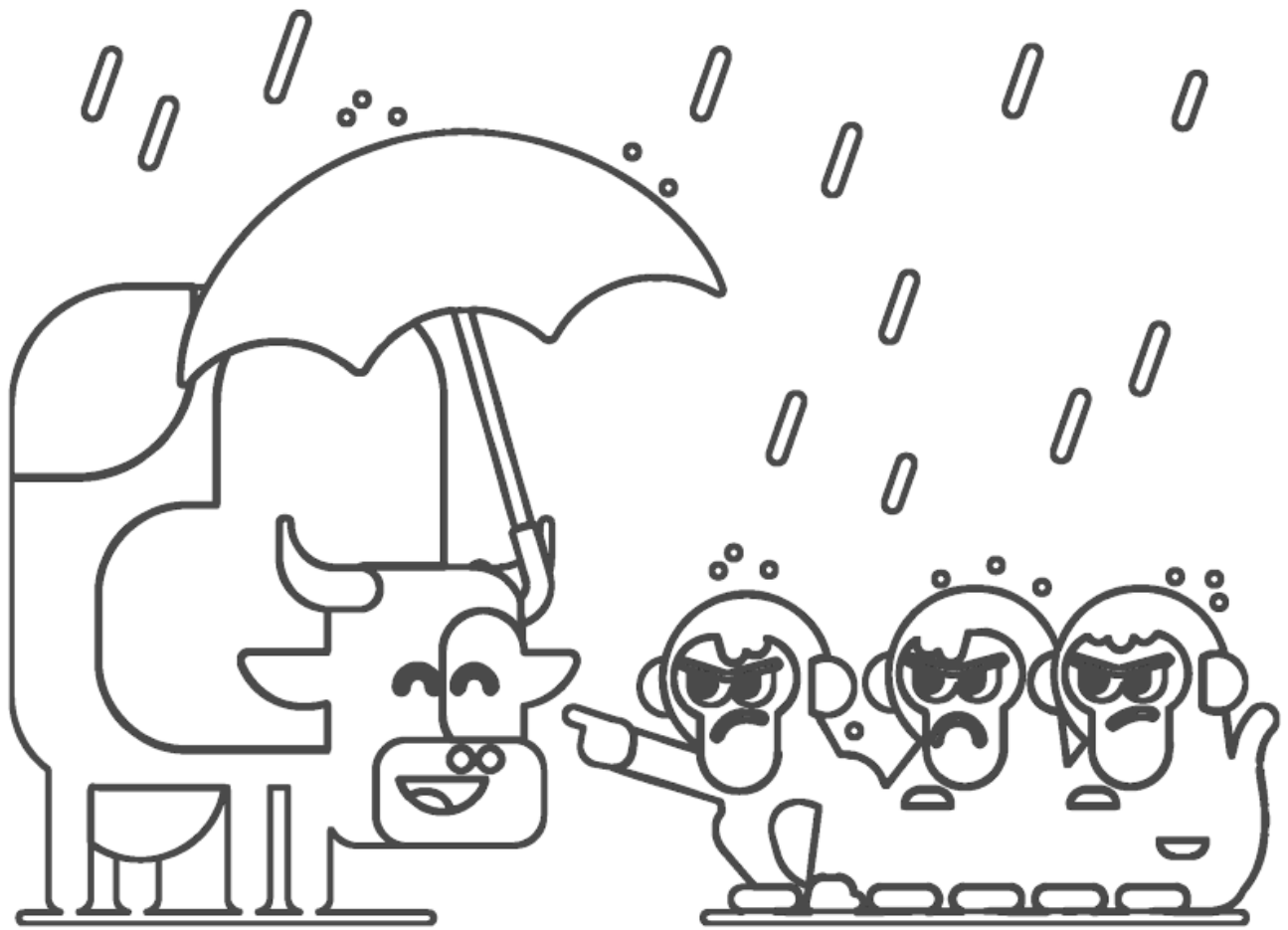

I am under!

V v

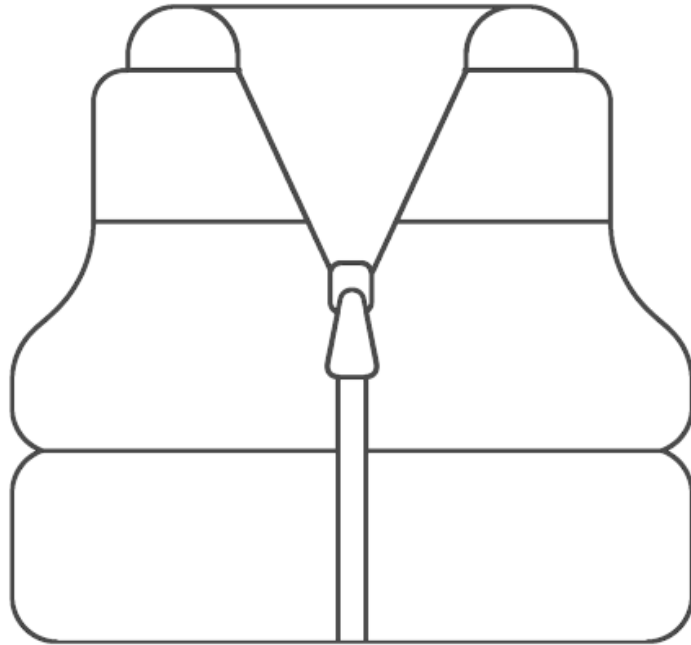

vest



How is my vest?

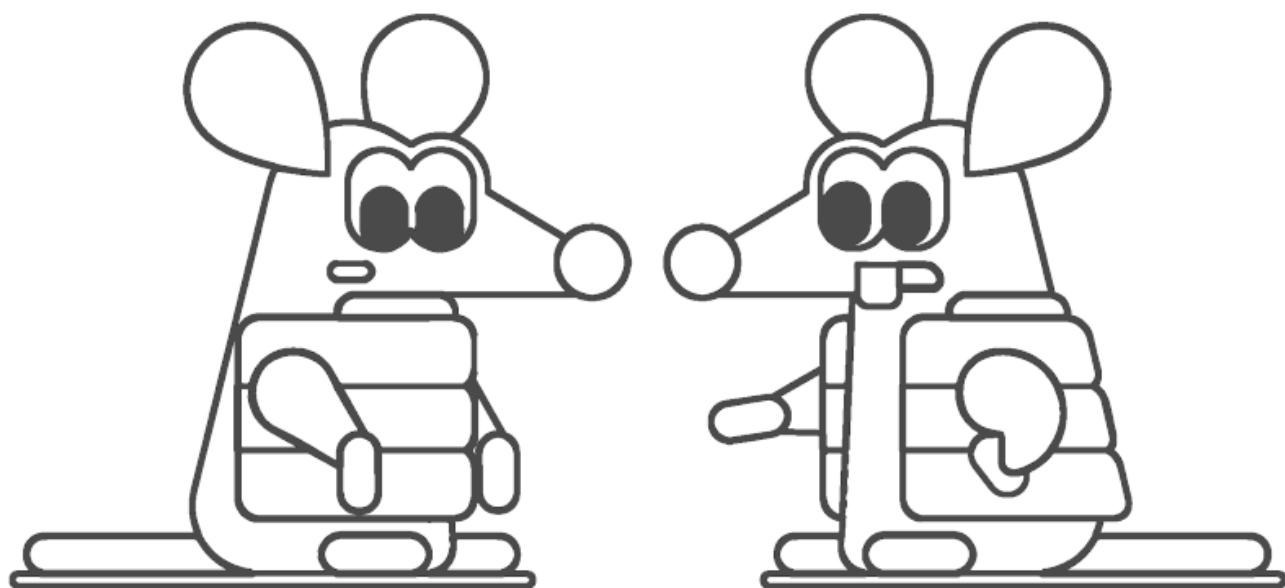

Not very good.

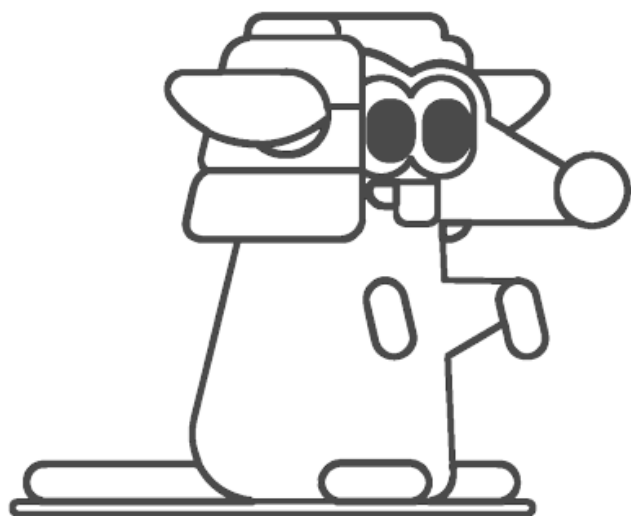

How is my vest now?

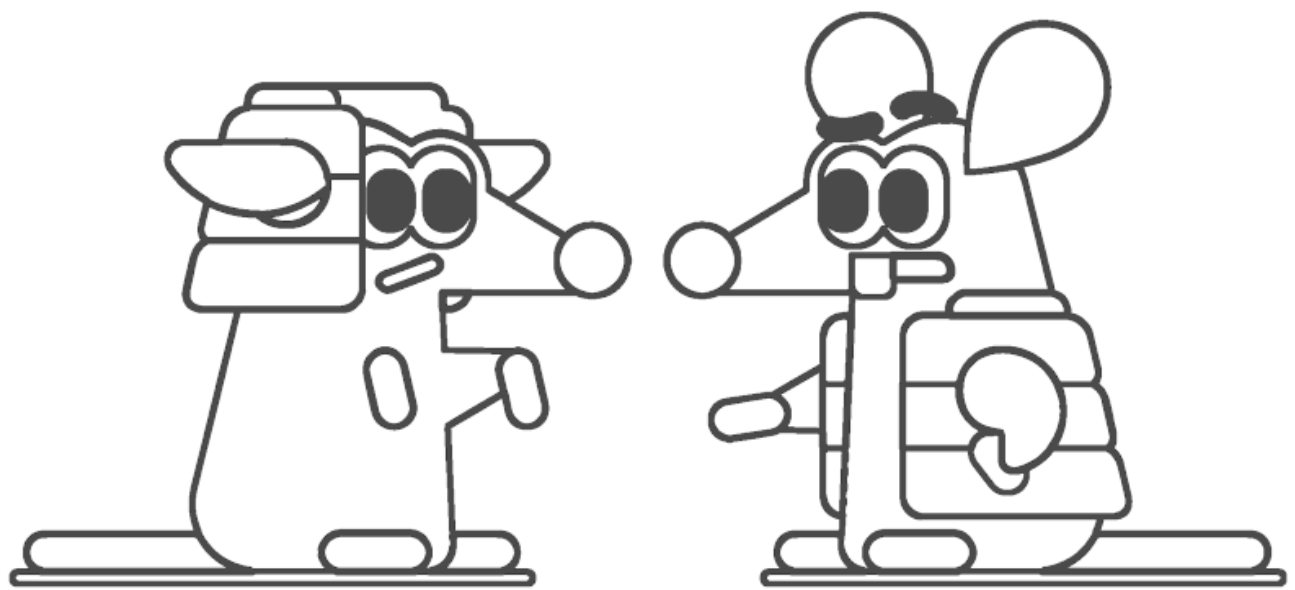

Not very good.

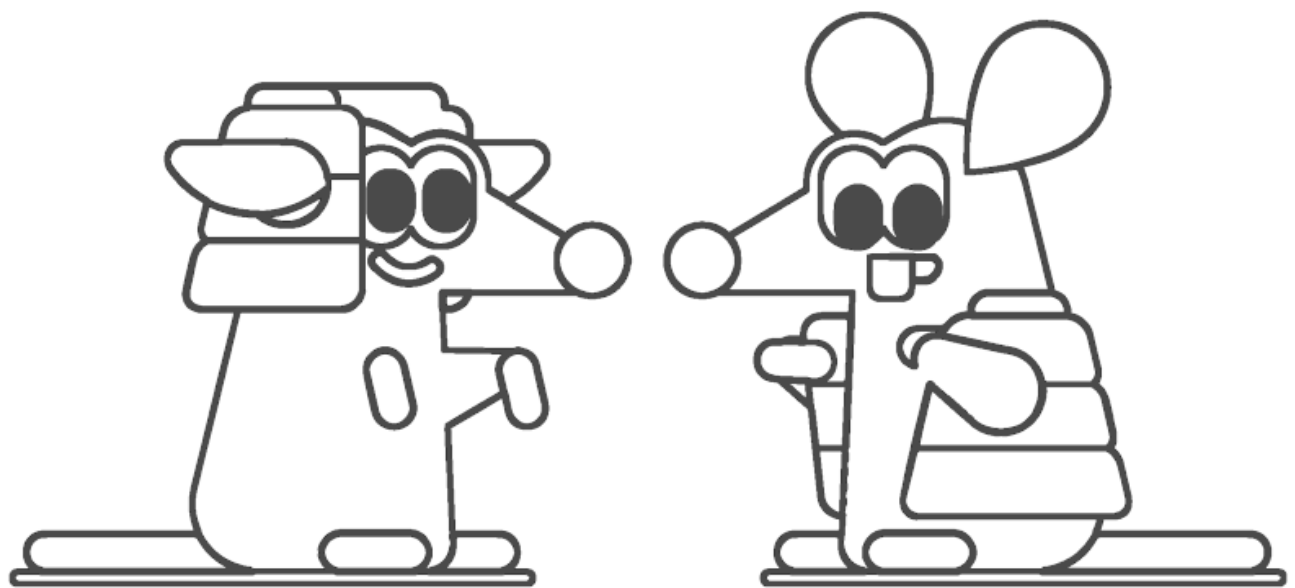

Look at my vest!

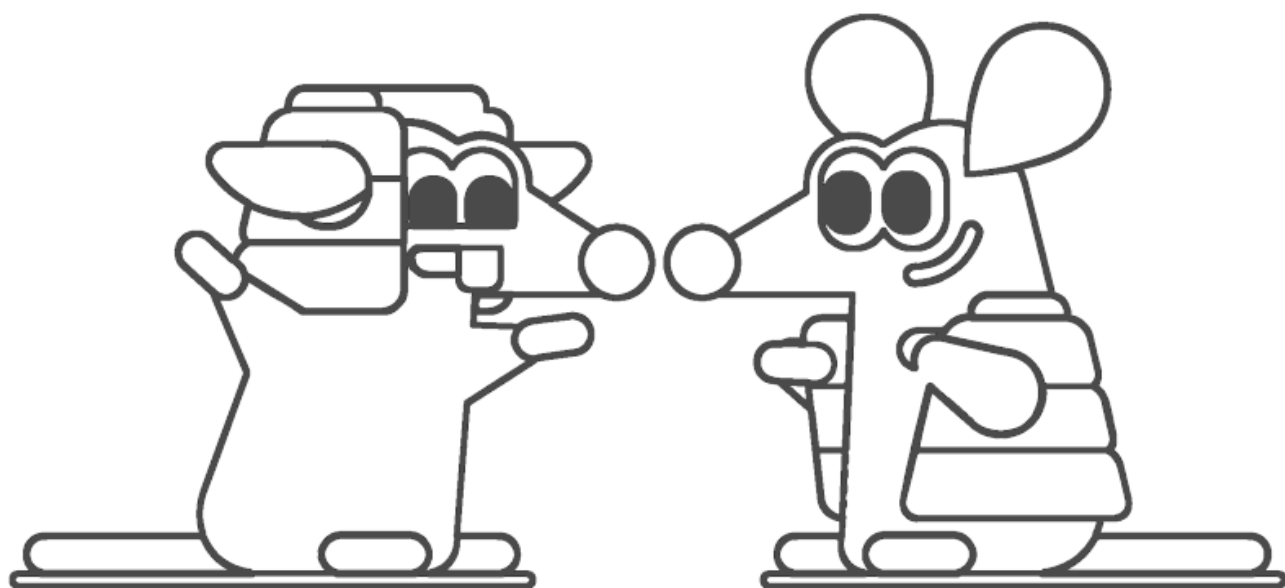

Oh, that is very good!



Can I have your vest?

W w

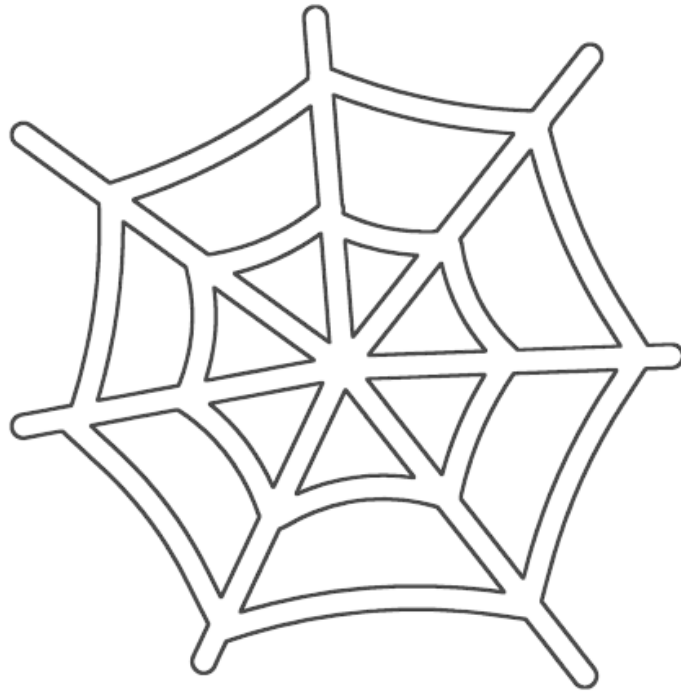

web

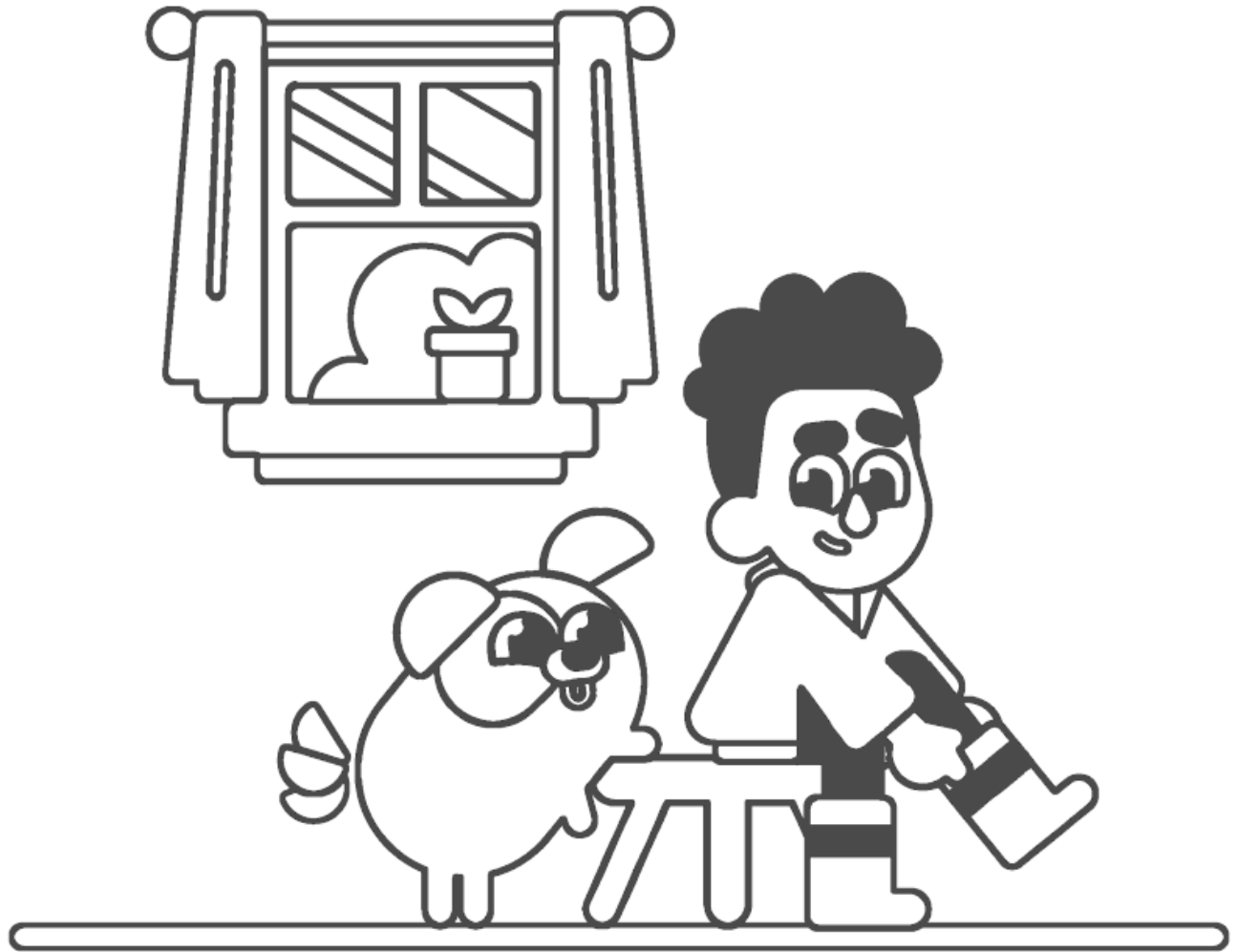

**Let's walk in the
woods!**

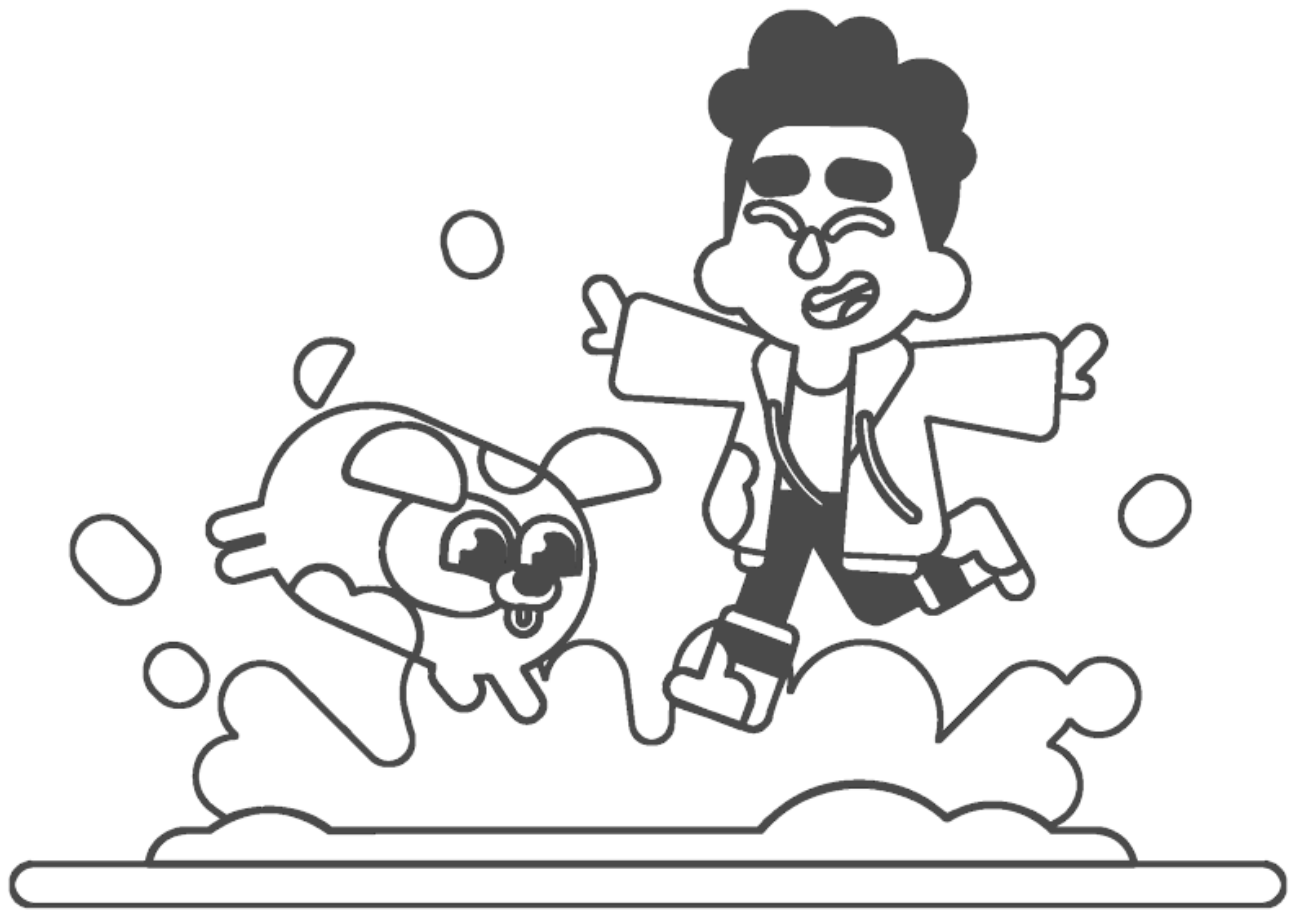

We love water!

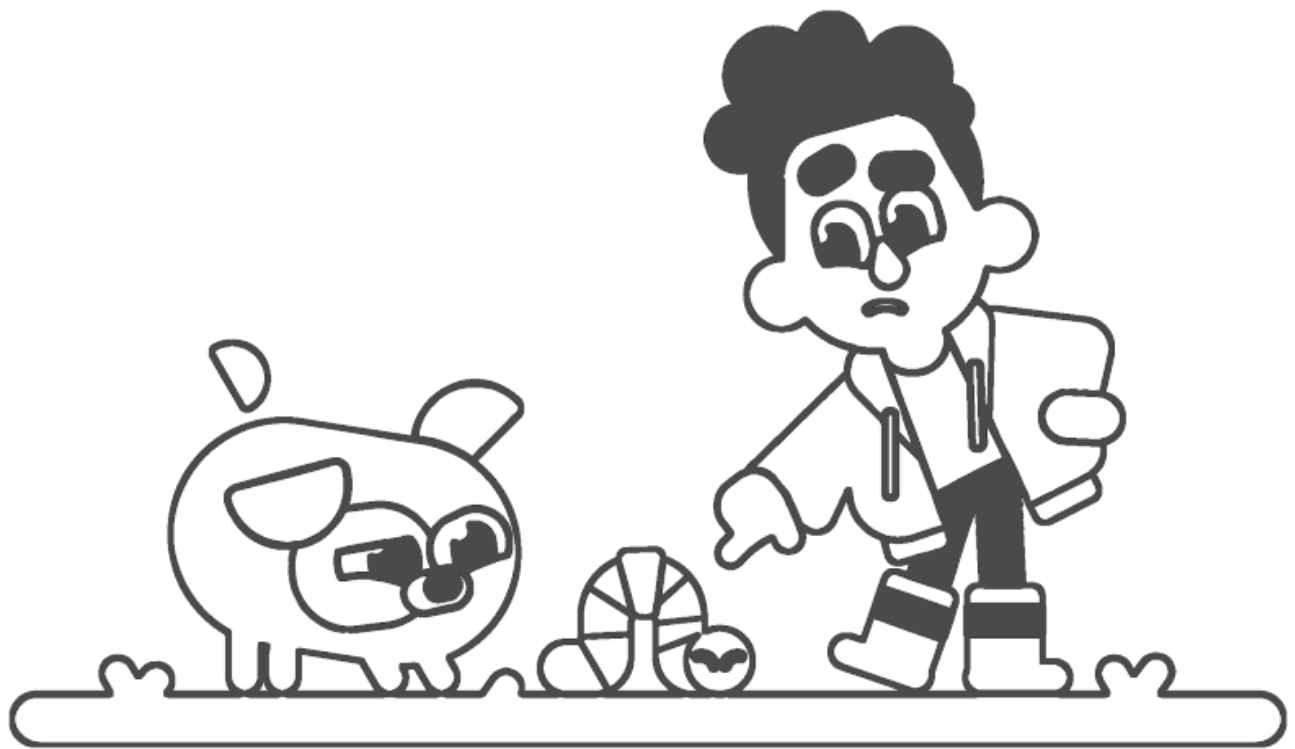

There's a worm.

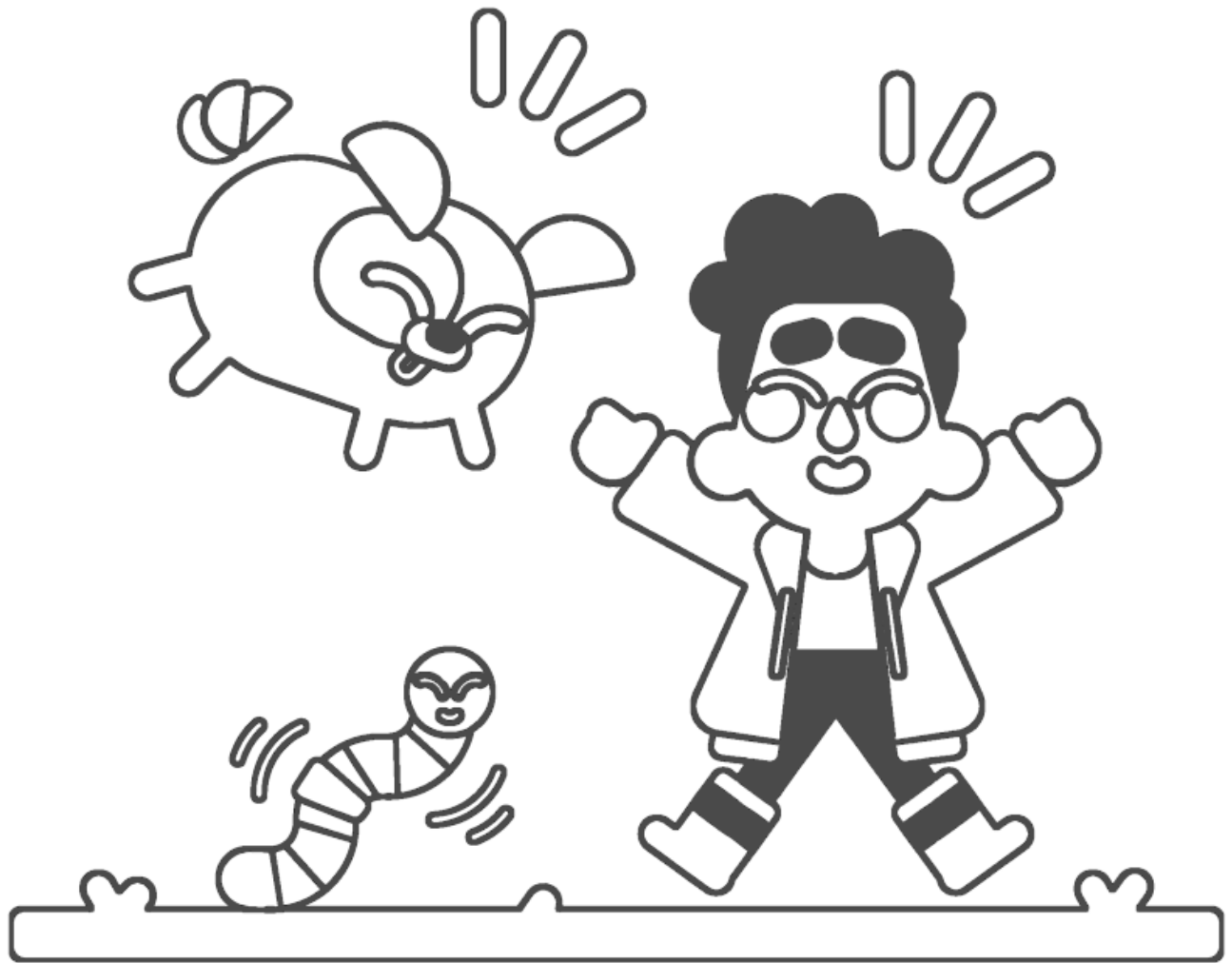

We love wiggly worms!

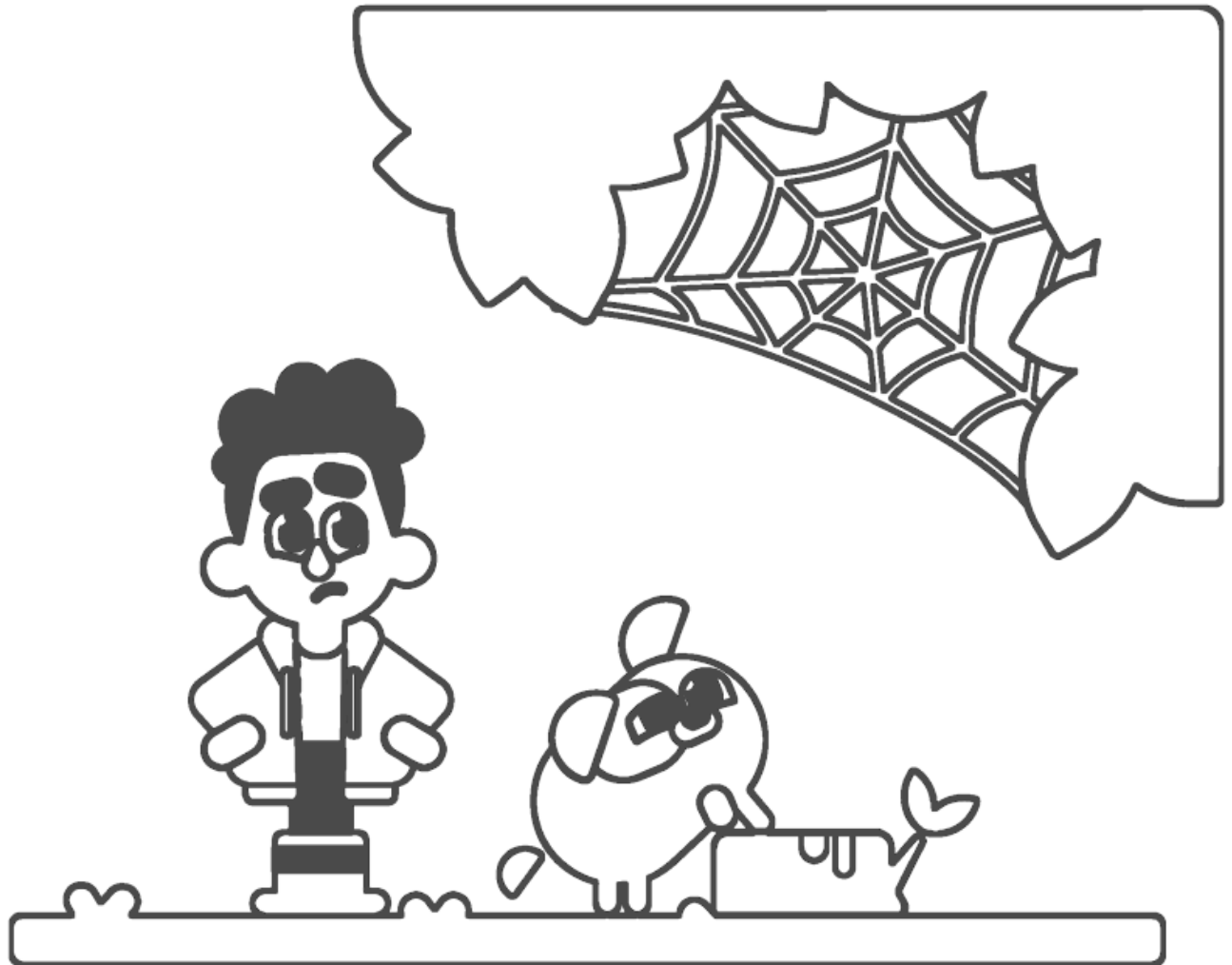

There's a web.

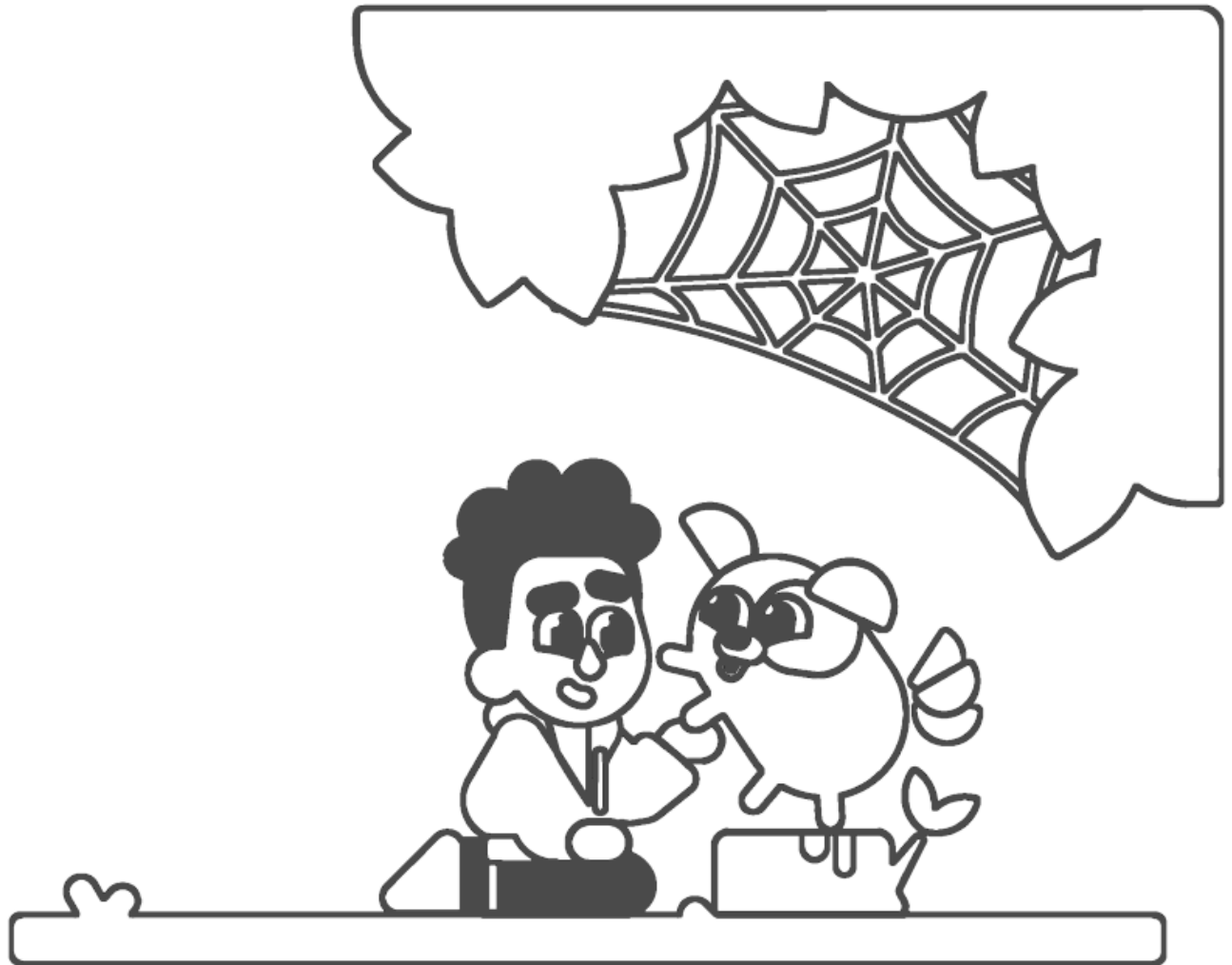

We love wispy webs!

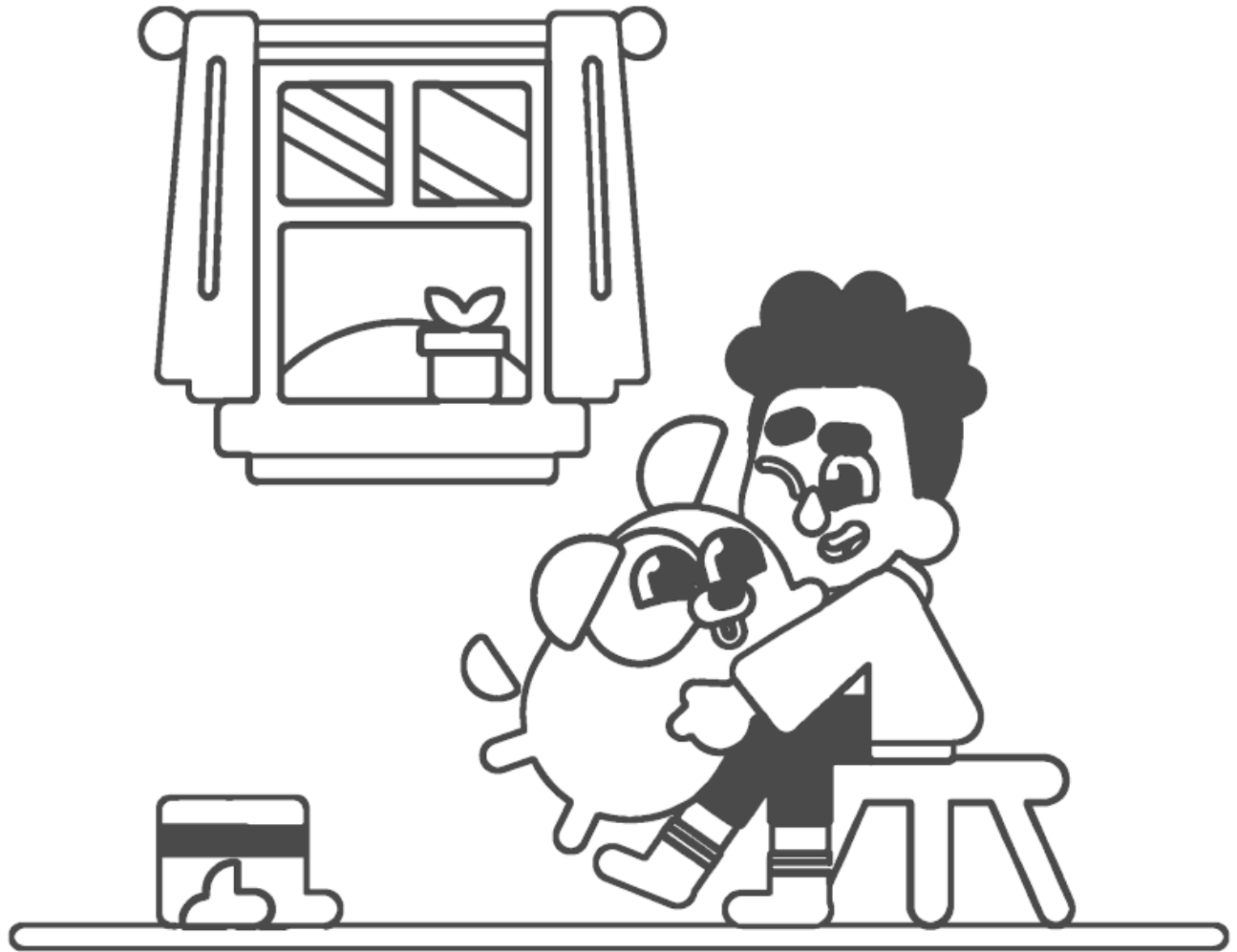

Wow! We had fun!

Y y

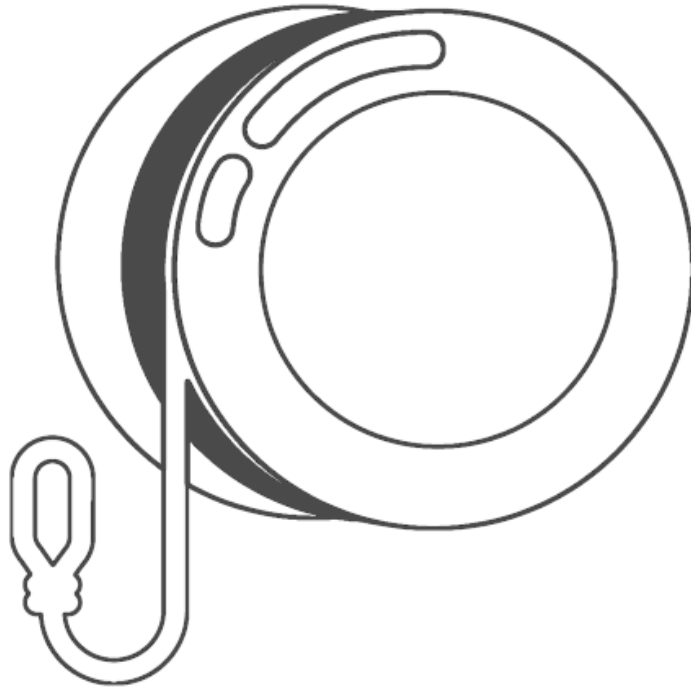

yoyo

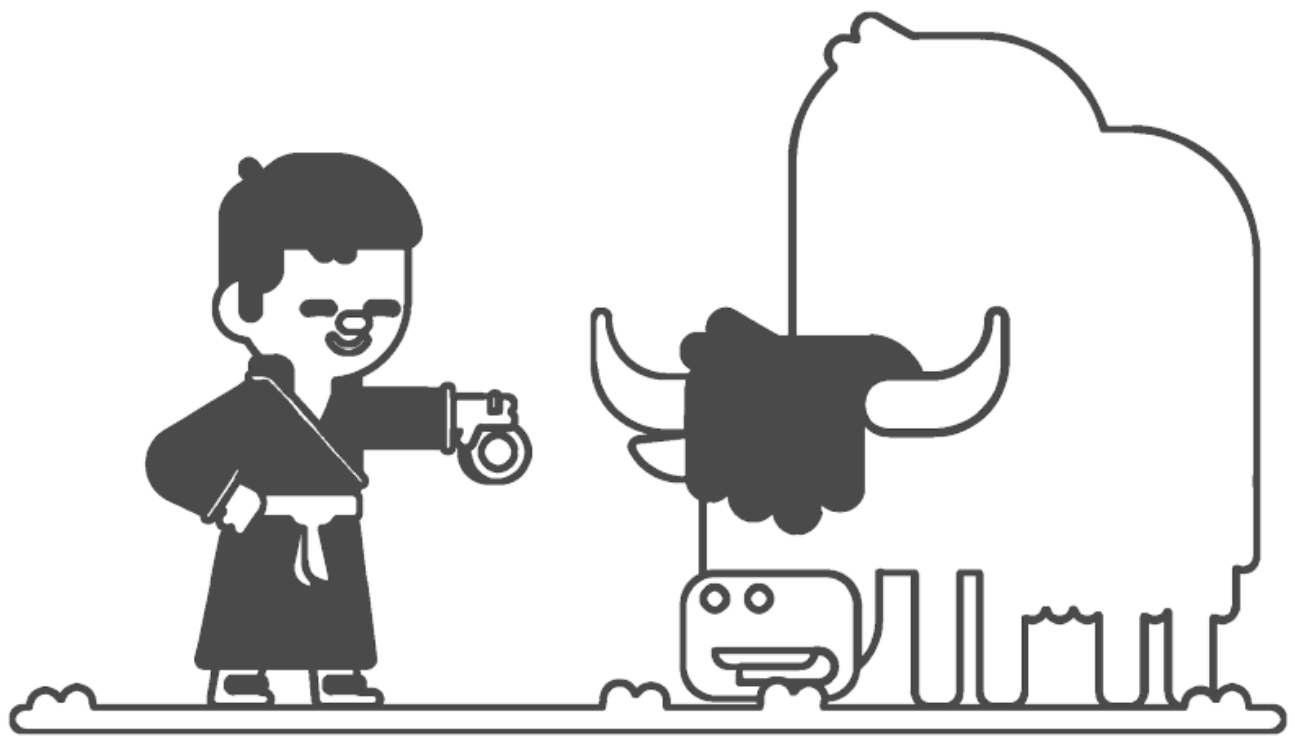

Yo-yoing is not so hard.

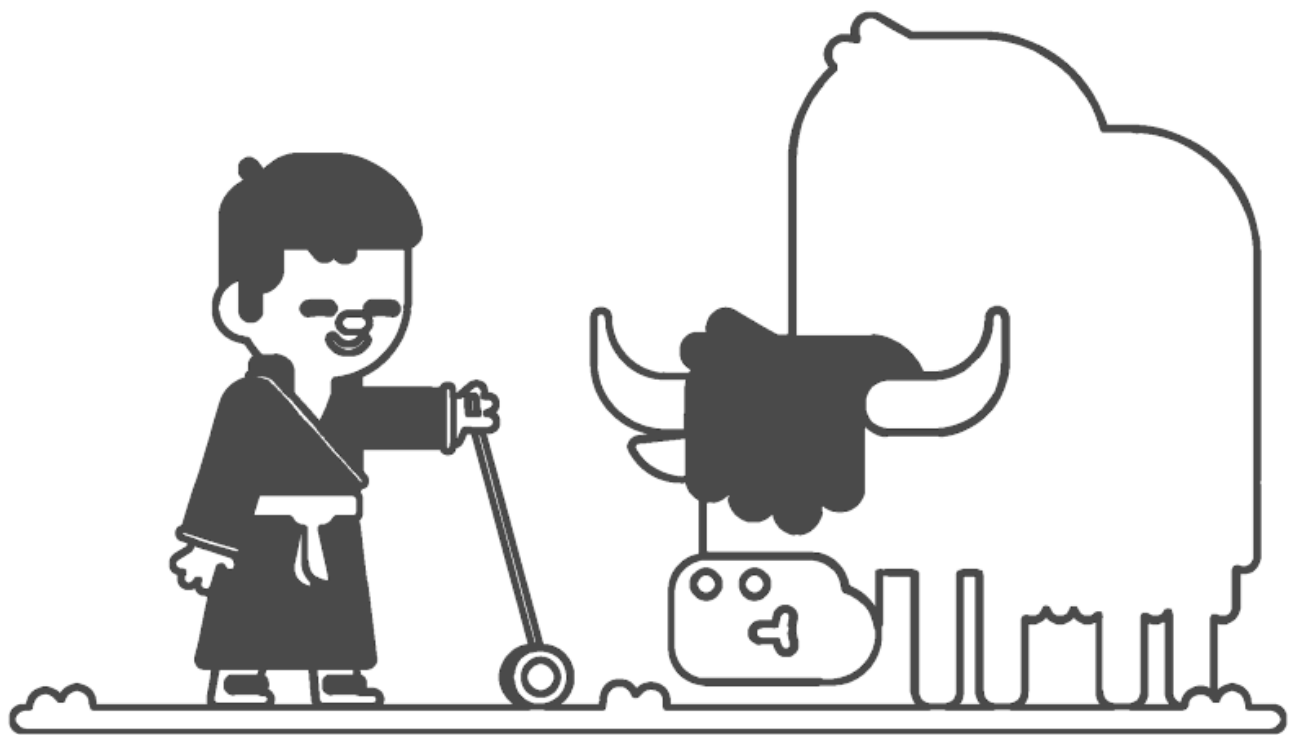

**You can yo-yo in the
yard.**

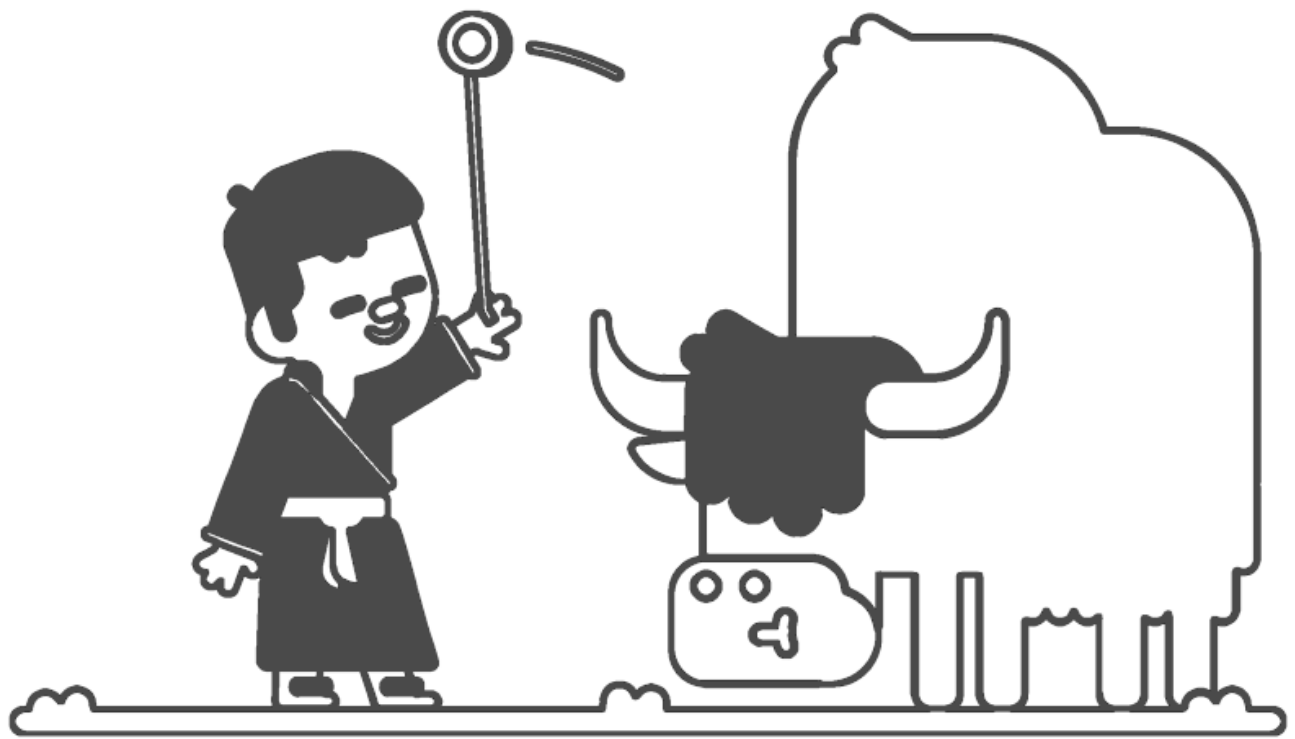

**You can yo-yo in the
air.**

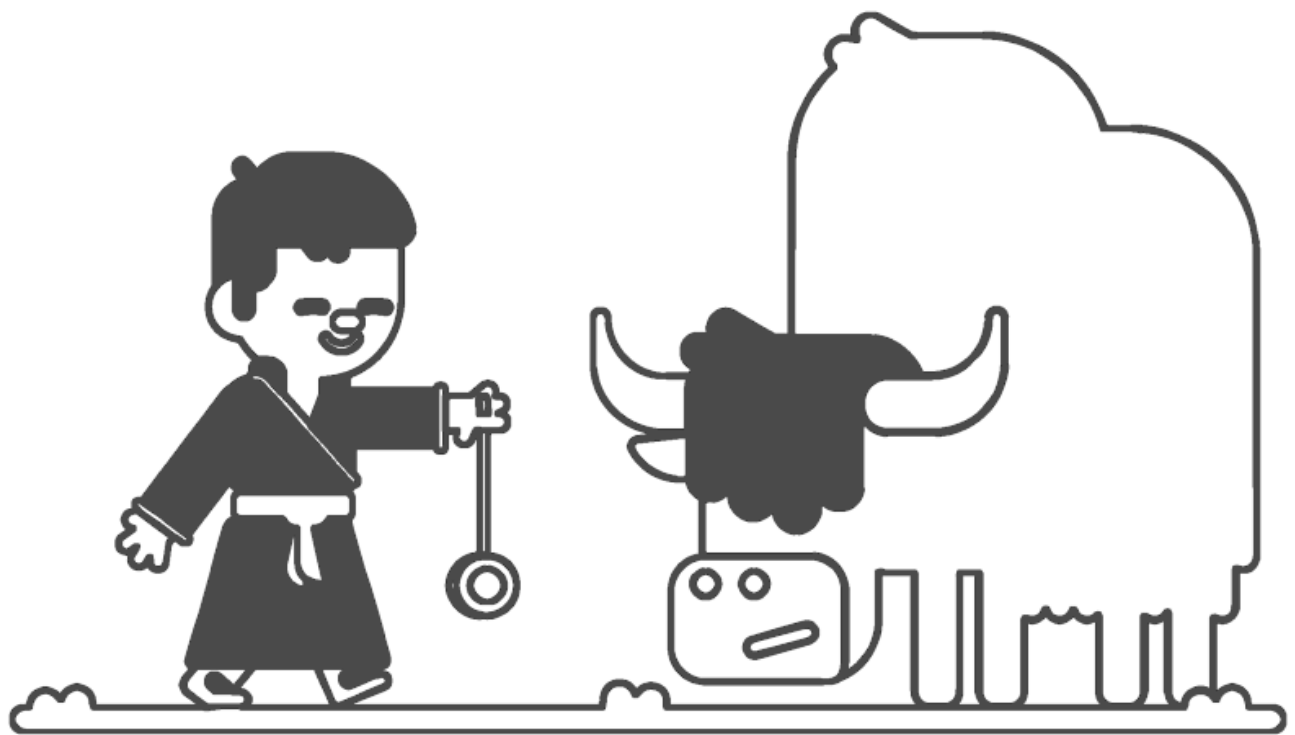

**You can yo-yo
anywhere.**

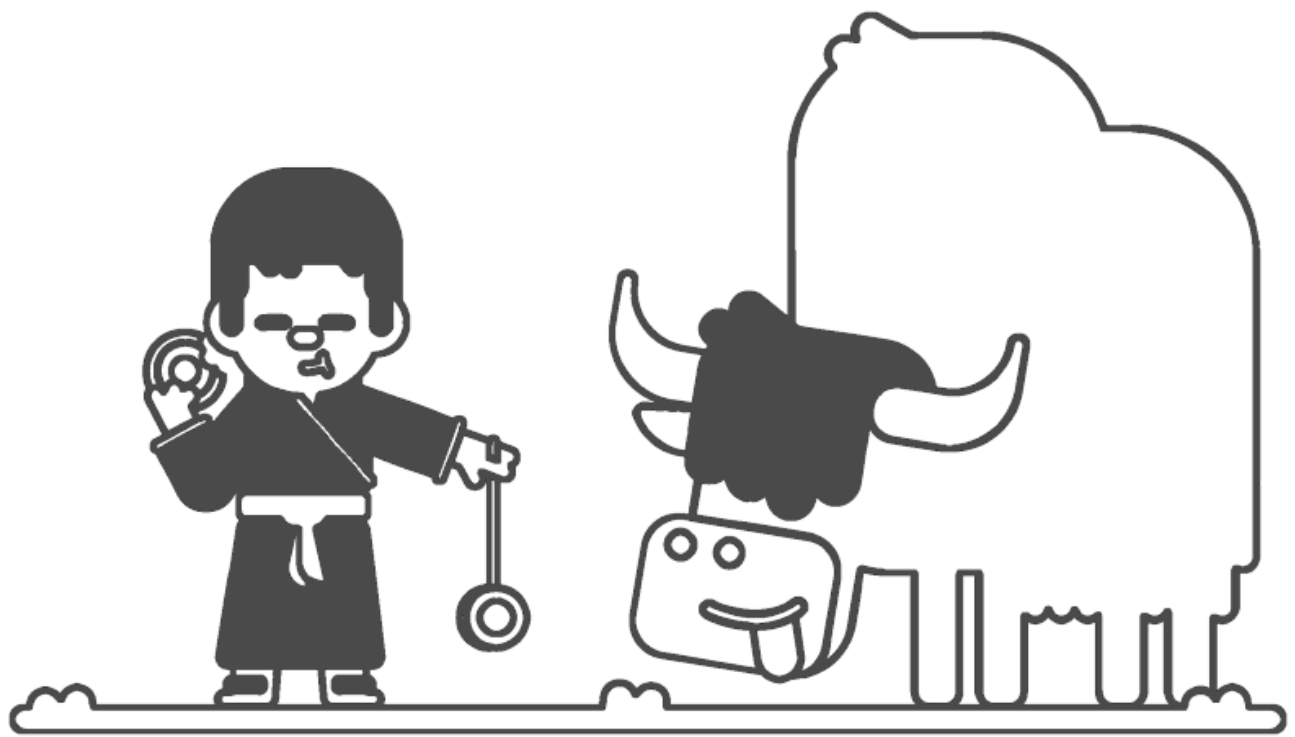

**You can yo-yo with a
yummy snack.**

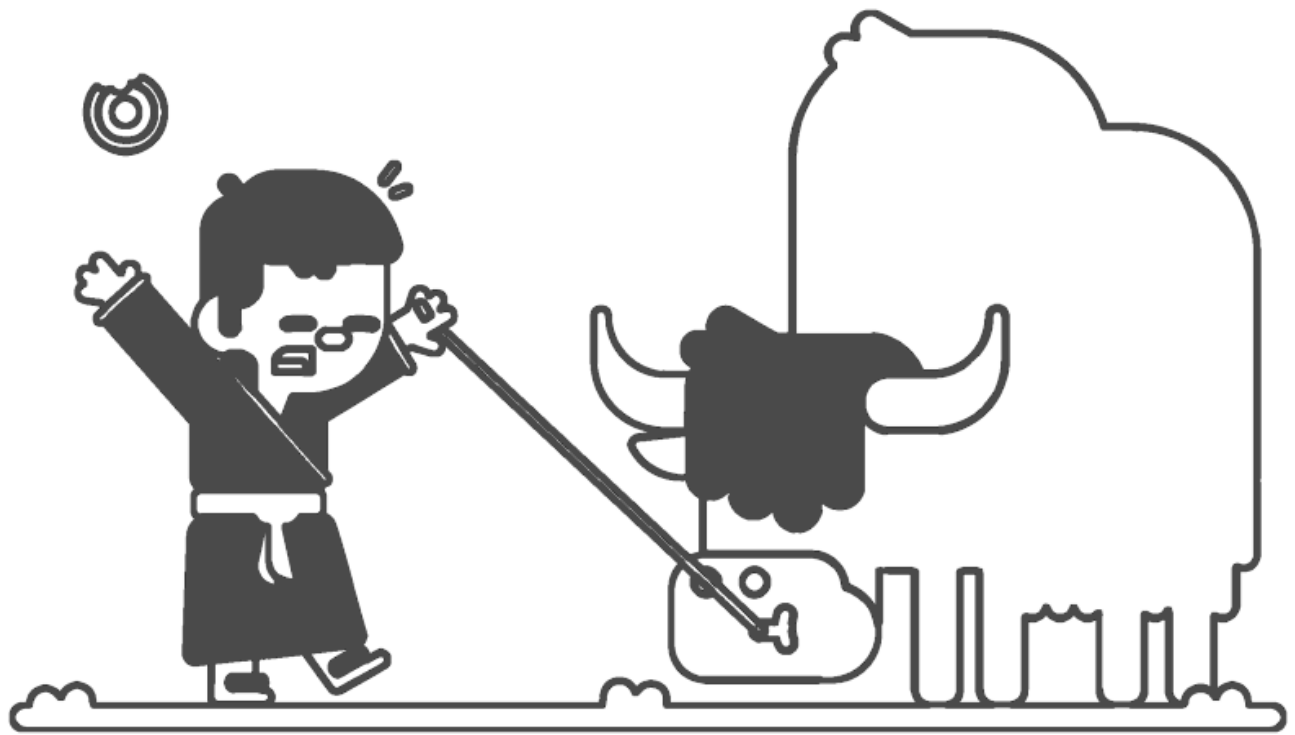

**Just don't yo-yo with a
hungry yak!**

Z z

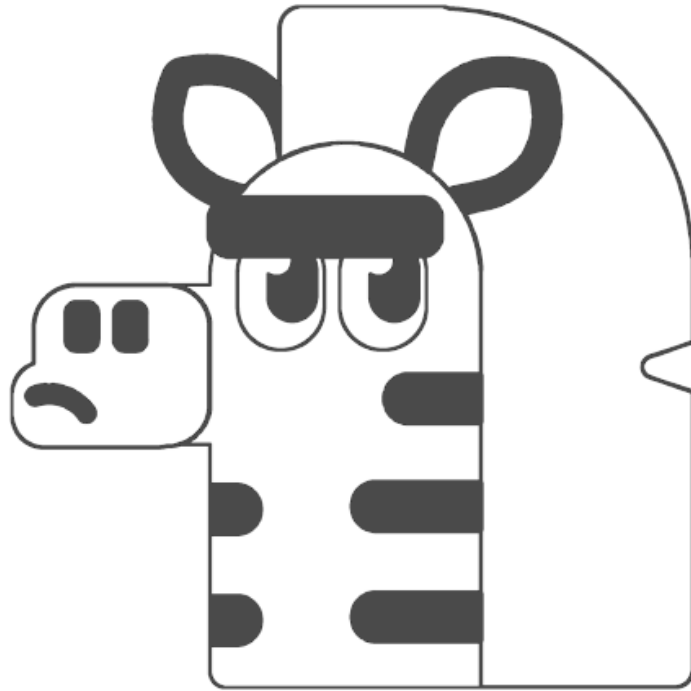

zebra

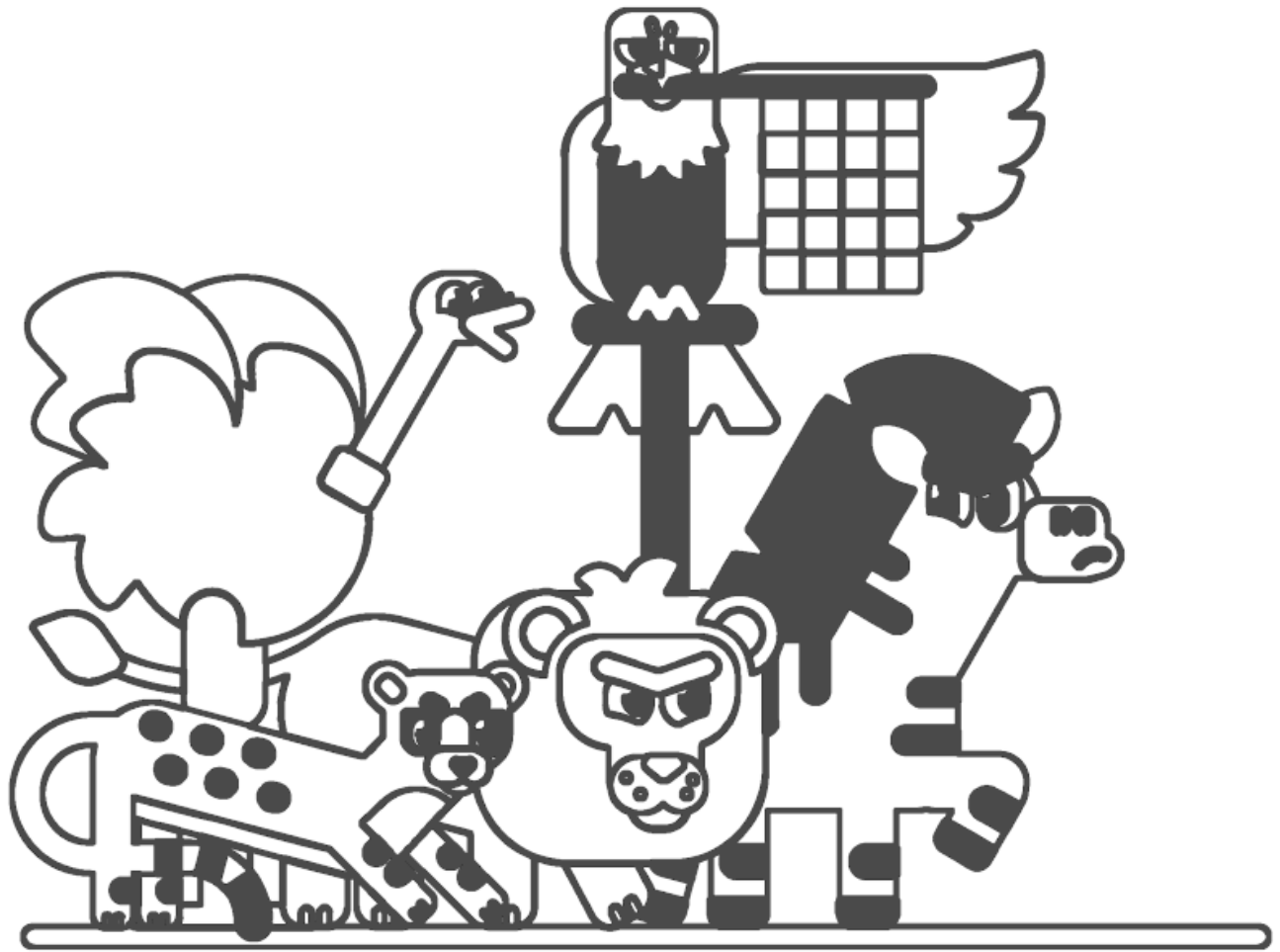

**Who will win the race
at the zoo?**



The zebra zooms away!

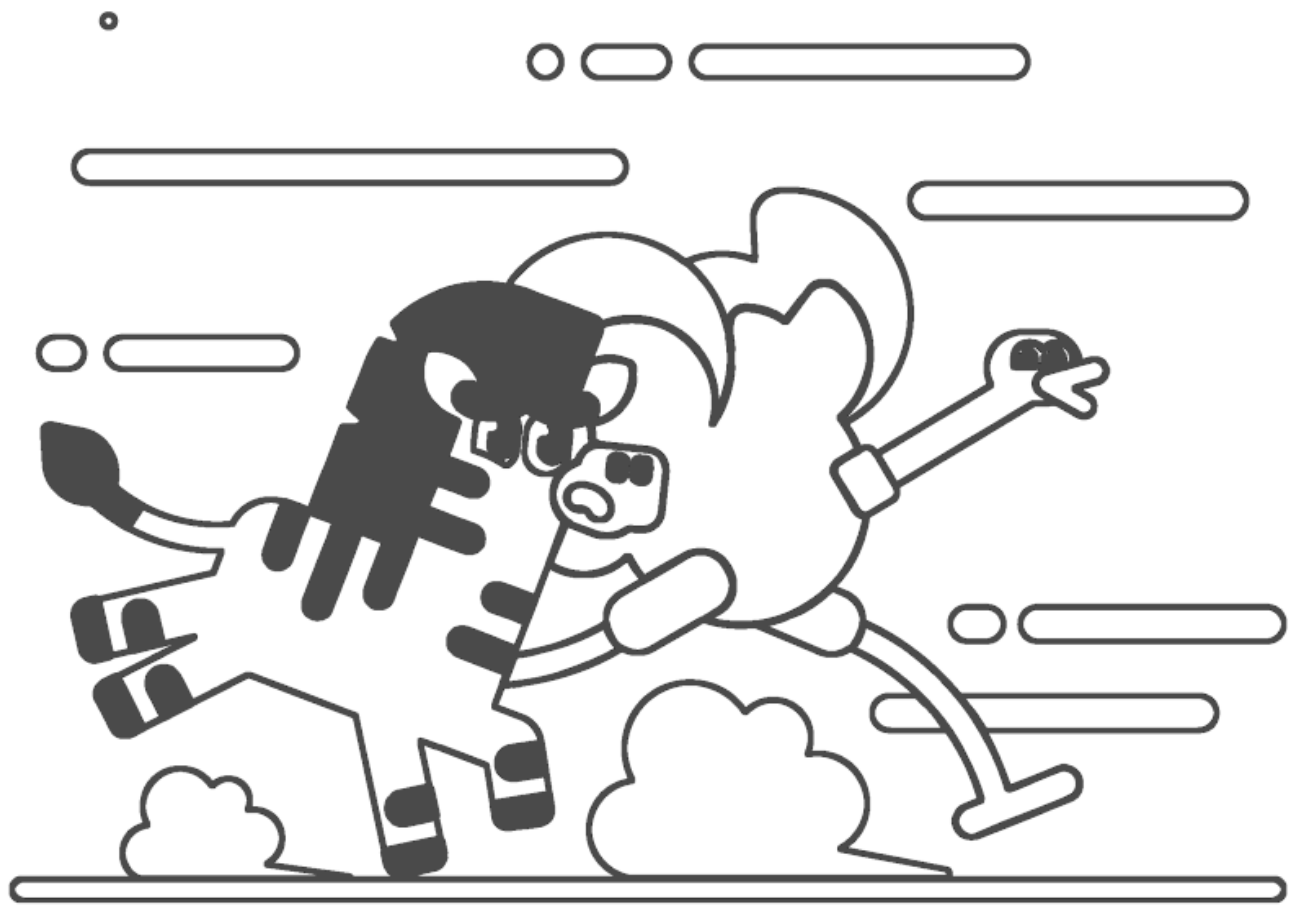

The ostrich zips by the zebra.

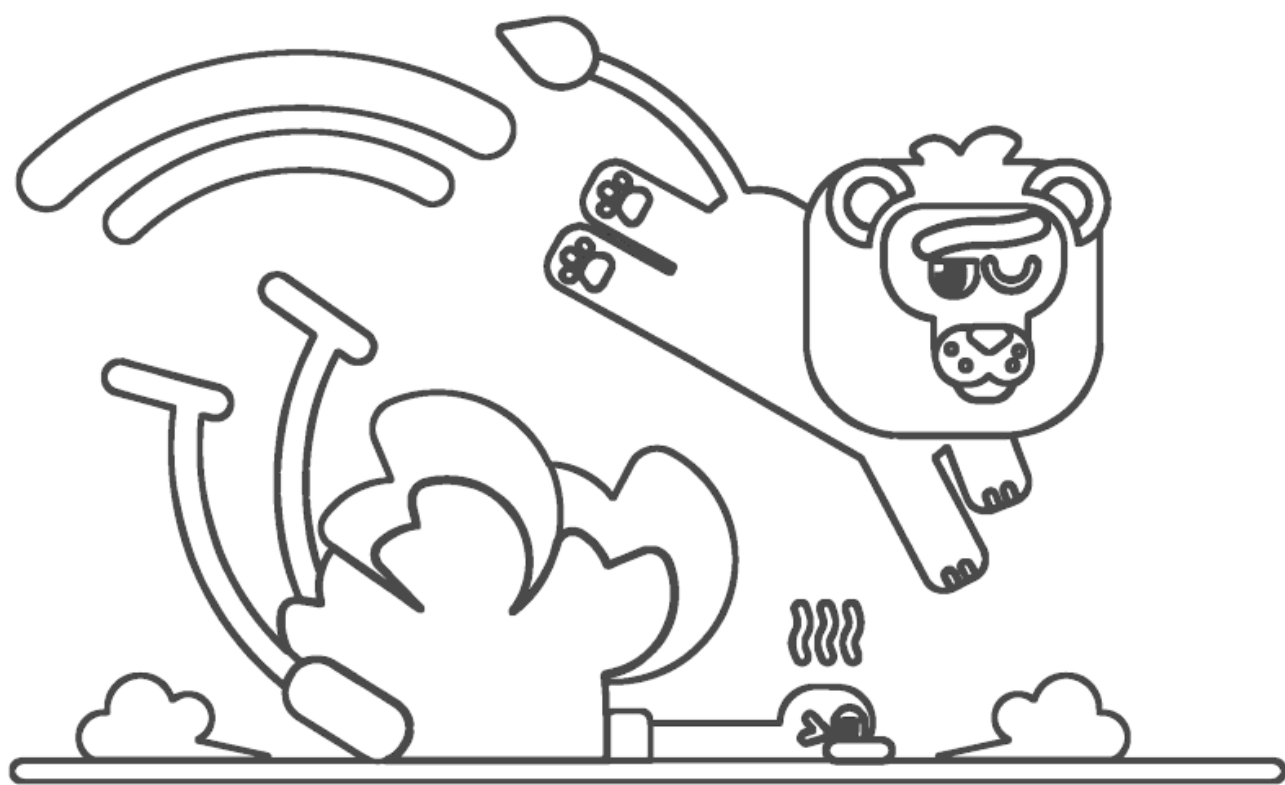

The lion zooms by the ostrich.

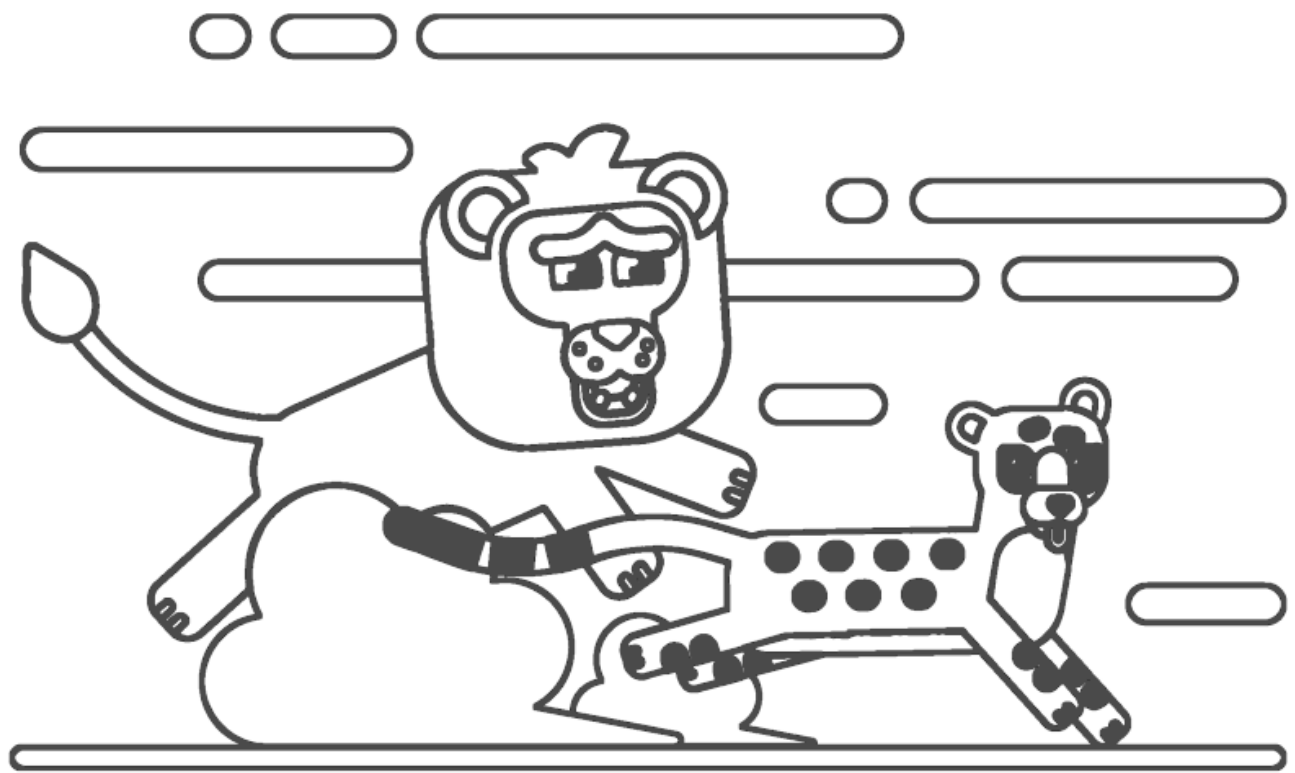

**The cheetah zips by the
lion.**

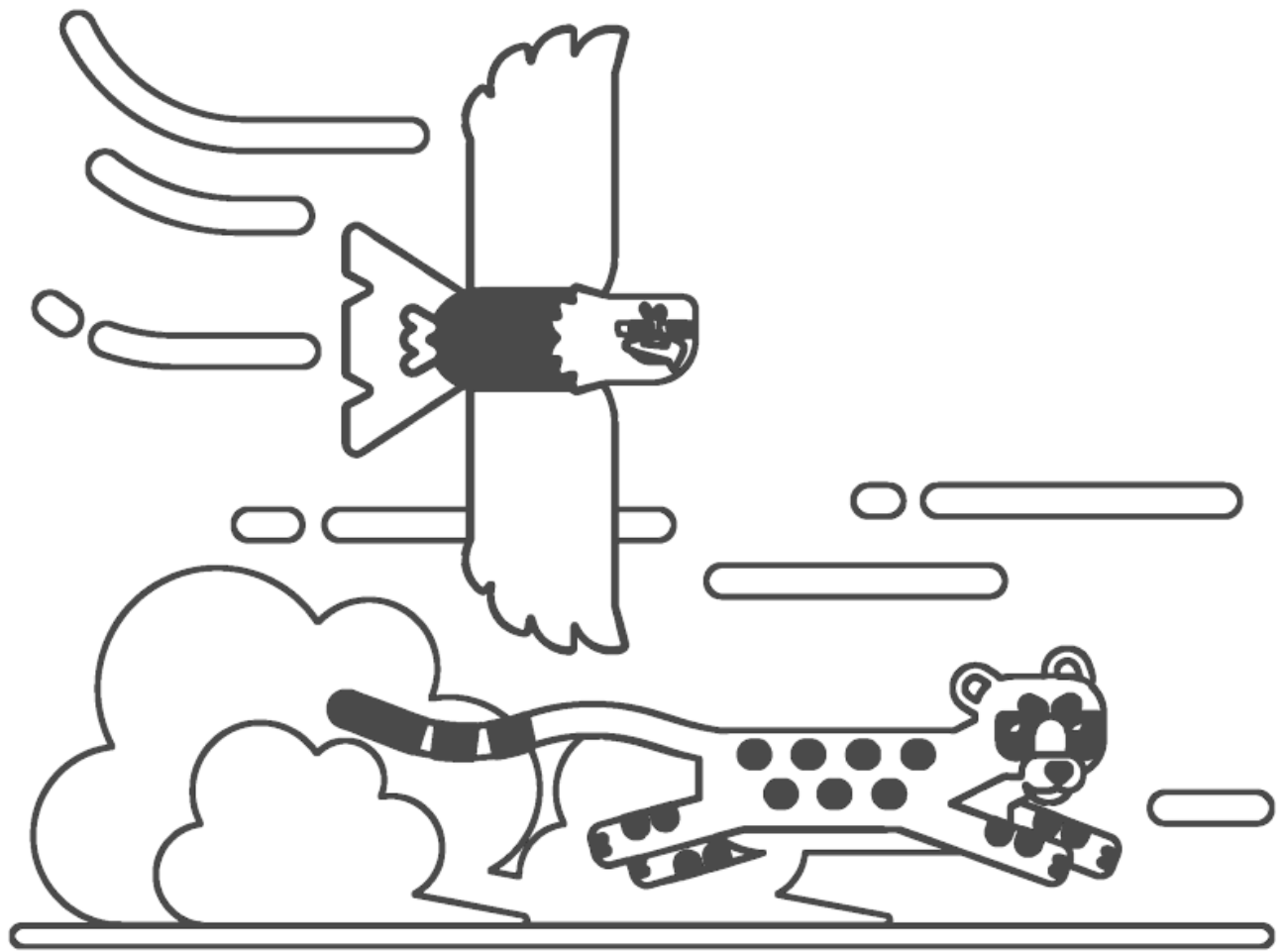

**Then, the eagle zooms
in...**

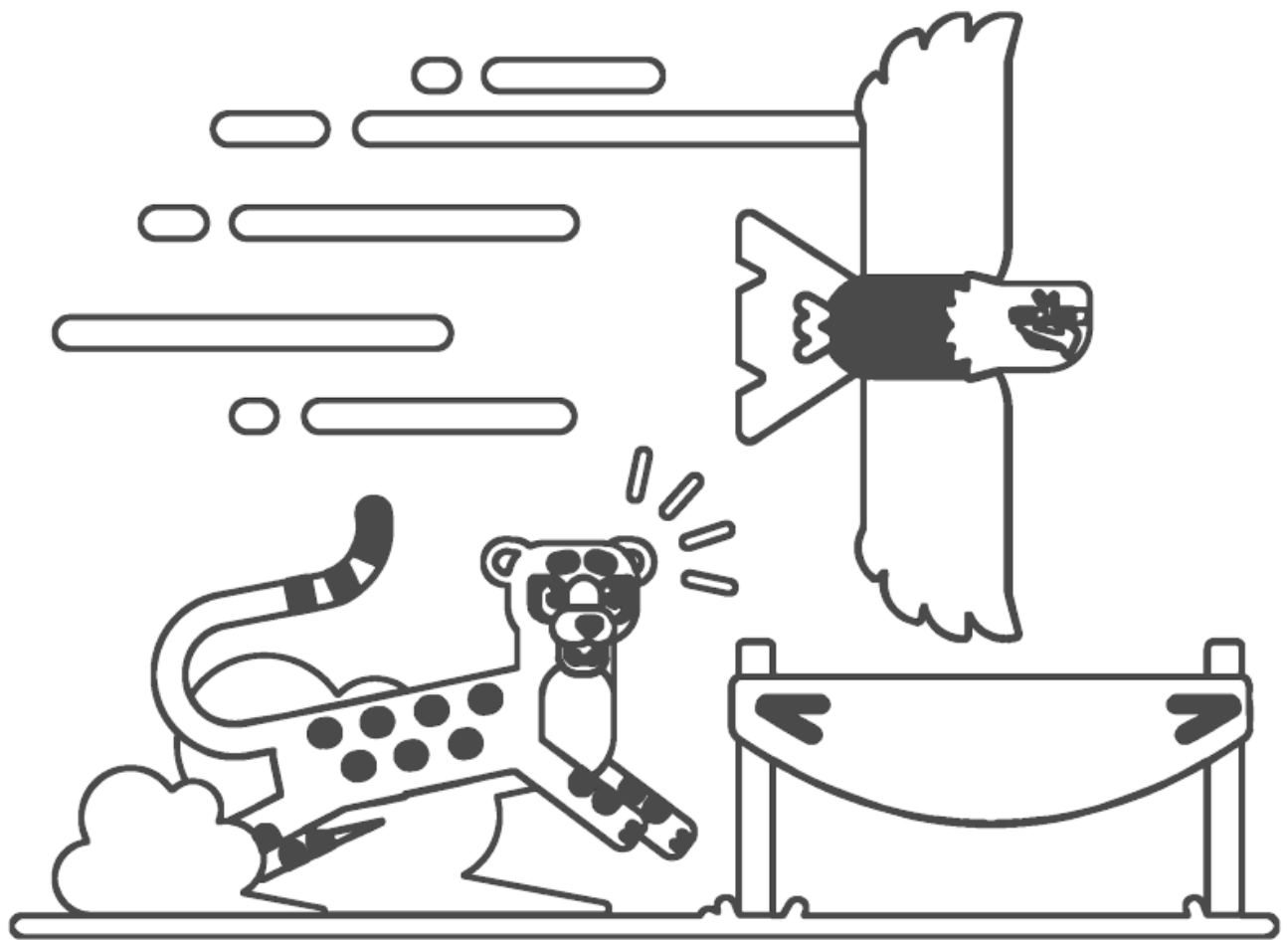

**...and zips by the
cheetah!**